



300 US t



197 ft



315 ft



345 ft

The most powerful 5-axle crane on the market

LTM 1250-5.1

Mobile crane
Grue mobile

LIEBHERR

Mobile and crawler cranes



Technical data

Caractéristiques technique

Dimensions	
Encombrement	3
Mobile crane	
Grue mobile	4-5
Fuel saving and noise reduction	
Economie de carburant et réduction du bruit	6-7
Crane data	
Dates de la grue	8
Counterweight	
Contrepoids	9
On-road driving	
Déplacement sur route	10
Jobsite driving	
Déplacement sur chantier	10
Lift cab	
Cabine élévatrice	11
Transportation plan – Example	
Plan de transport – Exemple	12-13
Variable boom system	
Systèmes de flèche variables	14-15
Boom/jib combinations	
Configurations de flèche	16-17
T	18-27
TNZK	28-43
TVNZK	44-77
TS	78-85
TNZF	86-100
Equipment	
Equipement	101-102
Description of symbols	
Explication des symboles	103
Remarks	
Remarques	104

Dimensions Encombrement

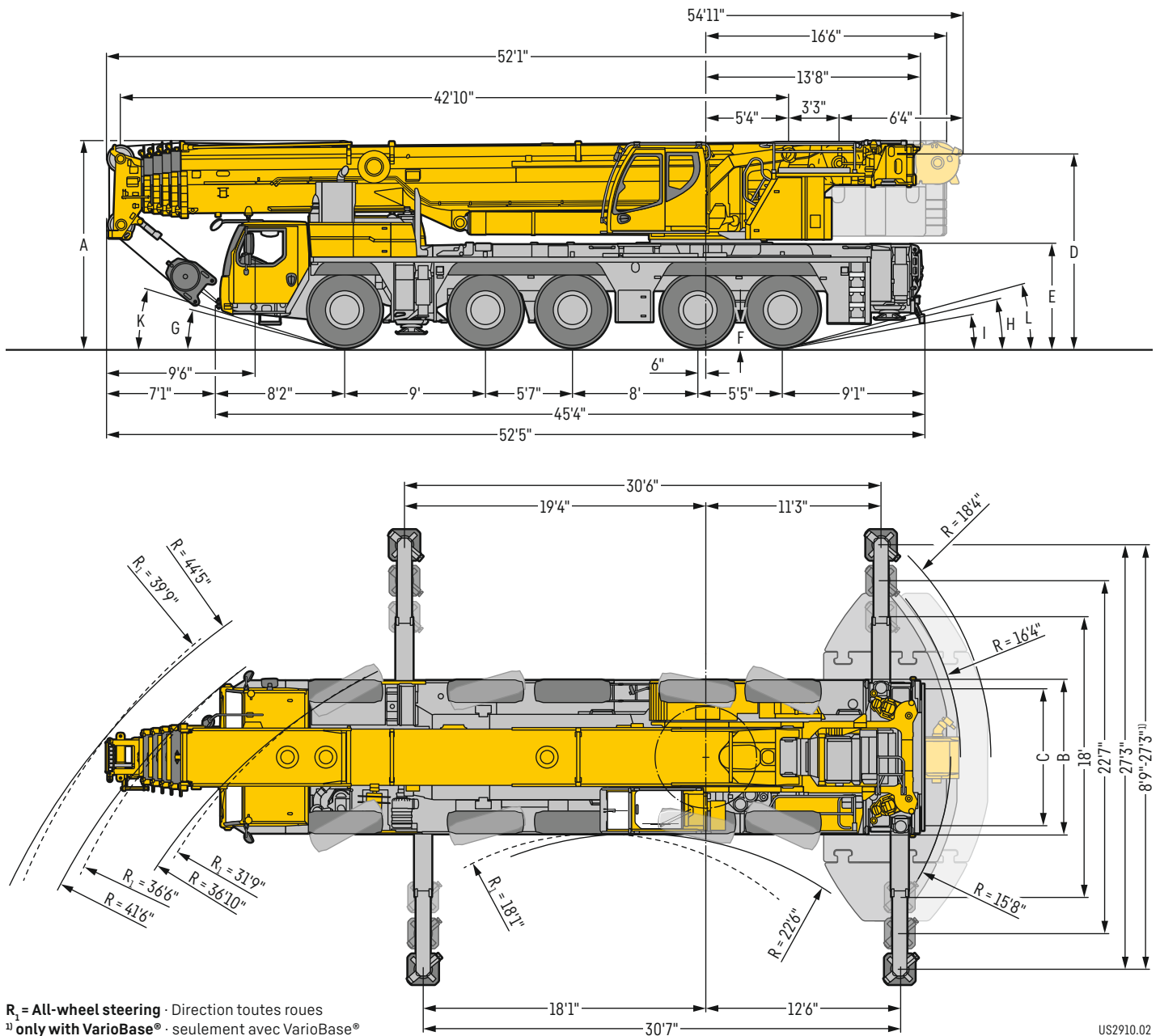

Dimensions · Encombrement

	A	A 5"*	B	C	D	E	F	G	H	I	K	L
445/95 R 25 (16.00 R 25)	13'1"	12'9"	9'10"	8'4"	12'4"	6'7"	1'5"	15°	13°	10°	17°	14°
525/80 R 25 (20.5 R 25)	13'1"	12'9"	10'2"	8'5"	12'4"	6'7"	1'5"	15°	13°	10°	17°	14°

* lowered · abaissé

LTM 1250-5.1

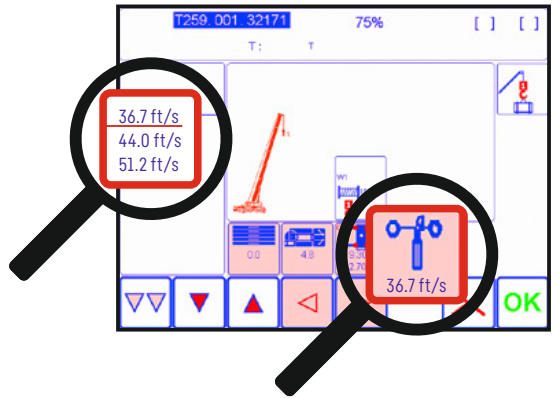

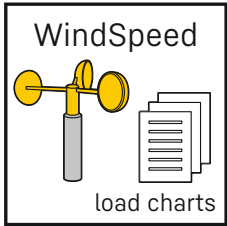

Increased flexibility and safety by using lifting capacity tables with different maximum wind speeds.

Une flexibilité et une sécurité accrues grâce aux tableaux de charge avec différentes vitesses de vent autorisées.

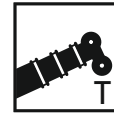

197 ft



18 ft - 118 ft

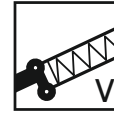

2 x 23 ft



26 ft - 164 ft



13 ft - 151 ft

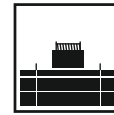

194,000 lb



400 KW / 544 h.p.

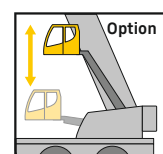
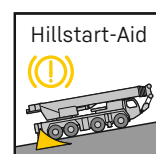
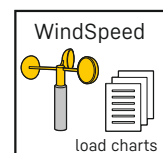
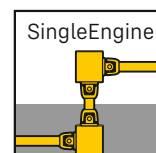
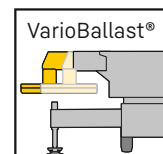
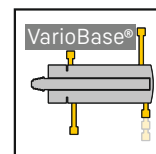

Fuel saving and noise reduction

Economie de carburant et réduction du bruit

ECOdrive
TRAXON

Driving strategy in the carrier with ECO- or Power-mode to reduce noise and fuel

L'adaptation du mode de déplacement avec le mode ECO ou le mode Puissance permet de réduire le niveau sonore et la consommation de carburant

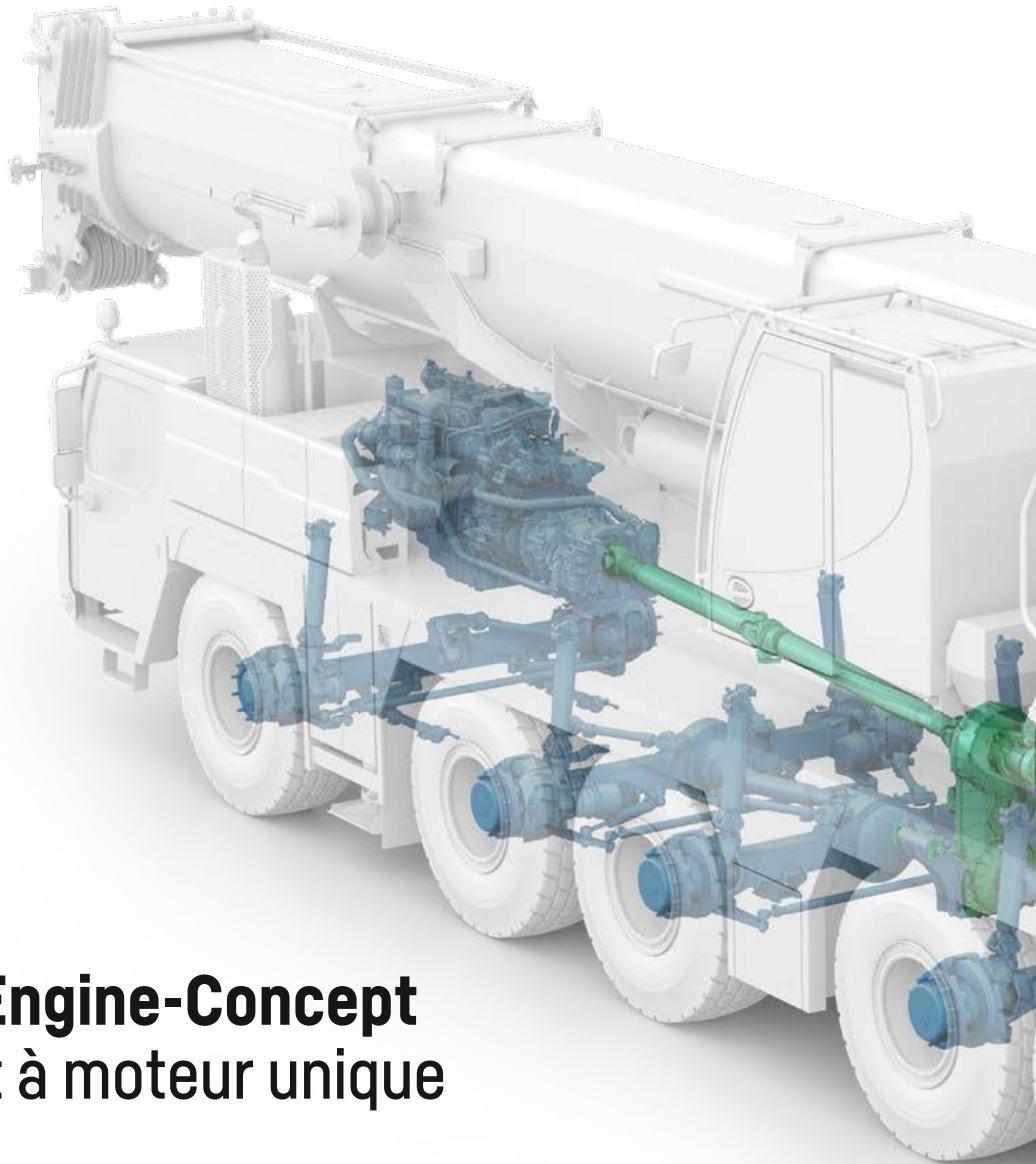

Innovative One-Engine-Concept

Concept innovant à moteur unique

Drive from chassis engine via a mechanical shaft with special high efficiency factor

Increased effectiveness and reduced maintenance expenditure

Entraînement du moteur du châssis par le biais d'un arbre mécanique particulièrement performant

Rentabilité accrue et entretien nettement réduit

ECOmode

Reduced fuel consumption due to automatic disengaging of the complete pump drive at engine idling with automatic speed adjustment



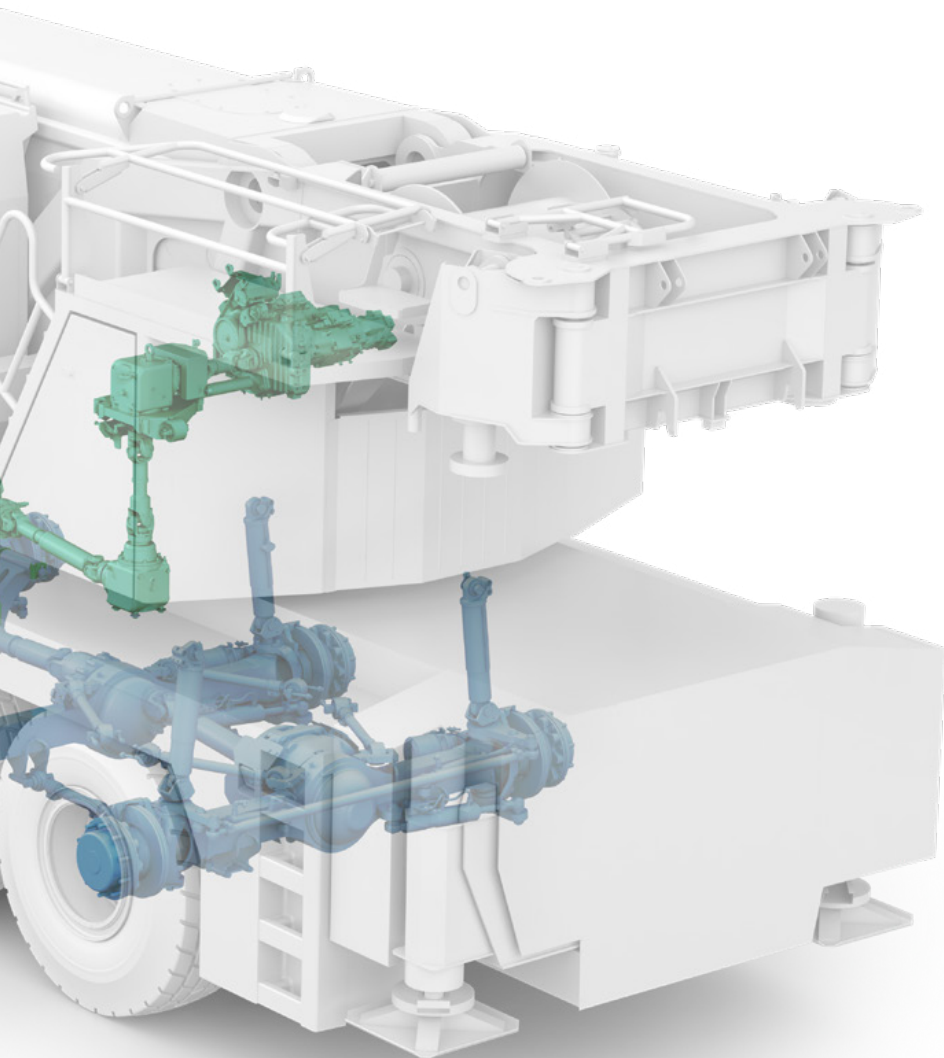

Réduction de la consommation de carburant par désengagement automatique de l'entraînement complet de la pompe en mode ralenti avec adaptation automatique du régime











Crane data

Dates de la grue

Hook block - Moufles à crochet

			
332,900 lb	9	16	4,400 lb
314,480 lb	7	15	3,750 lb
237,450 lb	5	11	3,530 lb
155,650 lb	3	7	3,200 lb
68,780 lb	1	3	1,850 lb
23,150 lb	-	1	1,100 lb

Crane carrier - Châssis porteur









					
445/95 R 25 (16.00 R 25)	0.3	53	56.5 %		12 / R2
525/80 R 25 (20.5 R 25)	0.3	53	56.5 %		4 / R2

Theoretical gradeability - aptitude théorique en pente

Max. supporting forces - Forces d'appui max.

		
F _{max}	185,000 lb	255,000 lb

Crane superstructure - Partie tournante

			
 0 - 423 ft/min single line - au brin simple	23 mm	1150 ft	23,605 lb
 0 - 423 ft/min single line - au brin simple	23 mm	920 ft	23,605 lb
 0 - 1.2 rpm			
 approx. 55 seconds to reach 82° boom angle env. 55 s jusqu'à 82°			
 approx. 440 seconds for boom extension from 43 ft - 197 ft env. 440 s pour passer de 43 ft - 197 ft			

VarioBallast®

Counterweight radius

Rayon de contrepoids

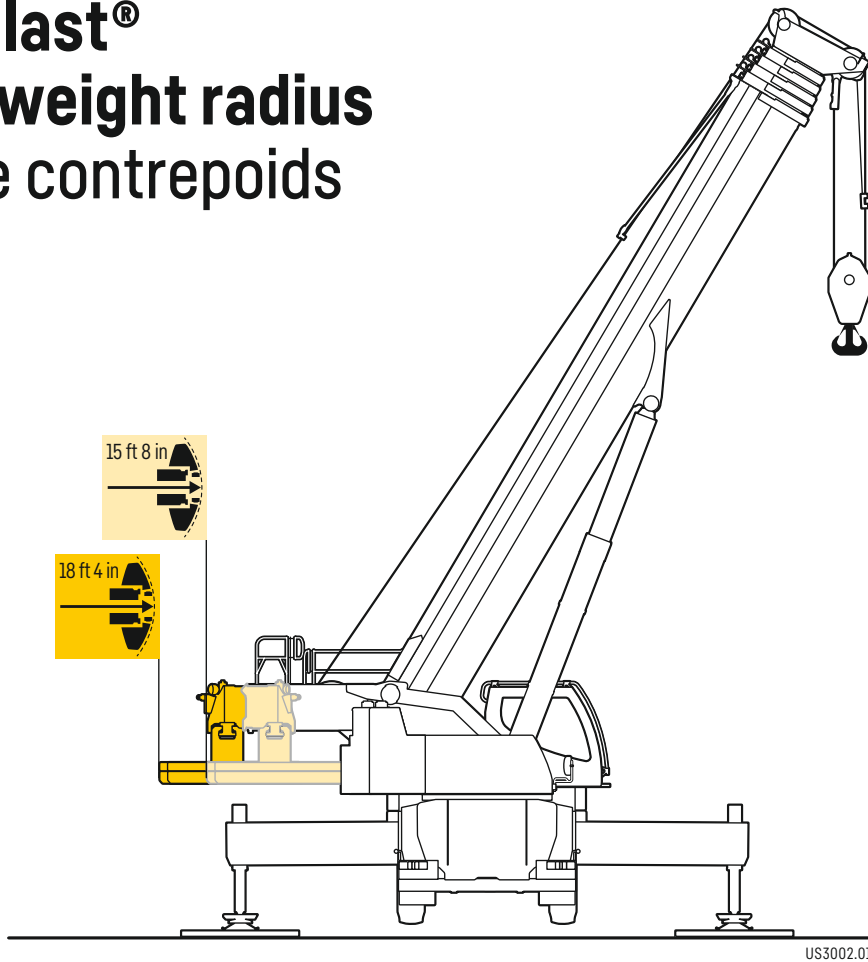

Counterweight

Contrepoids



Technically transportable
Transport techniquement simplifié

Additional counterweight
Contrepoids additionnel

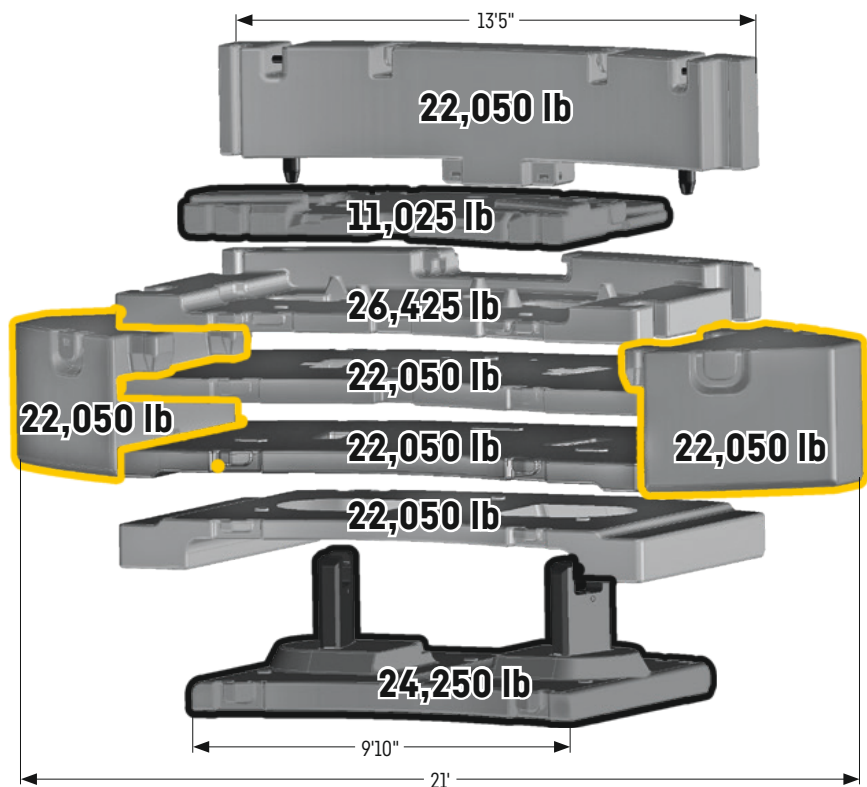

On-road driving

Déplacement sur route

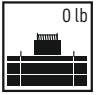
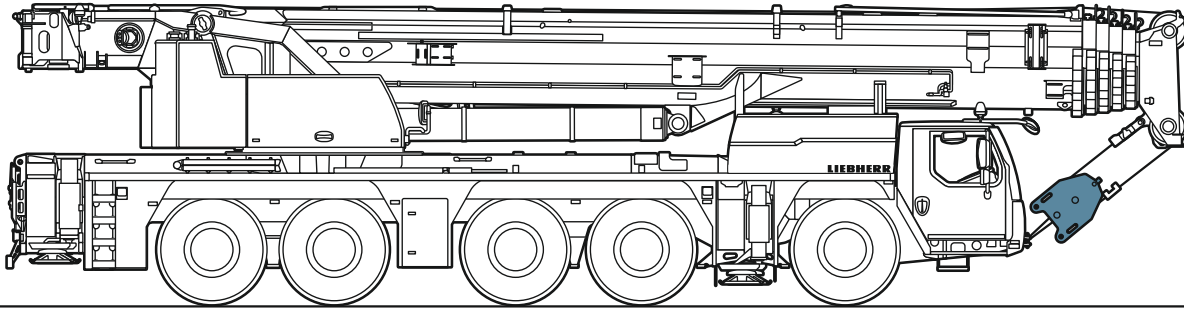

≤ 132,300 lb

≤ 26,450 lb ≤ 26,450 lb ≤ 26,450 lb ≤ 26,450 lb ≤ 26,450 lb

Jobsite driving

Déplacement sur chantier

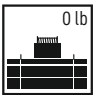
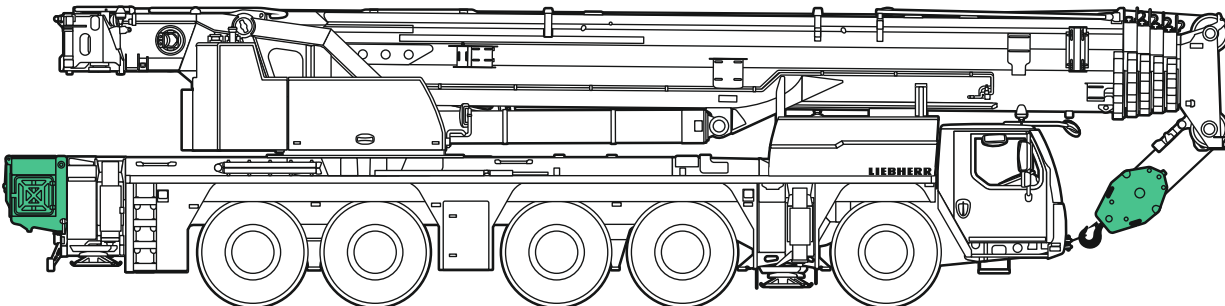

≤ 136,700 lb

≤ 28,650 lb ≤ 28,650 lb ≤ 28,650 lb ≤ 28,650 lb ≤ 28,650 lb

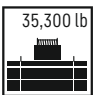
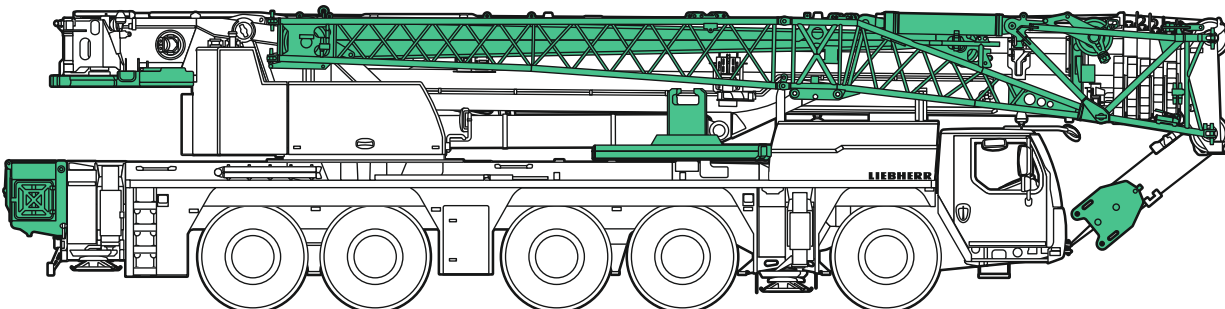

≤ 180,800 lb

≤ 36,400 lb ≤ 36,400 lb ≤ 36,400 lb ≤ 36,400 lb ≤ 36,400 lb

US2967.01

Lift cab (optional)

Cabine élévatrice (en option)

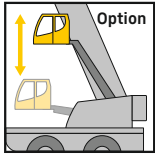

Better view

Meilleur champ de vision

Increased safety

Sécurité accrue

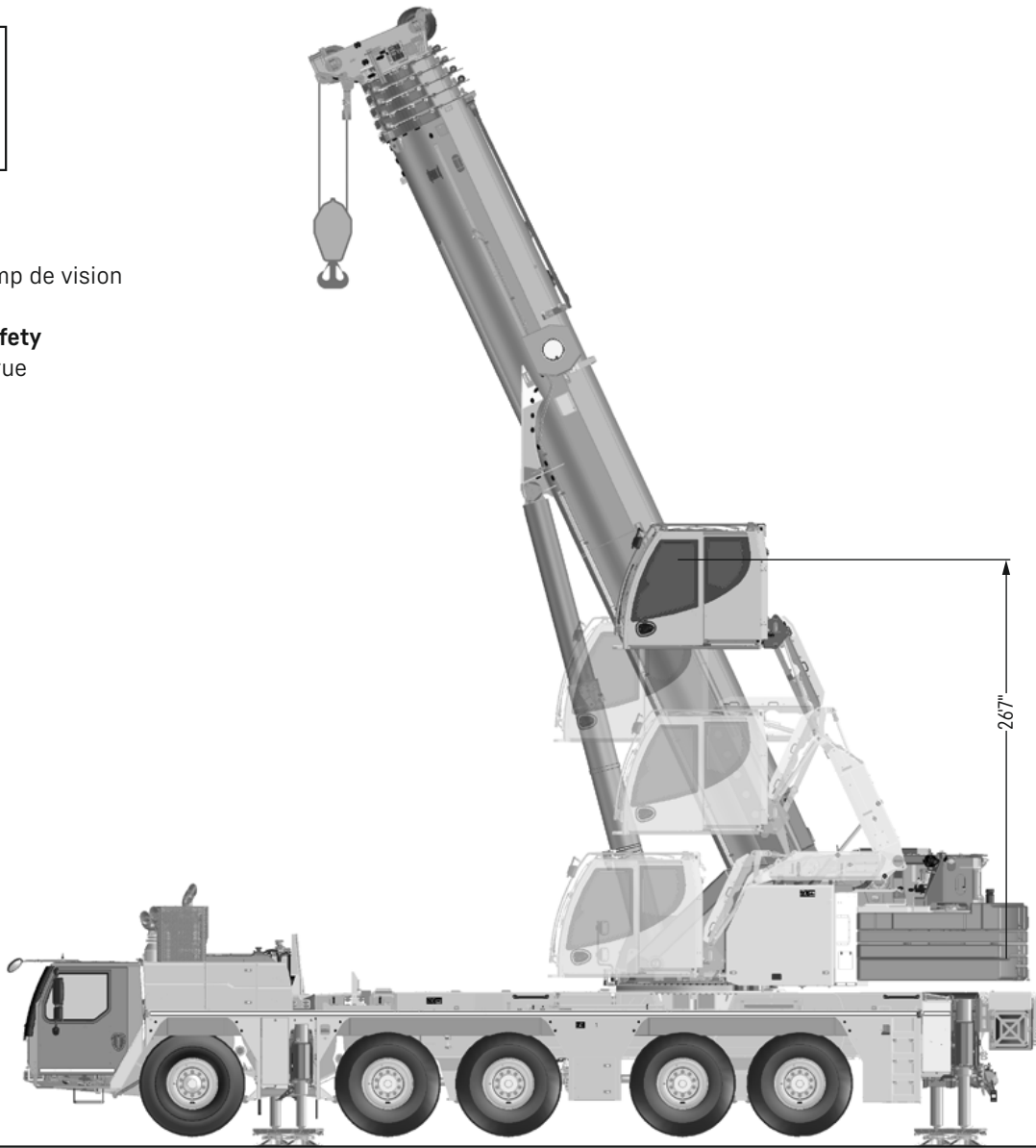

US3237.01

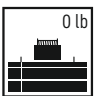
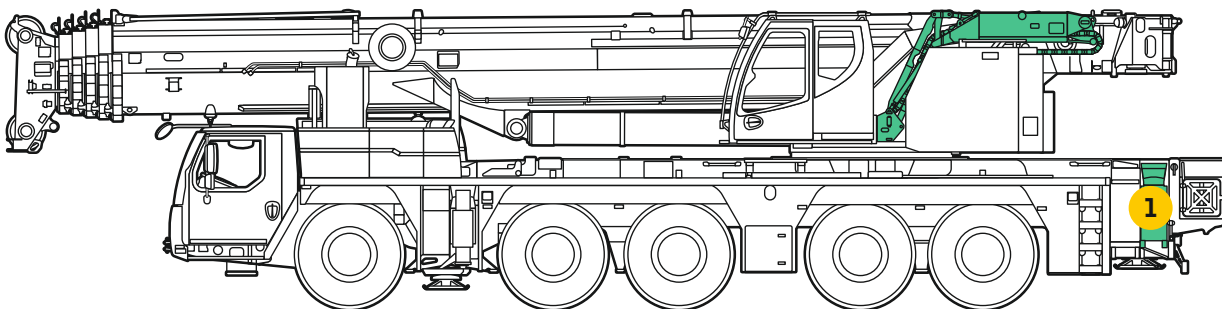

≤ 132,300 lb

≤ 26,450 lb ≤ 26,450 lb ≤ 26,450 lb ≤ 26,450 lb ≤ 26,450 lb

US3238.02

1 without rear left sliding strut · sans barre coulissante à l'arrière à gauche

Transportation plan – Example

Plan de transport – Exemple

20 t / 44,100 lb

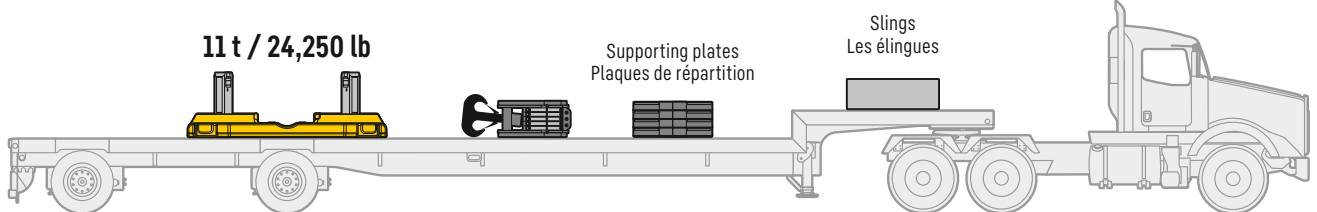

20 t / 44,100 lb

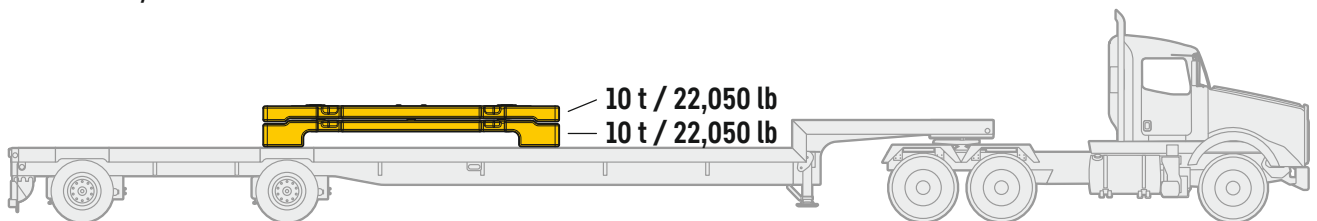

20 t / 44,100 lb

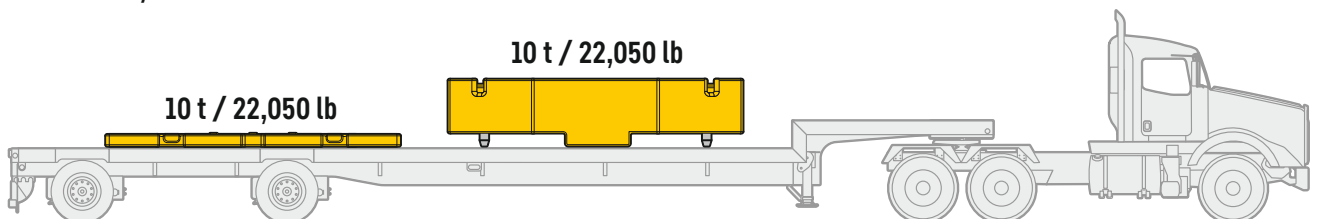

20 t / 44,100 lb

Double swing-away jib
Flèche pliante double

5 t / 11,025 lb

12 t / 26,450 lb

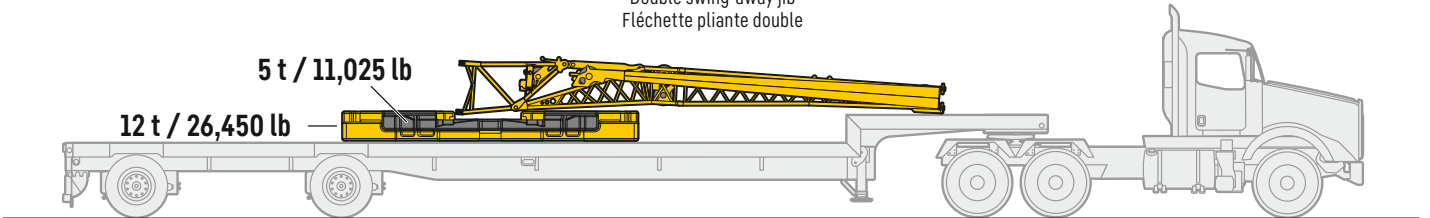

20 t / 44,100 lb

10 t / 22,050 lb

10 t / 22,050 lb

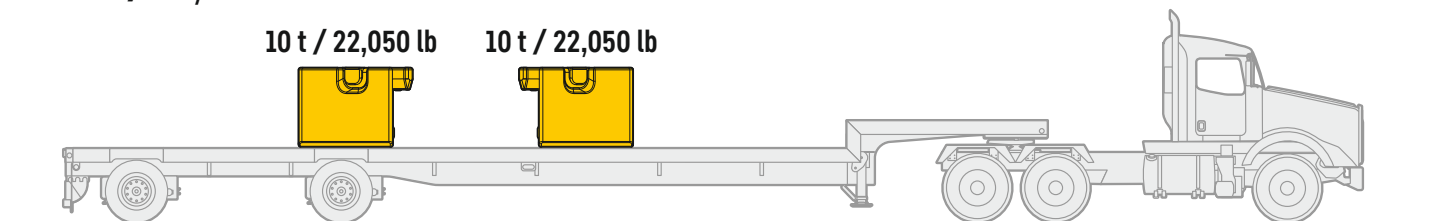

S2969.03

Variable boom systems

Systèmes de flèche variables

TVK
TVNZK

TNZF

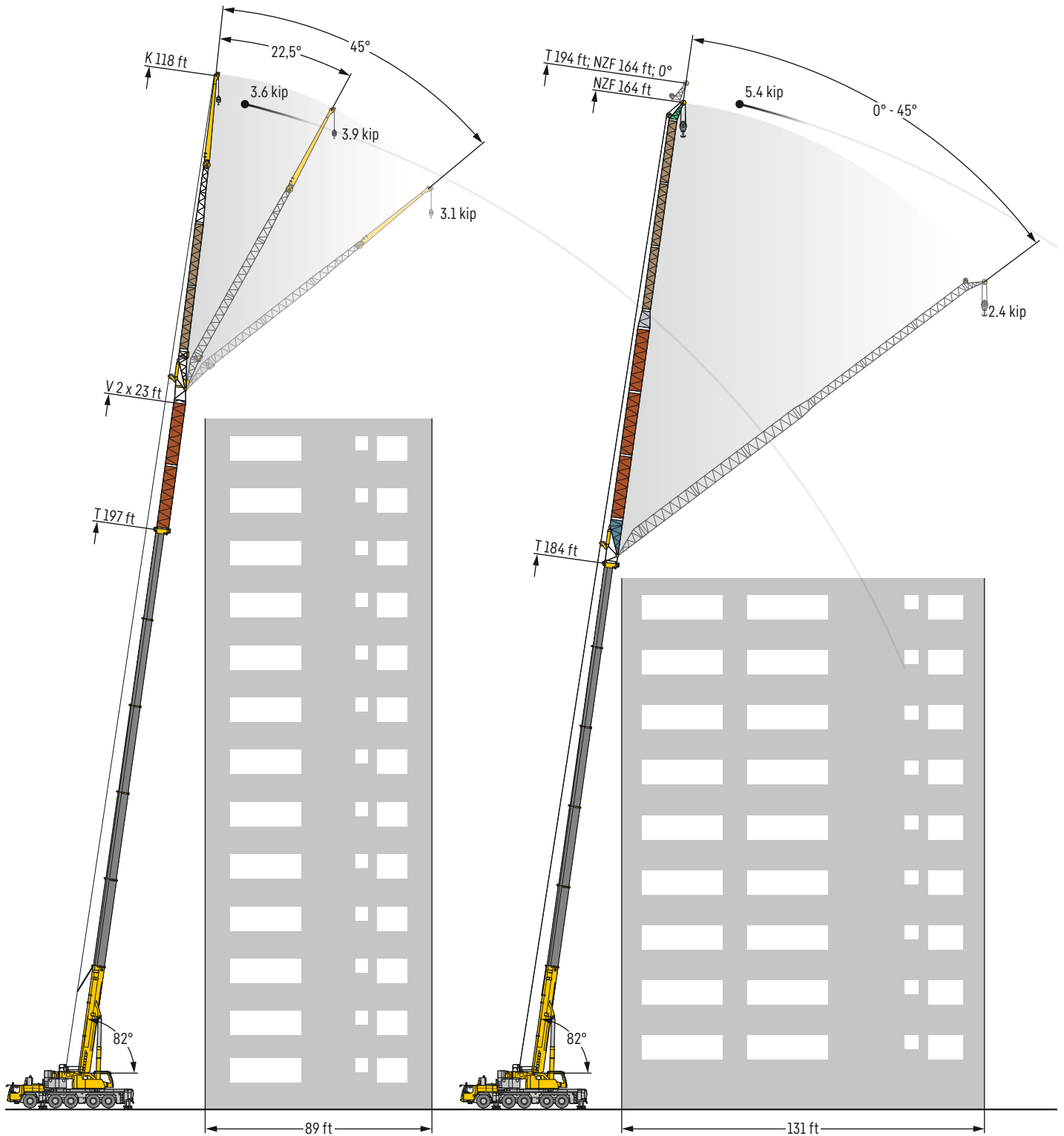

TS

TVK TVNZK

K 18 ft,
40 ft - 72 ft, 95 ft, 118 ft
0°, 22,5°, 45°

NZK 18 ft,
40 ft - 72 ft, 95 ft, 118 ft
0° - 45°

V 2 x 23 ft

72 ft double swing away jib, can technically be carried on crane

Double fléchette pliante de 72 ft avec maintien à demeure sur la grue

380 ft

360

340

320

300

280

260

240

220

200

180

160

140

120

100

80

60

40

20

0

TNZF TS

NZF 26 ft - 164 ft
0° - 45°

S 13 ft - 151 ft
0°

Fixed jib contains strong jib

Fléchette fixe avec fléchette robuste

TS

S 13 ft - 151 ft
0°

Strong system for steep working positions

Système le plus performant pour les positions de travail les plus raides

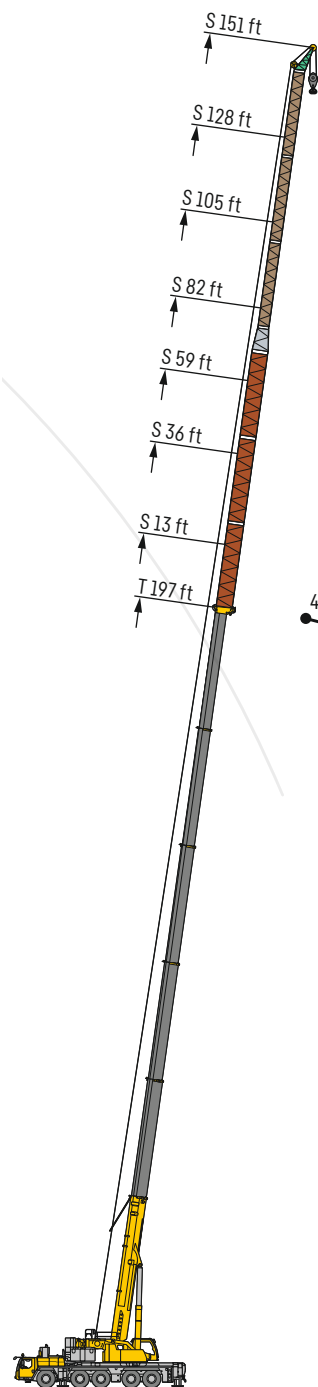

23 ft Telescopic boom extension · Rallonge flèche télescopique



23 ft Swing away jib extension · Rallonge flechette pliante

US2993.01

Boom/jib combinations

Configurations de flèche



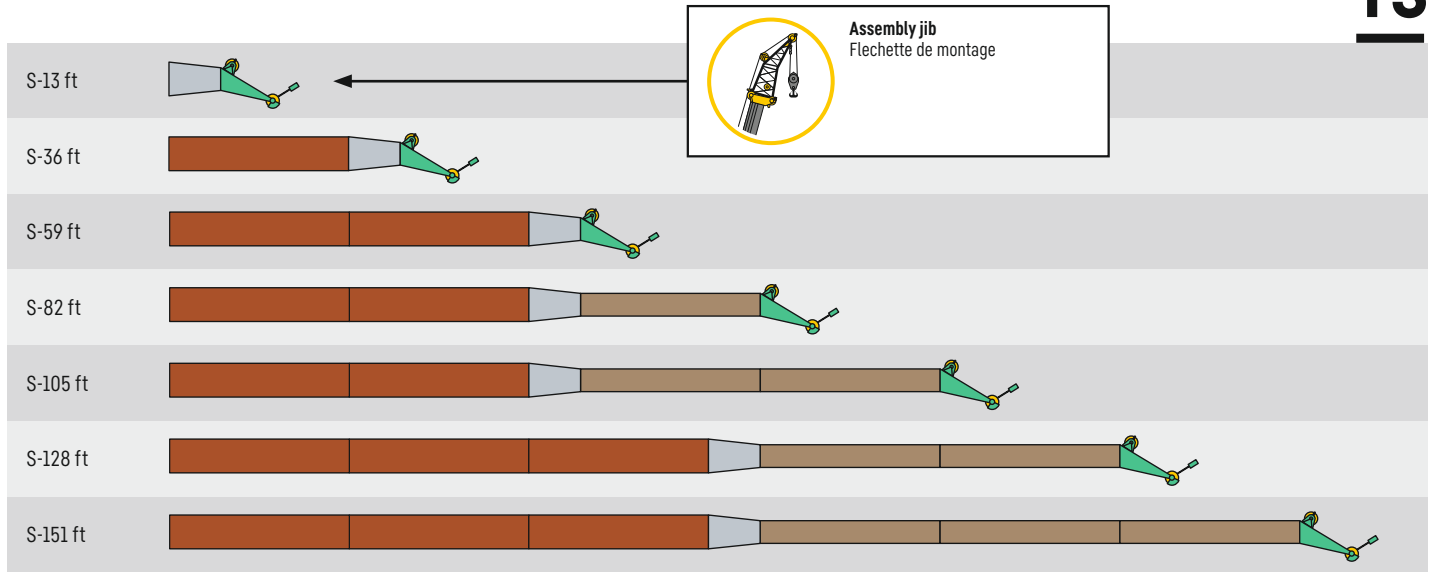

TS

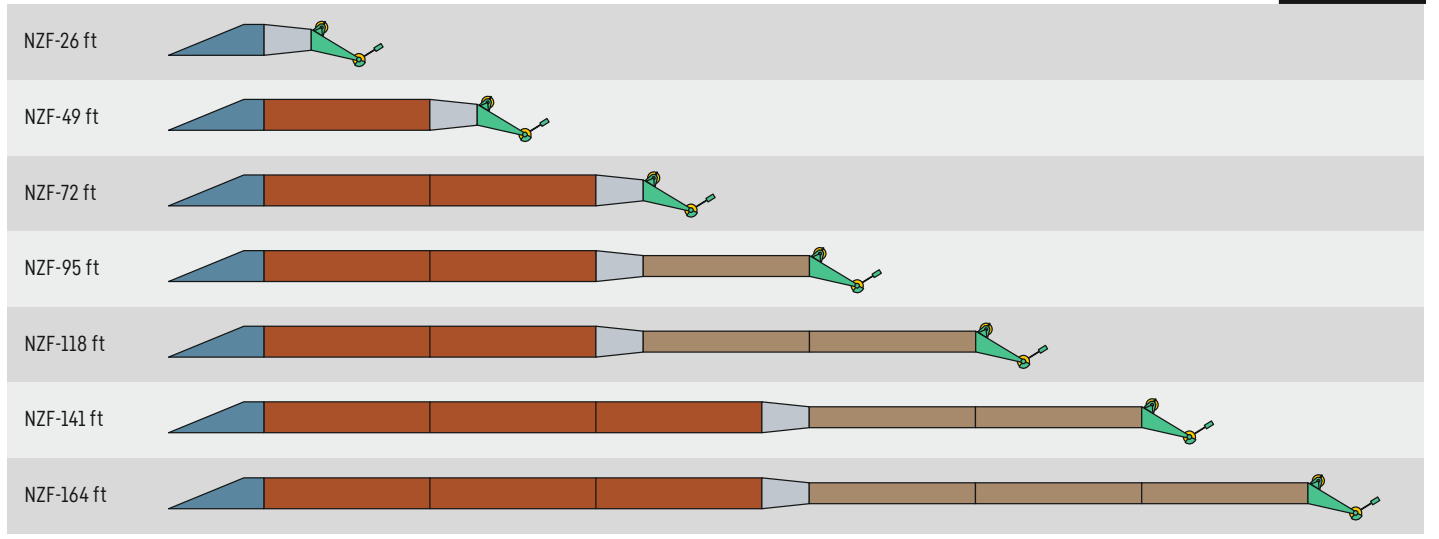

S2992.01

TNZF



-  **13 ft TF-adapter** · TF-adaptateur
-  **23 ft Telescopic boom extension** · Rallonge flèche télescopique
-  **6 ft 7 in F reduction section** · Élément réducteur F
-  **23 ft Swing away jib extension** · Rallonge flechette pliante
-  **6 ft 7 in F head section** · Élément de tête F

US2991.01

Boom/jib combinations

Configurations de flèche

T Telescopic boom - Flèche télescopique

K/NZK Mechanically/hydraulically adjustable folding jib - Pointe pliante réglable mécaniquement/hydrauliquement

V Telescopic boom extension - Rallonge de flèche télescopique

S Strong jib - Fléchette particulièrement puissante

NZF Hydraulically adjustable fixed lattice jib - Fléchette treillis fixe réglable hydrauliquement



S2981.01

Lifting heights

Hauteurs de levage

T

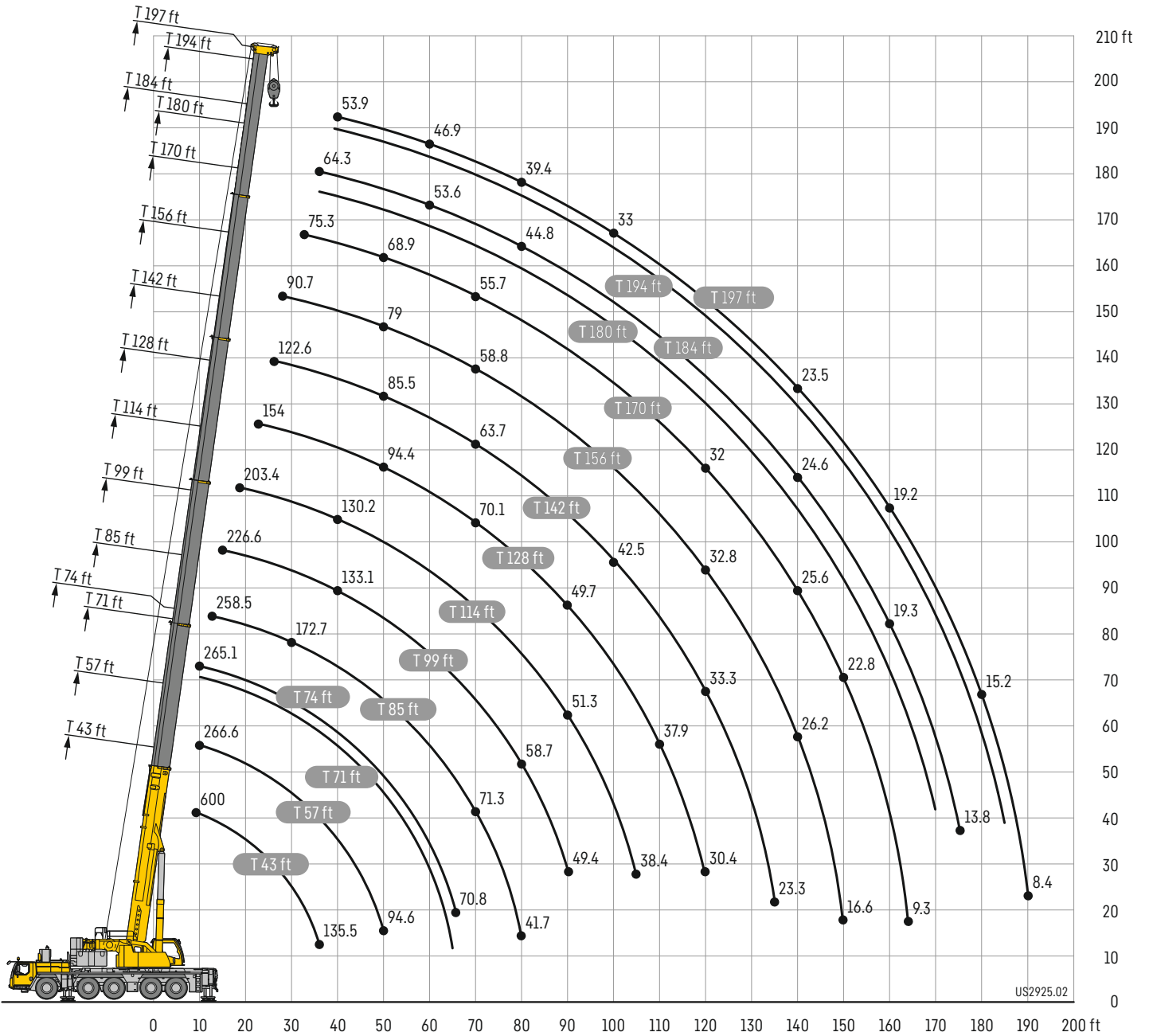

Lifting capacities

Forces de levage

T

43 - 197 ft

360°

194,000 lb

15 ft 8 in

18 ft 4 in

85%

	43 ft	57 ft	71 ft	74 ft	85 ft	99 ft	114 ft	128 ft	142 ft	156 ft	170 ft	180 ft	184 ft	194 ft	197 ft										
9	600															9									
10	551.2	295.4	266.6	265.2	265.1											10									
11	381.9	295.4	267.7	266.1	266											11									
12	312.5	295.4	268.9	267	266.9	258.5										12									
13	309.7	295.4	270.2	268	267.2	260.1										13									
14	306.7	288.8	271.7	269	264.1	261										14									
15	303.7	279.3	273.2	269.5	263.2	262.1	226.6									15									
16	300.3	269	268.1	267.8	261.9	258.9	243.9									16									
17	292.1	259	259.3	258.6	256.2	253	239.8									17									
18	281.7	249.6	249.8	249.7	246.6	243.8	234.6									18									
19	271	240.7	241.1	240.9	237.6	235.1	226.9	203.4								19									
20	261.1	232.3	233.6	232.6	229.3	227.3	220.8	202.6								20									
22	242.9	216.9	218.4	218.5	213.9	216.3	210.3	197.7	154							22									
24	226.6	203.1	204.5	204.9	199.9	205.2	197.7	188.1	150.7							24									
26	211.7	190.7	192.2	192.5	187.4	193.5	186.6	178.5	146.4	122.6						26									
28	197.7	179.6	181.1	181.4	176.4	182.5	177	170	141.3	120.1	90.7					28									
30	184.1	169.7	171.1	171.4	166.4	172.7	168.4	161.7	135.6	117.5	99.9					30									
32	170.2	160.7	162.1	162.3	157.3	163.8	160.7	154	129.7	114.5	98.4	75.3				32									
34	155	152.3	153.8	154.1	149.4	155.5	153.7	147.2	124.3	111.6	96.6	79.2				34									
36	135.5	135.5	145.9	146.2	142.4	147.6	146.8	140.9	119.4	108.8	94.7	78.2	62.4	64.3		36									
38			138.8	139.7	135.8	140.5	139.8	135.3	115.3	105.6	92.7	77.1	61.7	63.8		38									
40			132.1	133.7	129	133.9	133.1	130.2	111.3	101.9	90.6	76	60.8	63.1	55.2	53.9	40								
45			118.3	119.2	114.2	119.2	118.3	116.9	102.4	93.1	84.7	72.7	58.1	61	53.7	52.4	45								
50			94.6	106.7	101.2	106.7	105.8	104.4	94.4	85.5	79	68.9	55.1	58.6	51.8	50.4	50								
55				95.7	90.2	95.6	94.8	93.2	87.3	78.7	73.3	65.4	52.1	56.1	49.7	48.7	55								
60				86.4	80.9	86.5	85.5	84	81.4	72.6	67.9	62.3	49.2	53.6	47.7	46.9	60								
65				63.9	70.8	78.4	77.4	75.8	75.8	67.8	63.1	59	46.6	51.3	45.6	44.9	65								
70						71.3	70.2	68.6	70.1	63.7	58.8	55.7	44.2	49	43.6	43	70								
75						64.4	64	63.4	63.9	59.9	55.1	52.4	41.9	46.9	41.6	41.2	75								
80						41.7	58.7	59.9	58.5	56.6	52.1	49.3	39.8	44.8	39.8	39.4	80								
85							54.1	55.3	53.8	53.3	49.3	46.6	37.9	42.8	38	37.6	85								
90							49.4	51.3	49.7	49.3	46.6	43.9	36.2	40.9	36.4	36	90								
95								47.6	46.1	45.7	43.9	41.4	34.5	39.1	34.8	34.4	95								
100								44.5	42.9	42.5	41.7	39.2	32.9	37.2	33.4	33	100								
105									38.4	40.2	40.5	39.8	37.1	31.5	35.5	32	105								
110										37.9	38	37.5	35.2	30.1	33.7	30.8	110								
115											35.5	35.1	33.7	28.8	32	29.6	115								
120												30.4	32.8	27.5	30.5	28.4	120								
125													31.3	30.8	30	26.4	125								
130														29.5	29	28.7	130								
135															23.3	27.7	135								
140																26.2	140								
145																	24	145							
150																		16.6	150						
155																			21.5	155					
160																			18.8	160					
165																			9.3	165					
170																				16.6	170				
175																					13.8	175			
180																						16.3	180		
185																							15.3	185	
190																								12	190
																								8.4	190

* ± 0° over rear - en arrière

t_259_101_10003 / 12201 / 32201_00_000

Lifting capacities

Forces de levage

T

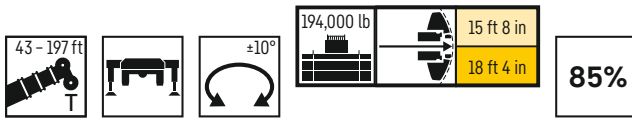

	43 ft	57 ft	71 ft	74 ft	85 ft	99 ft	114 ft	128 ft	142 ft	156 ft	170 ft	180 ft	184 ft	194 ft	197 ft	
10	295.4	266.6	265.2	265.1												10
11	295.4	267.7	266.1	266												11
12	295.4	268.9	267	266.9	258.5											12
13	295.4	270.2	268	267.2	260.1											13
14	295.4	271.7	269	264.1	261											14
15	295.4	273.2	270.1	263.2	262.1	226.6										15
16	295.1	274.3	270.8	262.8	258.9	243.9										16
17	291.2	274.3	262.8	257.8	253	239.8										17
18	281.7	267.2	254.4	248.1	243.8	234.6										18
19	271	259.3	245.6	239.2	235.1	226.9	203.4									19
20	261.1	250.8	237.6	231.1	227.3	220.8	202.6									20
22	242.9	235.1	225.1	216.7	216.3	210.3	197.7	154								22
24	226.6	221	212.8	204.1	205.3	197.7	188.1	150.7								24
26	211.7	207.8	201.2	193.1	194.3	186.6	178.5	146.4	122.6							26
28	197.7	195.9	189.9	182.3	184.6	177	170	141.3	120.1	90.7						28
30	184.1	185	179.7	172.2	176.1	168.4	161.7	135.6	117.5	99.9						30
32	170.2	175.1	170.5	163.1	167.7	160.7	154	129.7	114.5	98.4	75.3					32
34	155	165.6	162.2	154.8	159.7	154	147.2	124.3	111.6	96.6	79.2					34
36	135.5	155.7	154.4	147.1	152.2	147.5	140.9	119.4	108.8	94.7	78.2	62.4	64.3			36
38		146.6	147	139.8	145.5	141.2	135.3	115.3	105.6	92.7	77.1	61.7	63.8			38
40		138.4	138.8	132.4	139.3	135.1	130.2	111.3	101.9	90.6	76	60.8	63.1	55.2	53.9	40
45		121.4	121.6	117.7	123.3	121.8	117.7	102.4	93.1	84.7	72.7	58.1	61	53.7	52.4	45
50		94.6	109.5	103.9	109.5	108.6	106.7	94.4	85.5	79	68.9	55.1	58.6	51.8	50.4	50
55			98.2	92.6	98.1	97.3	95.7	87.3	78.7	73.3	65.4	52.1	56.1	49.7	48.7	55
60			87	83.3	88.8	87.8	86.3	81.4	72.6	67.9	62.3	49.2	53.6	47.7	46.9	60
65			63.9	70.8	80.8	79.9	78.3	75.8	67.8	63.1	59	46.6	51.3	45.6	44.9	65
70					74	73.1	71.5	71.7	63.7	58.8	55.7	44.2	49	43.6	43	70
75					64.5	67.2	65.6	67.1	59.9	55.1	52.4	41.9	46.9	41.6	41.2	75
80					41.7	62	60.4	61.8	56.6	52.1	49.3	39.8	44.8	39.8	39.4	80
85						57.3	57.1	57.3	53.5	49.3	46.6	37.9	42.8	38	37.6	85
90						49.4	54.5	53.3	50.8	46.6	43.9	36.2	40.9	36.4	36	90
95							51.2	49.6	48.2	43.9	41.4	34.5	39.1	34.8	34.4	95
100							46.8	46.3	45.8	41.7	39.2	32.9	37.2	33.4	33	100
105							38.4	43.1	42.5	39.8	37.1	31.5	35.5	32	31.5	105
110								40.2	39.5	38.1	35.2	30.1	33.7	30.8	30.2	110
115								36.4	37.8	36.4	33.7	28.8	32	29.6	28.9	115
120								30.4	35.8	35	32.2	27.5	30.5	28.4	27.7	120
125									33.6	33.1	30.6	26.4	29.1	27.3	26.5	125
130									29.6	31	29.2	25.3	27.7	26.3	25.5	130
135									23.3	29.2	27.9	24.3	26.4	25.3	24.5	135
140										27.4	26.8	23.4	25.2	24.4	23.5	140
145										24	25.8	22.5	24.1	23.4	22.6	145
150										16.6	24.4	21.7	23.1	22.5	21.8	150
155											22.8	21	21.9	21.5	20.9	155
160											18.8	20.3	20.7	20.6	20.2	160
165											9.3	19.7	19.5	19.6	19.4	165
170												16.6	17.7	18.5	18.3	170
175													13.8	17.5	17.3	175
180														15.7	16.2	180
185														12	13.4	185
190															8.4	190

t_259_101_11201 / 31201_00_000

Lifting capacities

Forces de levage

T

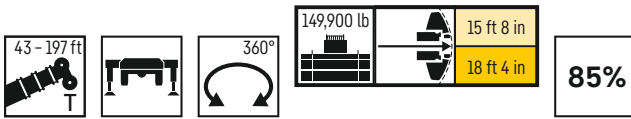

	43ft	57ft	71ft	74ft	85ft	99ft	114ft	128ft	142ft	156ft	170ft	180ft	184ft	194ft	197ft	
10	295.4	266.6	265.2	265.1												10
11	295.4	267.7	266.1	266												11
12	295.4	268.9	267	266.9	258.5											12
13	295.4	270.2	268	267.2	260.1											13
14	287.9	271.7	269	264.1	261											14
15	277.5	272.7	269	263.2	262.1	226.6										15
16	266.4	266	265.2	260.4	258.9	243.9										16
17	256.3	256.6	256.2	253.3	253	239.8										17
18	246.6	246.8	246.7	243.4	243.8	234.6										18
19	237.4	237.8	237.6	234.2	235.1	226.9	203.4									19
20	228.7	230	229.7	225.6	227.2	220.8	202.6									20
22	213.1	214.6	214.7	210.1	214.7	210.3	197.7	154								22
24	199.5	201	201.3	196.3	202.3	197.7	188.1	150.7								24
26	187.1	188.6	188.9	183.6	190.1	186.6	178.5	146.4	122.6							26
28	175.4	177	177.6	172.8	178.6	176.9	170	141.3	120.1	90.7						28
30	164.8	166.4	168.2	163.2	168.2	167.4	161.7	135.6	117.5	99.9						30
32	155	156.7	158.5	153.8	158.7	157.7	154	129.7	114.5	98.4	75.3					32
34	146.2	147.9	149.6	144.6	149.7	148.9	146.5	124.3	111.6	96.6	79.2					34
36	135.5	140.1	141.2	135.7	141.2	140.3	138.3	119.4	108.8	94.7	78.2	62.4	64.3			36
38		131.9	132.9	127.5	133	132.3	130.7	115.3	105.6	92.7	77.1	61.7	63.8			38
40		124.5	125.5	120	125.7	124.8	123.4	111.3	101.9	90.6	76	60.8	63.1	55.2	53.9	40
45		107.8	109	102.9	109.1	108	106.4	102.4	93.1	84.7	72.7	58.1	61	53.7	52.4	45
50		93.4	94.6	91.1	94.6	93.7	92.1	91.8	85.5	79	68.9	55.1	58.6	51.8	50.4	50
55			83.2	79.7	83.1	82.2	81.3	82.2	78.7	73.3	65.4	52.1	56.1	49.7	48.7	55
60			74	70.6	73.9	73	74.5	73	72.1	67.9	62.3	49.2	53.6	47.7	46.9	60
65			63.9	63.1	66.3	65.3	66.8	65.3	64.9	62.8	59	46.6	51.3	45.6	44.9	65
70					60	60.9	60.4	59.5	58.5	57.7	55.7	44.2	49	43.6	43	70
75					54.7	56	55	54.1	53.5	53.5	52	41.9	46.9	41.6	41.2	75
80					41.7	51.3	50.3	49.4	49.6	49.3	47.8	39.8	44.8	39.8	39.4	80
85						47.3	46.3	45.5	45.7	45.1	43.9	37.9	42.8	38	37.6	85
90						43.8	42.6	43.2	42.2	41.4	40.7	36.2	40.1	36.4	36	90
95							39.4	40	39	38.6	38.1	34.5	37.2	34.8	34.4	95
100							36.5	37.1	36	35.7	35.2	32.9	34.3	33.4	33	100
105							34.7	34.5	33.4	33.3	32.6	31.5	31.7	31.6	31.3	105
110								32.1	31.6	31.1	30.2	30	29.3	29.5	29.3	110
115								30.1	29.8	29	28.1	28.4	27.1	27.3	27.1	115
120								28.2	27.9	27.1	26.1	26.4	25.2	25.4	25.2	120
125									26.1	25.3	24.4	24.7	23.4	23.6	23.4	125
130									24.6	23.7	22.7	23	21.8	21.9	21.8	130
135									23.1	22.2	21.2	21.5	20.3	20.5	20.3	135
140										20.9	19.9	20.1	18.9	19.1	18.9	140
145										19.7	18.6	18.9	17.6	17.8	17.6	145
150										16.6	17.5	17.7	16.4	16.6	16.4	150
155											16.4	16.6	15.4	15.5	15.3	155
160											15.5	15.6	14.3	14.5	14.3	160
165											9.3	14.7	13.4	13.5	13.3	165
170												13.8	12.5	12.6	12.4	170
175													11.7	11.8	11.6	175
180														11	10.9	180
185														10.3	10.1	185
190															8.4	190

t_259_101_12004 / 32004_00_000

Lifting capacities

Forces de levage

T

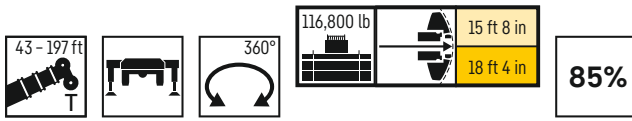

	43 ft	57 ft	71 ft	74 ft	85 ft	99 ft	114 ft	128 ft	142 ft	156 ft	170 ft	180 ft	184 ft	194 ft	197 ft	
10	295.4	266.6	265.2	265.1												10
11	295.4	267.7	266.1	266												11
12	295.4	268.9	267	266.9	258.5											12
13	294.9	270.2	268	267.2	260.1											13
14	285.5	271.7	269	264.1	261											14
15	273.5	270.1	268.1	263.2	262.1	226.6										15
16	262.1	261.7	262.2	257.8	258	243.9						243.9				16
17	251.7	252	251.9	248.7	250.9	239.8										17
18	242	242.2	242.2	238.9	241.6	234.6										18
19	233	233.5	233.2	229.8	233	226.9	203.4									19
20	224.5	225.8	226	221.4	225.4	220.8	202.6									20
22	208.5	210.2	210.3	205.3	211	210.2	197.7	154								22
24	194	195.6	196.4	192.7	197.1	196.4	188.1	150.7								24
26	180.6	182.3	184.1	179.2	183.9	183.1	176.2	146.4	122.6							26
28	168.1	169.8	171.8	166.5	171.9	170.9	164.2	141.3	120.1	90.7						28
30	155.6	158	159.8	154.3	159.9	158.9	153	135.6	117.5	99.9						30
32	144.6	147.7	148.8	143.1	149	148	142.8	129.7	114.5	98.4	75.3					32
34	134.2	137.5	138.7	132.5	138.7	137.8	133.6	124.3	111.6	96.6	79.2					34
36	123.7	127.3	128.7	122.3	128.8	127.8	124.4	119.4	108.8	94.7	78.2	62.4	64.3			36
38		117.9	119.2	115.2	119.4	118.6	116.1	112.2	105.6	92.7	77.1	61.7	63.8			38
40		109.6	110.9	107.3	111.1	110.2	108.4	105.2	101.9	90.6	76	60.8	63.1	55.2	53.9	40
45		92.8	94.1	90.5	94.2	93.2	93.3	92.7	89.3	84.3	72.7	58.1	61	53.7	52.4	45
50		80.2	81.4	77.9	81.4	80.6	82.2	80.8	78.4	74.7	68.9	55.1	58.6	51.8	50.4	50
55			71.3	68.6	71.3	72.9	71.9	71.1	69.4	66.9	64.8	52.1	56.1	49.7	48.7	55
60			63.3	62.1	63.2	64.8	63.8	63	62.8	61.5	58.5	49.2	53.6	47.7	46.9	60
65			56.8	55.6	57.1	58.1	57.1	57.1	56.8	55.5	52.8	46.6	50.5	45.6	44.9	65
70					52.7	52.4	51.4	52.1	51.1	50.2	49	44.2	46.6	43.6	43	70
75					47.8	47.5	46.6	47.2	46.2	45.9	44.7	41.9	42.3	41	40.6	75
80					41.7	43.3	43.7	42.9	42.5	42	40.9	39.7	38.6	37.9	37.5	80
85						39.6	40	39.2	39	38.3	37.4	37.1	35.3	34.8	34.3	85
90						36.5	36.8	36	35.8	35	34	34.1	32.4	31.9	31.5	90
95							34	33.4	32.9	32.2	31.1	31.3	29.8	29.4	29	95
100							31.5	31	30.4	29.6	28.5	28.7	27.3	27.1	26.7	100
105							29.3	28.7	28.1	27.3	26.1	26.3	24.9	24.9	24.6	105
110								26.7	26.1	25.2	24	24.2	22.8	22.8	22.6	110
115								24.9	24.2	23.3	22.1	22.3	20.9	21	20.7	115
120								23.3	22.5	21.6	20.4	20.6	19.2	19.2	19	120
125									21	20	18.8	19	17.6	17.7	17.5	125
130									19.7	18.6	17.4	17.6	16.2	16.3	16	130
135									18.5	17.3	16.1	16.3	14.9	15	14.7	135
140										16.2	14.9	15.1	13.7	13.8	13.5	140
145										15.1	13.9	14	12.6	12.7	12.4	145
150										14.1	12.9	13	11.6	11.6	11.4	150
155											12	12	10.7	10.7	10.5	155
160											11.2	11.2	9.8	9.8	9.6	160
165											9.3	10.4	9	9	8.8	165
170												9.7	8.3	8.3	8.1	170
175													7.6	7.6	7.4	175
180														7.1	6.9	180
185														6.5	6.2	185
190															5.7	190

t_259_101_12007 / 32007_00_000

Lifting capacities

Forces de levage

T

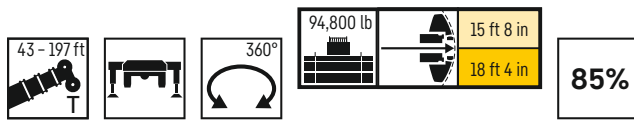

	43 ft	57 ft	71 ft	74 ft	85 ft	99 ft	114 ft	128 ft	142 ft	156 ft	170 ft	180 ft	184 ft	194 ft	197 ft	
10	295.4	266.6	265.2	265.1												10
11	295.4	267.7	266.1	266												11
12	295.4	268.9	267	266.9	258.5											12
13	292.8	270.2	268	267.2	260.1											13
14	281.8	271.7	269	264.1	261											14
15	269.7	267.7	267.4	262.8	262.1	226.6										15
16	258.4	258.8	258.6	255.6	256	243.9										16
17	248.2	248.5	248.4	245.2	248.2	239.4										17
18	238.5	238.9	238.8	235.4	238.5	233.6										18
19	229	229.5	229.4	225.6	229.1	224.6	203.4									19
20	219.9	221.3	221.6	217.3	221	216.6	202.6									20
22	202.8	204.6	206.1	201.6	206.1	202.9	192.8	154								22
24	186.9	188.9	190.6	185.5	190.8	186.7	177.3	150.7								24
26	171.1	173.3	175.5	169.7	175.3	171.7	160.7	145.8	122.6							26
28	156.7	160.1	161.4	155.3	161.3	156.2	146.2	138	120.1	90.7						28
30	142.4	146.3	147.9	140.9	147.7	142.9	134.4	128.1	117.5	99.9						30
32	129.1	133	134.4	130.1	134.9	131.4	124.7	119	112.6	98.4	75.3					32
34	117.8	121.6	123	119.3	123.3	121.6	115.5	112.2	106.2	96.6	79.2					34
36	108.2	111.8	113.2	109.6	113.3	112.3	108.2	104.5	100.3	94.2	78.2	62.4	64.3			36
38		103.4	104.7	101.1	104.9	104.1	103.7	98.7	93.9	89.3	77.1	61.7	63.8			38
40		96	97.4	93.8	97.6	96.6	97.4	92.7	88.1	83.8	76	60.8	63.1	55.2	53.9	40
45		81.1	82.4	81	82.5	84.1	83.1	80.2	76.8	74.6	70.4	58.1	61	53.7	52.4	45
50		69.9	71.1	69.9	72.2	72.8	71.8	70.4	68.7	65.9	62	55.1	58.4	51.8	50.4	50
55			62	60.8	63.8	63.7	62.6	63.5	61.1	58.7	55.8	52.1	52.5	49.7	48.7	55
60			55.2	53.4	56.4	56.2	56.2	56	54.8	52.7	49.7	48.5	46.6	45.4	44.9	60
65			49.2	47.4	50.3	50	50.6	49.7	49.2	47	44.3	43.6	41.7	40.6	40.1	65
70					45.2	44.9	45.4	44.7	43.7	42.3	39.8	39.2	37.3	36.5	36.1	70
75					40.8	41	40.8	40.1	39.1	38	35.9	35.5	33.6	33	32.5	75
80					37	36.9	36.8	36	35.2	34.1	32.5	32.2	30.4	29.8	29.4	80
85						33.5	33.4	32.7	31.8	30.7	29.5	29.3	27.5	27	26.6	85
90						30.6	30.5	29.7	28.8	27.8	26.6	26.7	25	24.6	24.2	90
95							27.8	27.1	26.3	25.3	24	24.2	22.7	22.4	22.1	95
100							25.6	24.9	24	23	21.8	22	20.6	20.5	20.2	100
105							23.6	22.9	22	21	19.8	20	18.6	18.6	18.3	105
110								21.1	20.2	19.2	18	18.2	16.8	16.8	16.6	110
115								19.5	18.6	17.6	16.4	16.6	15.2	15.2	15	115
120								18.1	17.1	16.1	14.9	15.1	13.7	13.8	13.5	120
125									15.9	14.8	13.6	13.8	12.4	12.4	12.2	125
130									14.7	13.6	12.4	12.6	11.2	11.2	11	130
135									13.7	12.5	11.3	11.4	10.1	10.1	9.9	135
140										11.5	10.3	10.4	9.1	9.1	8.9	140
145										10.7	9.4	9.5	8.2	8.2	8	145
150										10	8.6	8.7	7.4	7.4	7.2	150
155											7.8	7.9	6.7	6.7	6.6	155
160											7.2	7.2	6	6.1	5.9	160
165											6.7	6.7	5.3	5.5	5.3	165
170												6.1	4.7	4.8	4.6	170
175													4.1	4.2	4	175
180														3.6	3.4	180
185														3.1	2.9	185
190															2.5	190

t_259_101_12010 / 32010_00_000

Lifting capacities

Forces de levage

T

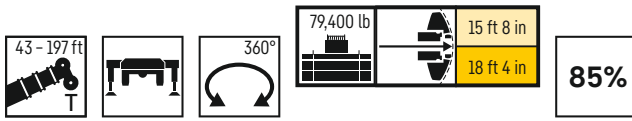

	43ft	57ft	71ft	74ft	85ft	99ft	114ft	128ft	142ft	156ft	170ft	180ft	184ft	194ft	197ft	
10	295.4	266.6	265.2	265.1												10
11	295.4	267.7	266.1	266												11
12	295.4	268.9	267	266.9	258.5											12
13	290.9	270.2	268	267.2	260.1											13
14	278.9	271.7	268.4	264.1	261											14
15	266.9	266	265.7	260.7	262.1	226.6										15
16	255.7	256.1	255.9	252.9	254.3	243.9										16
17	245.3	245.7	245.7	242.3	245.4	237										17
18	235.2	235.4	235.5	231.8	235.2	229.1										18
19	225.4	226.9	226.5	224	225.6	219.5	202.5									19
20	216	217.5	217.9	214.6	217.3	211.4	199.8									20
22	198.2	200.1	201.9	196.7	202.1	194.5	181.4	154								22
24	180.3	182.4	184.8	178.8	184.5	174.5	162.1	148.3								24
26	163.9	167.5	168.8	162.3	167.4	156.8	146.8	139.1	122.5							26
28	147.5	151.4	153.3	146.9	151.4	142.3	134.3	126.8	119.2	90.7						28
30	132.4	136.2	138	134.1	137.9	130.1	123	119	111.8	99.9						30
32	119.9	123.8	125.2	121.5	125.7	119.5	116.3	110.9	105.1	97.2	75.3					32
34	109.3	113.1	114.5	110.9	114.8	110.7	108.3	102.9	97.5	92.3	79.2					34
36	100.3	103.9	105.3	101.7	105.4	102.4	100.8	95.8	90.9	86.1	78.2	62.4	64.3			36
38		96.1	97.4	93.8	97.6	97.8	94.2	89.6	84.9	81.9	76.2	61.7	63.8			38
40		89.1	90.5	88.7	90.7	92.5	88.4	84.3	81.3	78.4	74.2	60.8	63.1	55.2	53.9	40
45		75.1	76.5	75.2	78	78.2	75.8	73.7	70.9	68.3	64.7	58.1	60	53.7	52.4	45
50		64.3	66	64.3	67.5	67.4	66.1	65	62.3	60.1	56.6	54.6	53	51	50.2	50
55			57.5	55.7	58.8	58.7	59.2	57.1	55.4	52.9	49.6	48.6	46.4	45.2	44.6	55
60			50.4	49.2	51.8	51.5	51.7	50.8	49.2	46.8	43.9	43	41	40	39.4	60
65			44.2	44.5	45.6	45.8	45.4	44.7	43.6	41.6	39	38.4	36.5	35.5	35.1	65
70					40.4	40.7	40.4	39.6	38.6	37.3	34.9	34.4	32.6	31.8	31.4	70
75					36.1	36.3	36.1	35.4	34.4	33.3	31.3	31	29.2	28.6	28.2	75
80					32.7	32.7	32.5	31.7	30.8	29.8	28.2	28	26.2	25.7	25.3	80
85						29.5	29.3	28.6	27.7	26.7	25.4	25.3	23.6	23.2	22.8	85
90						26.8	26.7	25.9	25.1	24	22.8	22.9	21.3	20.9	20.6	90
95							24.3	23.6	22.7	21.7	20.5	20.7	19.2	19	18.6	95
100							22.3	21.5	20.6	19.6	18.4	18.6	17.2	17.2	16.9	100
105							20.5	19.6	18.8	17.8	16.6	16.8	15.4	15.4	15.2	105
110								18	17.2	16.1	15	15.2	13.8	13.8	13.6	110
115								16.6	15.7	14.7	13.5	13.7	12.3	12.4	12.1	115
120								15.4	14.4	13.4	12.2	12.4	11	11	10.8	120
125									13.2	12.2	11	11.2	9.8	9.8	9.6	125
130									12.2	11.1	9.9	10.1	8.7	8.8	8.5	130
135									11.4	10.1	8.9	9.1	7.7	7.8	7.6	135
140										9.2	8	8.1	6.9	7	6.8	140
145										8.4	7.3	7.4	6.2	6.2	6.1	145
150										7.8	6.6	6.7	5.5	5.6	5.4	150
155											6	6.1	4.8	4.9	4.7	155
160											5.3	5.4	4.1	4.2	4	160
165											4.8	4.8	3.4	3.6	3.4	165
170												4.2	2.9	3	2.8	170
175													2.3	2.4	2.2	175

t_259_101.12013 / 32013.00.000

Lifting capacities

Forces de levage

T

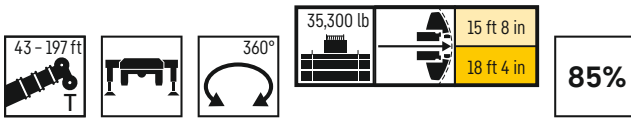

	43 ft	57 ft	71 ft	74 ft	85 ft	99 ft	114 ft	128 ft	142 ft	156 ft	170 ft	180 ft	184 ft	194 ft	197 ft	
10	295.4	266.6	265.2	265.1												10
11	295.4	267.7	266.1	266												11
12	294.8	268.9	267	266.9	258.5											12
13	285.6	270.2	268	267.2	260.1											13
14	272.1	268	265.7	264.1	257											14
15	258.8	258.8	259.1	256	249	220.9										15
16	246	246.6	246.1	238.9	226.7	209.4										16
17	233.3	234	227.7	217.9	208	194										17
18	220	221.8	210.6	197.8	195.5	178.3										18
19	206.8	207.4	196.6	186.1	180.7	165.4	152.2									19
20	193.7	195.1	181.3	171.7	167.6	153.9	143.9									20
22	166.6	167	156.4	148	145.7	136.4	129.2	120.3								22
24	143.3	145.4	137.8	131	128.6	123.8	115.1	107.9								24
26	125.1	128.2	122.1	118.4	117	110.6	102.9	98.7	92.5							26
28	110.5	114	108.9	105.6	105.5	99.4	94.8	89.9	84.5	78.7						28
30	98.6	101.6	98.5	94.7	95.3	90	86.4	81.9	77.3	72.9						30
32	88.5	91.5	89	85.5	86.6	82.8	79	75	70.9	66.9	62.7					32
34	78.2	82.9	81	78	79.1	76.2	72.6	69	65.4	61.6	57.7					34
36	69.5	74.5	74.2	73.5	72.6	69.9	67	63.8	60.4	57.1	53.5	52.5	49.9			36
38		67.2	68.2	68.2	67.1	64.8	62.2	59.2	56.1	53	49.7	48.8	46.2			38
40		60.8	62.9	62.9	62.2	60.2	57.9	55.1	52.2	49.4	46.2	45.3	42.8	41.2	40.5	40
45		48.5	50.8	51.1	51.9	50.6	48.8	46.7	44.1	41.7	39	38.2	36	34.7	34.1	45
50		39.6	42	42.3	43.1	43.1	41.9	39.9	37.9	35.7	33.2	32.5	30.4	29.4	28.9	50
55			35.1	35.5	36.4	36.5	36	34.6	32.8	30.9	28.5	27.9	26	25.2	24.7	55
60			29.8	30.2	31.1	31.2	30.9	30.1	28.5	26.8	24.7	24.1	22.3	21.6	21.2	60
65			25.7	25.9	26.9	26.9	26.6	25.9	24.9	23.4	21.3	21	19.2	18.6	18.2	65
70					23.4	23.4	23.2	22.5	21.6	20.4	18.5	18.3	16.6	16.1	15.8	70
75					20.6	20.5	20.3	19.6	18.7	17.7	16.1	16	14.3	13.9	13.6	75
80					18.3	18.1	17.8	17.1	16.3	15.3	14	13.9	12.2	12	11.6	80
85						16	15.7	15	14.2	13.2	11.9	12.1	10.5	10.3	9.9	85
90						14.2	13.9	13.2	12.4	11.4	10.1	10.4	8.9	8.7	8.4	90
95							12.3	11.6	10.8	9.8	8.6	8.8	7.5	7.4	7.1	95
100							11	10.2	9.4	8.4	7.3	7.5	6.2	6.2	5.9	100
105							9.8	9	8.2	7.3	6.3	6.4	5.1	5.1	4.8	105
110								7.9	7.2	6.3	5.3	5.5	4	4.1	3.7	110
115								7.1	6.3	5.5	4.5	4.7	2.8	2.9	2.5	115
120								6.4	5.6	4.7	3.7	3.9				120
125									4.8	3.9	2.6	3				125
130									4.1	3.1						130
135									3.5	2.2						135

t_259_101_12018 / 32018_00_000

Lifting capacities

Forces de levage

T

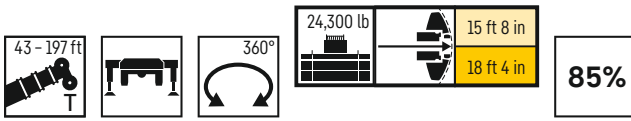

	43ft	57ft	71ft	74ft	85ft	99ft	114ft	128ft	142ft	156ft	170ft	180ft	184ft	194ft	197ft	
10	295.4	266.6	265.2	265.1												10
11	295.4	267.7	266.1	266												11
12	294.7	268.9	267	266.9	258.5											12
13	284.9	270.2	268	267.2	260.1											13
14	270.8	267.3	264.8	264.1	251.2											14
15	257.2	257.5	254.6	243.3	227.8	203.9										15
16	244	244.1	229.3	219.7	207.8	192.1										16
17	228.9	229.1	212.1	201.2	195.1	176.7										17
18	214.4	210.5	195.6	184.9	178.3	163.8										18
19	199.9	194.3	179.3	169	164.7	152	142.6									19
20	184.9	177.7	165.2	155.9	152.6	143.3	133.3									20
22	155.6	151.8	142.3	137.3	132.8	126.6	116.5	108.4								22
24	133.6	131.8	124.7	120.8	119.3	111.3	104.2	98.1								24
26	116.5	115.2	109.4	105.6	105.3	98.7	94.1	88.5	82.8							26
28	102.8	101.2	97.8	93.6	94	89.4	84.7	79.9	75.1	69.7						28
30	90.2	89.9	87.5	85.4	84.8	80.8	76.8	72.6	68.4	64.3						30
32	78.2	80.8	78.9	78.8	76.9	73.6	70.1	66.4	62.6	58.9	54.9					32
34	68.5	73.1	71.6	71.6	70.1	67.5	64.3	60.9	57.6	54.1	50.5					34
36	60.6	65.6	65.4	65.4	64.2	61.9	59.2	56.2	53.1	50	46.7	45.8	43.3			36
38		59	60.1	60.1	59.2	57.2	54.8	52.1	49.2	46.4	43.2	42.5	40			38
40		53.3	55.4	55.4	54.8	53	51	48.4	45.7	43	40	39.3	37	35.5	34.8	40
45		42.2	44.4	44.7	45.5	44.3	42.7	40.8	38.4	36.1	33.5	32.9	30.7	29.6	29	45
50		34.2	36.5	36.8	37.6	37.6	36.5	34.7	32.8	30.6	28.3	27.8	25.8	24.9	24.4	50
55			30.4	30.7	31.5	31.6	31.2	29.8	28.1	26.3	24.1	23.6	21.7	21	20.6	55
60			25.6	25.9	26.8	26.9	26.6	25.8	24.3	22.6	20.6	20.2	18.4	17.8	17.4	60
65			21.8	22.1	23	23	22.7	22.1	21	19.5	17.6	17.4	15.6	15.1	14.8	65
70					19.9	19.9	19.6	18.9	18	16.9	15.1	15	13.2	12.9	12.5	70
75					17.3	17.2	17	16.3	15.5	14.4	12.9	12.9	11.2	10.9	10.5	75
80					15.3	15	14.8	14.1	13.3	12.3	10.9	11	9.3	9.1	8.8	80
85						13.1	12.9	12.2	11.4	10.4	9.1	9.3	7.7	7.6	7.2	85
90						11.6	11.2	10.5	9.7	8.7	7.6	7.8	6.3	6.2	5.9	90
95							9.8	9.1	8.3	7.4	6.4	6.5	5	5	4.7	95
100							8.6	7.9	7.1	6.3	5.3	5.5	3.6	3.7	3.3	100
105							7.6	6.9	6.2	5.4	4.2	4.4	2.3	2.3		105
110								6.1	5.4	4.5	3	3.4				110
115								5.3	4.6	3.7						115
120								4.6	3.8	2.6						120
125									3.1							125
130									2.3							130

t_259_101_12019 / 32019_00_000

Lifting capacities

Forces de levage

T

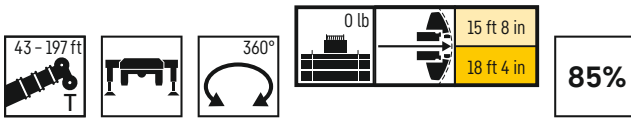

	43 ft	57 ft	71 ft	74 ft	85 ft	99 ft	114 ft	128 ft	142 ft	156 ft	170 ft	180 ft	184 ft	194 ft	197 ft	
10	295.4	266.6	265.2	265.1												10
11	295.4	267.7	266.1	266												11
12	293.7	268.9	267	258.1	240.4											12
13	277.9	268.4	244	236.8	222											13
14	261.2	247.6	217.9	210.2	198.2											14
15	241.4	217.3	198.4	185.9	176	148										15
16	217.2	196.3	176.4	167	159	146										16
17	191	174.7	159	153.4	146	132.7										17
18	169.8	157	143.2	137.8	132.6	120.3										18
19	151.5	141.7	130	123.9	120.9	110.9	102.1									19
20	135.3	126.9	118.5	113.1	110.6	102.3	94.4									20
22	109.3	105.1	99.3	98.6	93.9	87.8	81.7	74.9								22
24	91	88.9	85.5	84.6	81.2	76.5	71.6	66.7								24
26	77.2	76.4	74.1	73.6	71.2	67.3	63.4	59.2	54.8							26
28	66.4	66.5	65.1	64.9	63	59.9	56.6	53	49.2	44.9						28
30	57.8	58.4	57.7	57.7	56.4	53.8	50.9	47.8	44.5	41.2						30
32	49.4	52	51.5	51.6	50.8	48.5	46.1	43.3	40.3	37.3	34.1					32
34	42.6	46.4	46.3	46.5	45.9	44.2	41.9	39.4	36.7	33.9	30.9					34
36	37	41.7	41.9	42.1	41.6	40.1	38.3	36	33.5	31	28.2	27.7	25.5			36
38		37.2	38.1	38.2	38	36.8	35.1	33	30.7	28.4	25.7	25.4	23.2			38
40		33.1	34.7	34.9	34.9	33.8	32.3	30.3	28.2	26	23.4	23.2	21	20.2	19.6	40
45		25.3	27.4	27.7	28.4	27.5	26.4	24.9	22.9	21	18.8	18.7	16.6	16	15.6	45
50		19.7	21.7	22	23	22.8	21.9	20.5	18.9	17.1	15	15.1	13.1	12.7	12.2	50
55			17.4	17.7	18.6	18.7	18.2	17	15.5	14	12	12.1	10.2	9.9	9.6	55
60			14.1	14.3	15.2	15.3	15.1	14.2	12.8	11.3	9.5	9.6	7.8	7.7	7.3	60
65			11.5	11.7	12.5	12.6	12.3	11.7	10.4	9.1	7.4	7.6	5.6	5.7	5.2	65
70					10.3	10.3	10.1	9.5	8.5	7.2	5.4	5.7	3.5	3.4	3.1	70
75					8.5	8.5	8.2	7.6	6.9	5.6	3.5	3.8				75
80					7.3	7	6.8	6.3	5.4	3.8						80
85						5.9	5.7	5.1	3.9	2.3						85
90						4.8	4.7	3.9	2.4							90
95							3.5	2.6								95
100							2.4									100

t_259_101_12021 / 32021_00_000

Lifting heights

Hauteurs de levage

TNZK

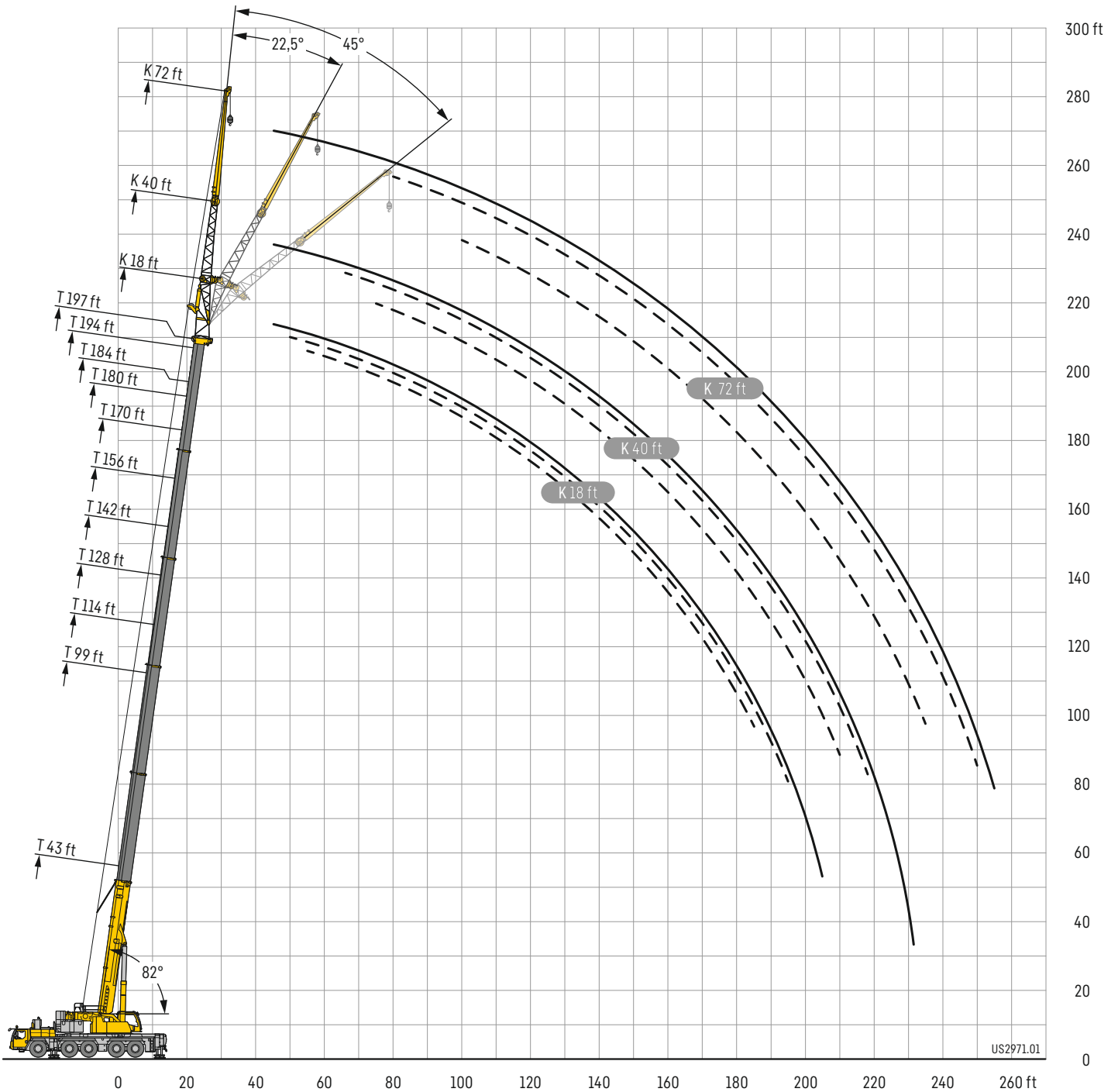

Lifting capacities

Forces de levage

TNZK

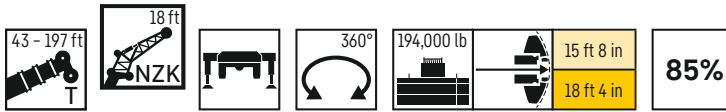

	43 ft			99 ft			114 ft			128 ft			142 ft			156 ft			
	0°	22,5°	45°	0°	22,5°	45°	0°	22,5°	45°	0°	22,5°	45°	0°	22,5°	45°	0°	22,5°	45°	
10	127.9																		10
11	127.9																		11
12	127.9	96.2																	12
13	127.2	93.4																	13
14	123.9	91.4																	14
15	120.6	89.8																	15
16	117.3	88.1	75																16
17	114	86.4	74.7																17
18	111.2	84.7	73.6	118.4															18
19	108.4	82.9	72.4	117.1															19
20	105.5	81.2	71.2	115.9			111.4												20
22	98.9	78.2	69.1	113.3	88.7		109.9												22
24	94.4	75.9	67.3	110.9	87.2		108.1			99.3									24
26	90.8	73.4	66	108.5	85.7	73.3	106.3	85.8		98.6									26
28	86	70.9	64.6	106.1	84.3	72.4	104.5	84.5		97.4			86.7						28
30	82.4	68.8	63.4	103.9	82.9	71.5	102.7	83.3	72.2	96.2	81.2		86.3						30
32	79	67	61.9	101.8	81.5	70.8	101	82.1	71.5	95.1	80.3	70.8	85.8						32
34	76.4	65.3	60.5	99.8	80.2	70.1	99.4	80.9	70.8	93.9	79.3	70.2	85.2	75.9					34
36	74.1	63.4	59.1	97.9	79	69.4	97.8	79.9	70.1	92.8	78.4	69.6	84.6	75.2					36
38	71.1	61.1	57.7	95.9	77.9	68.7	96.1	78.8	69.4	91.7	77.4	69	83.9	74.5	68.1				38
40	68	58.8	56.2	94	76.7	67.9	94.4	77.7	68.8	90.4	76.5	68.4	83.2	73.8	67.6				40
45	60.4	53.9	53.5	89.4	74	66.2	90.4	75.2	67.4	87.3	74.2	67.1	80.9	72	66.4	69.7	67.2	63.3	45
50	54.1	50.9	13.1	85.2	71.6	64.6	86.7	72.9	66.1	82.6	72.1	65.9	75.9	70.2	65.2	66.5	65.2	62.4	50
55	46.1			81.7	69.5	63.1	83.3	70.8	64.6	76.4	70.3	64.8	70.8	68.6	64.2	63	61.8	60.9	55
60				78.1	67.2	61.4	80.3	69	63.4	70.5	68.1	63.6	65.7	65.4	63.2	59.5	58.4	57.9	60
65				74.6	65.2	59.7	75.8	67.4	61.9	65.2	64.5	62.2	61	61.1	60.5	56.1	55.4	54.9	65
70				70.1	62.9	58.1	68.7	65.8	60.4	60.6	60.5	60.1	56.7	56.9	57	52.8	52.5	52.1	70
75				63.8	60	56.5	62.4	63.1	59	56.1	56.4	56.7	52.9	53	53.4	49.5	49.7	49.6	75
80				58.4	57.5	55.2	57	57.6	57.4	52.5	52.6	52.8	49.4	49.6	49.9	46.4	46.7	46.9	80
85				53.7	54.1	54	52.3	52.8	53.1	49	49.2	49.5	46.2	46.5	46.8	43.7	43.9	44.2	85
90				49.6	50	39.8	48.2	48.7	48.9	46	46	46.3	43.4	43.6	43.9	41	41.4	41.7	90
95				46	46.3	19.7	44.6	44.9	45.1	43.1	43.3	43.5	40.7	41	41.2	38.5	38.9	39.2	95
100				42.8	43	12.6	41.3	41.6	41.7	39.7	40.2	40.4	38.7	38.5	38.7	36.4	36.6	36.9	100
105				39.7	40		38.3	38.6	23	36.7	37.1	37.2	36.8	36.6	36.6	34.3	34.6	34.8	105
110				30.1			35.6	35.8	14.9	34	34.3	34.4	34.8	34.9	35	32.4	32.6	32.8	110
115							33.1	33.3		31.5	31.8	26.3	32.5	32.8	33	30.6	30.9	31	115
120							30.1			29.3	29.5	17.4	30.2	30.5	30.6	28.8	29.1	29.3	120
125							20.2			27.3	27.5	12.6	28.2	28.5	28.5	27.5	27.4	27.6	125
130										25.4	25.6		26.3	26.5	19.7	26.4	26.3	26.5	130
135										21.9			24.6	24.8	14.1	24.9	25.1	25.2	135
140										14.8			23	23.2		23.3	23.5	22	140
145													21.6			21.8	22	16.1	145
150													18.9			20.5	20.6	12.5	150
155																19.2	19.4		155
160																17.9			160
165																15.2			165

	170 ft			180 ft			184 ft			194 ft			197 ft				
	0°	22,5°	45°	0°	22,5°	45°	0°	22,5°	45°	0°	22,5°	45°	0°	22,5°	45°		
36	60.7															36	
38	60.3			47.6												38	
40	59.6			47.3			49.5									40	
45	57.7	56.7		46.1	45.2		48.2			40.9						45	
50	55.6	54.5	54.1	44.8	43.7	43.4	46.7	46.2	45.7	40.2	39.8		39.4	39		50	
55	53.4	52.1	51.8	43.1	42.1	41.7	45.2	44.5	44.3	39.4	38.9	38.9	38.7	38.2	38.4	55	
60	51	49.8	49.5	41.2	40.3	39.9	43.5	42.8	42.6	38.3	37.9	37.8	37.7	37.3	37.3	60	
65	48.8	47.6	47.3	39.3	38.4	38.1	41.7	41	40.9	37	36.7	36.5	36.5	36.2	36.2	65	
70	46.6	45.6	45.3	37.4	36.7	36.4	40	39.4	39.3	35.8	35.3	35.2	35.3	35	34.9	70	
75	44.5	43.7	43.4	35.6	35.1	34.9	38.4	37.8	37.7	34.4	34	33.8	34.1	33.7	33.6	75	
80	42.5	41.8	41.6	33.9	33.5	33.4	36.9	36.3	36.2	33.1	32.7	32.6	32.8	32.4	32.4	80	
85	40.6	40	39.9	32.2	31.9	31.9	35.4	34.9	34.8	31.7	31.4	31.4	31.5	31.2	31.2	85	
90	38.7	38.2	38.2	30.7	30.4	30.4	34	33.5	33.5	30.3	30.1	30.1	30.1	30.2	29.9	30	90
95	36.8	36.5	36.5	29.2	29	29.1	32.6	32.2	32.2	29.1	28.8	28.9	29	28.7	28.8	95	
100	34.9	34.9	34.9	27.9	27.7	27.8	31.4	31	31	27.9	27.7	27.7	27.8	27.6	27.7	100	
105	33.1	33.2	33.3	26.6	26.5	26.6	30.2	29.9	29.9	26.7	26.6	26.6	26.7	26.5	26.6	105	
110	31.4	31.6	31.8	25.4	25.3	25.4	29.1	28.8	28.9	25.7	25.5	25.6	25.7	25.5	25.6	110	
115	29.7	30	30.2	24.3	24.2	24.3	27.9	27.8	27.9	24.7	24.6	24.6	24.7	24.5	24.6	115	
120	28.1	28.4	28.6	23.3	23.2	23.3	26.9	26.8	26.9	23.7	23.6	23.7	23.7	23.6	23.7	120	
125	26.7	26.9	27.1	22.3	22.3	22.3	25.8	25.8	25.9	22.8	22.7	22.8	22.8	22.7	22.8	125	
130	25.4	25.6	25.7	21.4	21.4	21.4	24.7	24.8	25	22	21.9	22	21.9	22	21.9	130	
135	23.9	24.2	24.3	20.5	20.5	20.6	23.5	23.7	23.9	21.1	21.1	21.2	20.9	21	21.2	135	
140	22.4	22.6	22.6	19.7	19.7	19.8	22.4	22.6	22.8	20.4	20.3	20.4	20.1	20.2	20.4	140	
145	21.6	21.6	21.7	18.9	18.9	19	21.3	21.5	21.7	19.6	19.6	19.7	19.3	19.4	19.6	145	
150	20.8	20.8	20.9	18.1	18.1	18.2	20.1	20.3	20.4	18.9	18.9	19.1	18.5	18.6	18.8	150	
155	19.9	20	17.8	17.4	17.4	17.5	18.8	19	19.1	18.2	18.3	18.4	17.7	17.8	18	155	
160	18.7	18.9	13.6	16.7	16.7	16.8	17.6	17.8	17.8	17.6	17.6	17.7	17	17.2	17.3	160	
165	17.6	17.7		16	16.1	15.9	16.5	16.6	16.6	16.7	16.8	16.9	16.3	16.5	16.5	165	
170	16.6	16.7		15.5	15.5	12.9	15.4	15.6	15.3	15.7	15.8	15.9	15.5	15.7	15.7	170	
175	15	16.7		14.9	14.9		14.5	14.6	14.6	14.7	14.8	14.8	14.5	14.7	14.7	175	
180	10.5			14.4	14.4		13.5	13.6		13.7	13.9	13.6	13.6	13.7	13.7	180	
185				13			12.7			12.9	13		12.7	12.8	12.7	185	
190				8.7			10.6			12	12.1		11.9	12		190	
195							6.2			11.3			11.1	11.2		195	
200										9			9.9			200	
205										5.1			6.8			205	

† 259_106_10151 / 30151_00_000

Lifting capacities

Forces de levage

TNZK

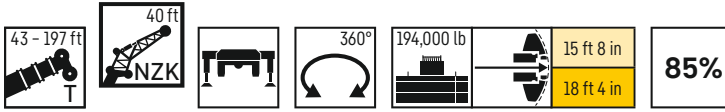

	43 ft			99 ft			114 ft			128 ft			142 ft			156 ft			
	0°	22,5°	45°	0°	22,5°	45°	0°	22,5°	45°	0°	22,5°	45°	0°	22,5°	45°	0°	22,5°	45°	
10	46.1																		10
11	46.1																		11
12	46.1																		12
13	46.1																		13
14	46.1																		14
15	46.1																		15
16	46.1																		16
17	46.1			46.1															17
18	46.1			46.1															18
19	46.1			46.1			46.1												19
20	46.1			46.1			46.1												20
22	46.1	45.8		46.1			46.1			46.1									22
24	46.1	44.5		46.1			46.1			46.1									24
26	46.1	42.6		46.1			46.1			46.1			46.1						26
28	46.1	40.8		46.1			46.1			46.1			46.1						28
30	46.1	39.1		46.1			46.1			46.1			46.1						30
32	45.8	37.6		46.1	45.7		46.1			46.1			46.1			45.7			32
34	44.5	36.2	27.9	46.1	44.8		46.1			46.1			46.1			45.5			34
36	43.1	35	27.3	46.1	43.7		46.1	44.1		46.1			46.1			45.3			36
38	41.8	33.8	26.7	46.1	42.6		46.1	43.3		46.1			46.1			45			38
40	40.4	32.7	26.2	46.1	41.5		46.1	42.4		46.1	41.8		46.1			44.6			40
45	36.9	30.3	25	46.1	39	27.8	46.1	40.1	28	46.1	40.2		46.1	39		43.7			45
50	33.1	28.3	24	46.1	36.9	26.9	46.1	38	27.2	46.1	38.5	27.3	46.1	37.7		42.7	36		50
55	29.8	26.5	23.4	46	35.1	26.2	45.8	36.2	26.5	45.7	36.7	26.6	45.2	36.4	26.7	41.6	34.8		55
60	27	24.9	22.9	44.6	33.3	25.5	45.2	34.5	25.8	44.9	35.2	26	43.6	34.9	26.1	40.5	33.6	26	60
65	24.6	23.5	22.7	42.6	31.9	24.9	43.9	33	25.2	43.7	33.7	25.5	42.1	33.6	25.5	39.3	32.5	25.5	65
70	22.7	22.3	15.3	40.6	30.6	24.4	42	31.7	24.8	41.9	32.5	24.9	40.6	32.3	25.1	38.3	31.4	25	70
75	21	21.6		38.5	29.3	23.9	40	30.5	24.3	40.2	31.2	24.5	39.3	31.2	24.6	37.2	30.4	24.6	75
80				36.4	28.2	23.6	38.2	29.5	23.9	38.7	30.1	24.1	38	30.1	24.3	36.2	29.5	24.2	80
85				34.1	27.3	23.3	36.5	28.4	23.6	37.2	29	23.8	36.8	29.1	23.9	35.2	28.6	23.9	85
90				32	26.3	23	34.7	27.4	23.3	35.7	28.1	23.5	35.6	28.2	23.6	34.2	27.7	23.6	90
95				30.1	25.4	22.9	32.9	26.5	23.1	34.2	27.1	23.2	34.4	27.3	23.4	33.2	27	23.4	95
100				28.3	24.6	22.8	31.2	25.6	22.9	32.7	26.3	23	33.1	26.5	23.1	32.2	26.2	23.1	100
105				26.7	23.8	22.7	29.6	24.8	22.8	31.3	25.5	22.8	31.8	25.8	23	31.2	25.6	22.9	105
110				25.3	23.1	22.6	28.1	24.1	22.6	29.9	24.8	22.7	30.6	25.1	22.8	30.2	25	22.7	110
115				24.1	22.5	17.4	26.7	23.5	22.5	28.7	24.1	22.5	29.5	24.4	22.5	29.1	24.3	22.4	115
120				22.9	22		25.4	22.9	22.4	27.5	23.5	22.4	28.3	23.8	22.3	28	23.8	22.1	120
125				21.9	21.7		24.3	22.3	19.2	26.4	22.9	22.2	27.3	23.3	22.1	26.8	23.3	21.9	125
130				20.9			23.2	21.9	16.9	25.2	22.4	22.2	26.2	22.8	22	25.5	22.8	21.8	130
135							22.3	21.5		24.2	22	20.1	25.2	22.3	21.9	24.2	22.4	21.7	135
140							21.4	21.4		23.3	21.6	14.5	24.1	21.9	21.9	22.8	22	21.6	140
145							19.5			22.1	21.3	14	22.6	21.6	21.7	21.3	21.5	21.5	145
150										20.7	21.1		21.2	21.2	17.7	20.2	20.8	20.9	150
155										18.6			19.9	20.5	16.6	19.5	19.5	19.7	155
160										14.1			18.8	19.2	15.1	18.8	18.8	14.9	160
165													17.7	18		17.8	18.2	14.4	165
170													15.1	16.7		16.7	17.2	13.6	170
175													12.3			15.8	16.1		175
180																14.8	15.2		180
185																13.3	13.8		185
190																7.7			190

t_259_106.11151 / 31151.00.000

Lifting capacities

Forces de levage

TNZK

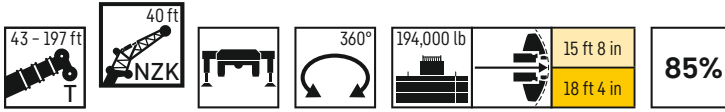

	170 ft			180 ft			184 ft 40 ft			194 ft			197 ft			
	0°	22,5°	45°	0°	22,5°	45°	0°	22,5°	45°	0°	22,5°	45°	0°	22,5°	45°	
36	39.4															36
38	39.2			33.2												38
40	39			33.1			33.4									40
45	38.4			32.7			33			29.8			29.2			45
50	37.8			32.4			32.7			29.5			28.9			50
55	37.2	32.5		32.1			32.4			29.3			28.7			55
60	36.5	31.6		31.7	28.6		32	28.9		29.1	27		28.5			60
65	35.7	30.6	25.2	31.2	27.9		31.6	28.2		28.8	26.5		28.3	26.2		65
70	34.9	29.8	24.8	30.6	27.3	24	31.1	27.6	24.2	28.5	26		28	25.7		70
75	34.2	28.9	24.4	29.7	26.7	23.6	30.6	27	23.8	28.1	25.5	23	27.7	25.3	22.9	75
80	33.5	28.2	24	28.7	26.1	23.3	30.1	26.4	23.4	27.4	25	22.7	27.1	24.8	22.5	80
85	32.7	27.4	23.8	27.6	25.5	22.9	29.2	25.8	23.1	26.7	24.6	22.4	26.4	24.3	22.3	85
90	31.9	26.8	23.5	26.4	24.8	22.6	28.3	25.2	22.7	25.8	24.1	22.1	25.6	23.9	22	90
95	31.1	26.1	23.2	25.4	24.1	22.3	27.3	24.7	22.4	24.9	23.6	21.8	24.8	23.5	21.7	95
100	30.2	25.5	22.8	24.4	23.3	22	26.4	24.2	22.1	24.1	23.1	21.6	23.9	22.9	21.5	100
105	29.2	24.9	22.5	23.4	22.5	21.6	25.4	23.7	21.9	23.2	22.4	21.3	23.1	22.3	21.2	105
110	28.1	24.4	22.3	22.5	21.8	21.2	24.5	23.2	21.6	22.4	21.7	21	22.3	21.6	20.9	110
115	27.1	23.9	22	21.6	21	20.7	23.7	22.6	21.4	21.6	21	20.6	21.5	20.9	20.5	115
120	26.1	23.4	21.8	20.6	20.3	20.2	22.9	22	21.2	20.8	20.3	20.1	20.7	20.3	20.1	120
125	25.1	22.9	21.6	19.8	19.6	19.6	22.1	21.5	21	20	19.7	19.6	20	19.7	19.6	125
130	24.2	22.5	21.5	19	18.9	19	21.4	20.9	20.6	19.3	19	19	19.2	19	19	130
135	23.2	22.1	21.4	18.2	18.2	18.4	20.7	20.3	20.1	18.5	18.4	18.5	18.5	18.4	18.5	135
140	22.1	21.7	21.3	17.5	17.5	17.7	20	19.7	19.7	17.9	17.8	17.9	17.9	17.8	17.9	140
145	21.1	21.1	21.1	16.9	16.9	17.1	19.4	19.1	19.2	17.2	17.1	17.4	17.3	17.2	17.4	145
150	20.1	20.4	20.5	16.2	16.2	16.5	18.8	18.5	18.7	16.6	16.6	16.8	16.6	16.6	16.8	150
155	18.9	19.6	19.9	15.6	15.6	15.9	18.2	18	18.2	16	16	16.2	16	16	16.3	155
160	17.7	18.4	18.8	15	15.1	15.3	17.5	17.5	17.7	15.5	15.5	15.7	15.5	15.5	15.7	160
165	16.6	17.3	17.6	14.5	14.5	14.8	16.8	17	17.2	15	15	15.2	14.9	15	15.2	165
170	16	16.1	16.4	13.9	14	14.3	16	16.4	16.7	14.5	14.5	14.7	14.4	14.5	14.8	170
175	15.5	15.6	12.5	13.5	13.5	13.8	15	15.6	15.9	14	14	14.2	13.8	14	14.3	175
180	15	15.1	12	13	13.1	13.1	14.1	14.6	14.9	13.5	13.6	13.8	13.3	13.6	13.8	180
185	14.3	14.6	11.5	12.5	12.7	8.8	13.2	13.7	10.8	13.1	13.1	13.4	12.8	13.1	13.3	185
190	13.5	13.9		12.1	12.2	7.7	12.4	12.8	9.8	12.3	12.7	12.9	12.1	12.6	12.8	190
195	12.5			11.6	11.8	7	11.6	12	9.1	11.6	12	10.6	11.4	11.9	12	195
200	9.4			11.3	11.4		10.9	11.2	8.3	10.8	11.3	8	10.7	11.1	8.4	200
205	3.5			10.7	11		10.2	10.5	7.3	10.2	10.5	7.3	10	10.4	7.5	205
210				7.9			8.7	9.6		9.5	9.8		9.3	9.7	6.5	210
215							6			8.9	9.2		8.7	9		215
220										7.3			7.8	8.3		220
225										4.9			5.8			225
230													2.5			230

t_259_106_11151 / 31151_00_000

Lifting capacities

Forces de levage

TNZK

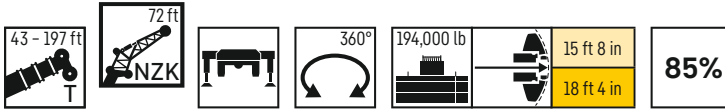

	43 ft			99 ft			114 ft			128 ft			142 ft			156 ft			
	0°	22,5°	45°	0°	22,5°	45°	0°	22,5°	45°	0°	22,5°	45°	0°	22,5°	45°	0°	22,5°	45°	
13	23.3																		13
14	23.3																		14
15	23.3																		15
16	23.3																		16
17	23.3																		17
18	23.2																		18
19	23.1																		19
20	23																		20
22	22.7			23.2															22
24	22.3			23.2															24
26	21.9			23.2			22.6												26
28	21.5			23.2			22.6		20.2										28
30	21			23.1			22.6		20.2			19.5							30
32	20.6			23			22.6		20.2			19.5							32
34	20.1			22.8			22.6		20.2			19.5			18.4				34
36	19.7			22.6			22.4		20.2			19.5			18.4				36
38	19.2			22.3			22.1		20.2			19.5			18.4				38
40	18.8	15.7		22			21.9		20.1			19.4			18.4				40
45	17.5	14.8		21.4			21.3		19.8			19.2			18.3				45
50	16.4	13.9		20.6	15.7		20.6		19.4			18.9			18.1				50
55	15.4	13.2		19.9	15.1		20	15.1	18.9			18.5			17.8				55
60	14.5	12.5	10.9	19.1	14.5		19.3	14.6	18.5	15.1		18.1	14.9		17.5				60
65	13.6	11.9	10.5	18.3	13.9		18.6	14.1	18	14.6		17.7	14.5		17.1	14.2			65
70	12.9	11.4	10.2	17.4	13.5	10.9	17.9	13.6	17.6	14.2		17.3	14.1		16.8	13.9			70
75	12.2	11	9.9	16.7	13	10.7	17.2	13.2	10.7	17.1	13.8	11.2	16.9	13.7		16.4	13.5		75
80	11.6	10.5	9.7	16	12.6	10.4	16.5	12.8	10.5	16.6	13.4	11	16.5	13.4	10.9	16.1	13.2		80
85	10.9	10.2	9.6	15.3	12.2	10.3	15.9	12.4	10.3	16.2	13	10.8	16.1	13	10.7	15.7	12.9	10.6	85
90	10.2	9.9	9.5	14.7	11.8	10.1	15.2	12.1	10.1	15.7	12.7	10.6	15.7	12.7	10.5	15.4	12.6	10.5	90
95	9.6	9.7	9.5	14.1	11.5	9.9	14.7	11.7	10	15.3	12.4	10.4	15.3	12.4	10.4	15.1	12.3	10.3	95
100	9.1	9.5	9.5	13.6	11.2	9.8	14.1	11.4	9.8	14.8	12.1	10.3	14.9	12.1	10.3	14.7	12	10.2	100
105	8.6	9.1		13.1	10.9	9.7	13.6	11.1	9.7	14.4	11.8	10.2	14.5	11.9	10.1	14.4	11.8	10.1	105
110				12.6	10.7	9.6	13.1	10.9	9.6	13.9	11.5	10	14.1	11.6	10	14	11.6	10	110
115				12.2	10.4	9.6	12.7	10.7	9.5	13.5	11.3	10	13.7	11.4	9.9	13.7	11.3	9.9	115
120				11.7	10.2	9.5	12.3	10.4	9.5	13.1	11.1	9.9	13.3	11.2	9.9	13.3	11.1	9.8	120
125				11.3	10	9.5	11.9	10.2	9.4	12.7	10.9	9.8	12.9	11	9.8	13	10.9	9.7	125
130				10.9	9.9	9.5	11.5	10.1	9.4	12.3	10.7	9.8	12.6	10.8	9.7	12.7	10.8	9.7	130
135				10.4	9.7	9.5	11.2	9.9	9.4	12	10.5	9.7	12.3	10.6	9.7	12.4	10.6	9.6	135
140				9.9	9.6	9.5	10.8	9.7	9.4	11.7	10.3	9.7	12	10.4	9.7	12.1	10.4	9.6	140
145				9.6	9.5	9.5	10.4	9.6	9.4	11.4	10.2	9.7	11.7	10.3	9.7	11.8	10.3	9.6	145
150				9.2	9.5	9.5	10	9.5	9.4	11.1	10.1	9.7	11.4	10.1	9.7	11.5	10.2	9.6	150
155				8.9	9.5	9.2	9.7	9.5	9.4	10.9	9.9	9.7	11.1	10	9.7	11.3	10	9.6	155
160				8.6	9.5		9.3	9.4	9.4	10.6	9.9	9.7	10.9	9.9	9.7	11	9.9	9.6	160
165				8.4			9	9.4	9.4	10.4	9.8	9.7	10.7	9.8	9.7	10.8	9.8	9.6	165
170							8.7	9.4		10.1	9.8	9.7	10.4	9.8	9.7	10.6	9.7	9.6	170
175							8.5	9.4		9.9	9.7	9.7	10.2	9.7	9.7	10.4	9.7	9.6	175
180							8.3			9.6	9.7	9.7	10.1	9.7	9.7	10.2	9.6	9.6	180
185										9.3	9.7		9.8	9.7	9.7	10.1	9.6	9.6	185
190										9.1	9.7		9.6	9.7	9.6	9.9	9.6	9.6	190
195													9.4	9.7		9.8	9.6	9.6	195
200													9.2	9.7		9.6	9.6	9.6	200
205													8.9			9.4	9.6	9.6	205
210																9.2	9.6		210
215																9			215
220																7.3			220

t_259_106_13151 / 33151_00_000

Lifting capacities

Forces de levage

TNZK

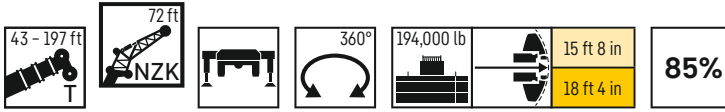

	170 ft			180 ft			184 ft			194 ft			197 ft			
	0°	22,5°	45°	0°	22,5°	45°	0°	22,5°	45°	0°	22,5°	45°	0°	22,5°	45°	
38	17															38
40	17			15.3												40
45	17			15.3			15.4			14.3			14.1			45
50	16.9			15.2			15.4			14.3			14.1			50
55	16.8			15.2			15.3			14.3			14.1			55
60	16.6			15.2			15.3			14.3			14.1			60
65	16.3			15			15.2			14.2			14			65
70	16	13.5		14.8			15			14.2			14			70
75	15.7	13.2		14.6	12.6		14.7	12.7		14			13.9			75
80	15.4	12.9		14.4	12.3		14.5	12.4		13.8	12		13.7	12		80
85	15.1	12.6		14.1	12.1		14.3	12.2		13.6	11.8		13.5	11.8		85
90	14.9	12.4	10.3	13.9	11.8		14	11.9		13.4	11.6		13.3	11.6		90
95	14.6	12.1	10.2	13.7	11.6	10	13.8	11.7	10	13.3	11.4	9.9	13.2	11.4		95
100	14.3	11.8	10.1	13.5	11.4	9.9	13.6	11.5	9.9	13.1	11.2	9.8	13	11.2	9.7	100
105	14	11.6	10	13.2	11.2	9.8	13.3	11.3	9.8	12.9	11	9.7	12.8	11	9.7	105
110	13.7	11.4	9.9	13	11	9.7	13.1	11.1	9.7	12.7	10.8	9.6	12.6	10.8	9.6	110
115	13.4	11.2	9.8	12.7	10.9	9.6	12.8	10.9	9.7	12.5	10.7	9.5	12.4	10.7	9.5	115
120	13.1	11	9.7	12.5	10.7	9.6	12.6	10.8	9.6	12.2	10.5	9.5	12.2	10.5	9.5	120
125	12.8	10.8	9.6	12.2	10.5	9.5	12.4	10.6	9.5	12	10.4	9.4	12	10.4	9.4	125
130	12.5	10.7	9.6	12	10.4	9.5	12.1	10.5	9.5	11.8	10.3	9.4	11.8	10.2	9.4	130
135	12.2	10.5	9.6	11.8	10.2	9.4	11.9	10.3	9.4	11.6	10.1	9.3	11.6	10.1	9.3	135
140	12	10.4	9.5	11.5	10.1	9.4	11.7	10.2	9.4	11.4	10	9.3	11.4	10	9.3	140
145	11.7	10.2	9.5	11.3	10	9.4	11.5	10.1	9.4	11.2	9.9	9.3	11.2	9.9	9.3	145
150	11.5	10.1	9.5	11.1	9.9	9.4	11.3	9.9	9.3	11	9.8	9.3	11	9.8	9.3	150
155	11.3	10	9.5	10.9	9.8	9.4	11.1	9.8	9.3	10.9	9.7	9.3	10.8	9.7	9.3	155
160	11.1	9.9	9.5	10.8	9.7	9.4	10.9	9.7	9.3	10.7	9.6	9.3	10.7	9.6	9.3	160
165	10.8	9.8	9.5	10.6	9.6	9.4	10.7	9.7	9.3	10.5	9.5	9.3	10.5	9.5	9.3	165
170	10.6	9.7	9.5	10.4	9.5	9.4	10.5	9.6	9.3	10.4	9.5	9.3	10.4	9.5	9.3	170
175	10.5	9.6	9.5	10.3	9.5	9.4	10.4	9.5	9.3	10.2	9.4	9.3	10.2	9.4	9.3	175
180	10.3	9.6	9.5	10.1	9.4	9.4	10.2	9.5	9.3	10.1	9.4	9.3	10.1	9.3	9.3	180
185	10.1	9.5	9.5	10	9.4	9.4	10.1	9.4	9.3	9.9	9.3	9.3	10	9.3	9.3	185
190	10	9.5	9.5	9.8	9.4	9.4	9.9	9.4	9.3	9.8	9.3	9.3	9.8	9.2	9.3	190
195	9.8	9.5	9.5	9.7	9.3	9.4	9.8	9.3	9.3	9.7	9.3	9.3	9.7	9.2	9.3	195
200	9.7	9.5	9.5	9.5	9.3	9.4	9.7	9.3	9.3	9.6	9.2	9.3	9.6	9.2	9.3	200
205	9.6	9.5	9.5	9.4	9.3	9.4	9.6	9.3	9.3	9.5	9.2	9.3	9.5	9.2	9.3	205
210	9.5	9.5	9.5	9.1	9.2	9.4	9.5	9.3	9.3	9.3	9.2	9.3	9.4	9.2	9.3	210
215	9.3	9.5	9.5	8.8	9	9.3	9.4	9.3	9.3	9.1	9.2	9.3	9.1	9.1	9.3	215
220	9.1	9.5	9	8.5	8.8	9.1	9.2	9.3	9.3	8.9	9.1	9.3	8.8	9.1	9.3	220
225	9	9.5		8.3	8.5	8.8	8.7	9.2	9.2	8.5	8.8	9.2	8.4	8.9	9.2	225
230	7.5			8.1	8.3		8.1	8.6	8.5	8	8.6	8.7	7.9	8.5	8.6	230
235	4.6			7.8	8		7.6	8		7.5	8.1	8	7.4	7.9	7.9	235
240				6.4			6.6	7.5		7.1	7.5	7.4	7	7.4		240
245				3.6			4.8			6.7	7		6.6	6.9		245
250										5.6	6.6		5.9	6.5		250
255										3.9			4.5			255

t_259_106_13151 / 33151_00_000

Lifting heights

Hauteurs de levage

TNZK



Lifting capacities

Forces de levage

TNZK

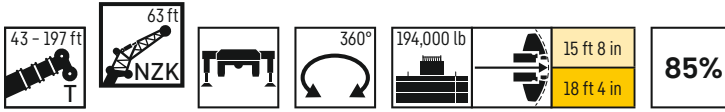

	43 ft			99 ft			114 ft			128 ft			142 ft			156 ft			
	0°	22,5°	45°	0°	22,5°	45°	0°	22,5°	45°	0°	22,5°	45°	0°	22,5°	45°	0°	22,5°	45°	
12	40.2																		12
13	40.2																		13
14	40.2																		14
15	39.8																		15
16	39.5																		16
17	39.1																		17
18	38.8																		18
19	38.4																		19
20	38																		20
22	37			40.2															22
24	35.9			40.1			38.2												24
26	34.7			39.7			38.2												26
28	33.6			39.3			37.9			35.5									28
30	32.5			38.8			37.6			35.4									30
32	31.5			38.3			37.3			35.3			32.5						32
34	30.5			37.8			36.9			35			32.5			29.3			34
36	29.5	23.7		37.1			36.4			34.6			32.2			29.2			36
38	28.5	23		36.4			35.9			34.1			31.9			29			38
40	27.6	22.3		35.6			35.2			33.7			31.5			28.8			40
45	25	20.6		33.8	24		33.6			32.5			30.6			28.1			45
50	22.3	19.3		32	22.8		32.1	23		31.4			29.7			27.4			50
55	20.1	18.1	15.2	30.4	21.8		30.6	22		30.1	21.9		28.8	21.5		26.8			55
60	18.2	16.9	14.6	28.8	20.7		29.2	21		28.9	21		27.9	20.8		26.1	20.3		60
65	16.6	15.8	14.1	27.3	19.8	15.4	27.9	20.2	15.4	27.8	20.2		27	20		25.4	19.6		65
70	15.3	14.9	13.6	25.5	19	15	26.7	19.4	15	26.7	19.5	15	26	19.3		24.7	18.9		70
75	14.1	14	13	23.7	18.3	14.6	25.3	18.6	14.7	25.6	18.8	14.7	25.1	18.7	14.6	24	18.4	14.4	75
80	13	13.3	12.6	22	17.5	14.3	23.8	18	14.4	24.6	18.1	14.4	24.3	18.1	14.3	23.3	17.8	14.2	80
85	12.1	12.7	12.3	20.6	16.8	14	22.3	17.3	14.1	23.4	17.5	14.1	23.4	17.5	14.1	22.6	17.2	13.9	85
90	11.3	12.1	12.1	19.3	16.2	13.7	20.9	16.6	13.8	22.1	16.9	13.8	22.4	16.9	13.8	21.9	16.7	13.7	90
95	10.7	11.8		18.1	15.5	13.4	19.7	16.1	13.6	20.8	16.3	13.6	21.5	16.4	13.6	21.1	16.2	13.5	95
100	10.1			17.1	15	13.1	18.5	15.5	13.3	19.7	15.8	13.3	20.4	15.9	13.4	20.3	15.7	13.3	100
105				16.1	14.5	12.9	17.5	15	13	18.7	15.3	13.1	19.4	15.4	13.1	19.6	15.2	13	105
110				15.3	14	12.6	16.6	14.5	12.8	17.8	14.8	12.9	18.5	14.9	12.9	18.8	14.8	12.8	110
115				14.5	13.5	12.4	15.8	14	12.6	16.9	14.3	12.7	17.7	14.5	12.7	18.1	14.4	12.6	115
120				13.8	13.1	12.3	15	13.6	12.4	16.1	14	12.5	16.9	14.1	12.5	17.3	14.1	12.4	120
125				13.1	12.7	12.2	14.3	13.2	12.3	15.4	13.6	12.3	16.2	13.7	12.3	16.7	13.7	12.3	125
130				12.5	12.4	12.2	13.7	12.9	12.2	14.7	13.2	12.2	15.5	13.4	12.2	16	13.4	12.1	130
135				11.9	12.1	12.1	13.1	12.6	12.1	14.1	12.9	12.1	14.9	13.1	12	15.4	13.1	12	135
140				11.4	11.9		12.5	12.3	12.1	13.5	12.6	12	14.3	12.8	11.9	14.8	12.8	11.9	140
145				11	11.8		12	12	12.1	13	12.3	11.9	13.7	12.5	11.9	14.3	12.6	11.8	145
150				10.6			11.5	11.8	12.1	12.5	12.1	11.9	13.2	12.3	11.8	13.8	12.3	11.7	150
155				10.2			11.1	11.7		12	11.9	11.9	12.8	12	11.8	13.3	12.1	11.6	155
160							10.7	11.6		11.6	11.7	11.9	12.3	11.8	11.8	12.9	11.9	11.6	160
165							10.4			11.2	11.5		11.9	11.6	11.8	12.5	11.7	11.6	165
170							10.1			10.8	11.5		11.5	11.5	11.8	12.1	11.5	11.6	170
175										10.5	11.4		11.2	11.4	11.1	11.7	11.4	11.6	175
180										10.2			10.9	11.3		11.4	11.3	11.6	180
185										9.6			10.6	11.3		11.1	11.2	11.6	185
190													10.3			10.8	11.1	9.3	190
195													10			10.6	11.1		195
200																10.3	11.1		200
205																10.1			205
210																8.6			210

t 259_106_12151 / 32151_00_000

Lifting capacities

Forces de levage

TNZK

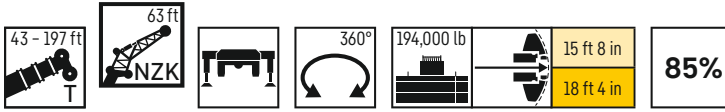

	170 ft			180 ft			184 ft			194 ft			197 ft			
	0°	22,5°	45°	0°	22,5°	45°	0°	22,5°	45°	0°	22,5°	45°	0°	22,5°	45°	
38	25.6															38
40	25.5			21												40
45	25.2			20.9			21.1			19.1			18.8			45
50	24.7			20.9			21.1			19.1			18.7			50
55	24.2			20.8			21			19			18.7			55
60	23.7			20.6			20.8			19			18.6			60
65	23.2	18.8		20.3			20.5			18.8			18.5			65
70	22.8	18.3		20	17.7		20.2	17.9		18.6			18.3			70
75	22.3	17.7		19.7	17.3		19.9	17.5		18.4	16.6		18.1	16.5		75
80	21.7	17.2	13.9	19.4	16.8		19.6	17		18.2	16.2		17.9	16.1		80
85	21.2	16.7	13.7	19	16.4	14.1	19.3	16.6	14.3	18	15.9		17.7	15.7		85
90	20.7	16.2	13.5	18.7	16	13.9	18.9	16.2	14	17.7	15.5	13.6	17.5	15.4	13.5	90
95	20.1	15.7	13.2	18.3	15.7	13.7	18.6	15.9	13.8	17.4	15.2	13.4	17.2	15.1	13.4	95
100	19.5	15.3	13	18	15.3	13.4	18.2	15.5	13.5	17.1	14.9	13.2	16.9	14.8	13.2	100
105	18.9	15	12.8	17.7	14.9	13.2	17.9	15.2	13.3	16.9	14.6	13	16.7	14.5	13	105
110	18.3	14.6	12.6	17.4	14.6	13.1	17.6	14.8	13.1	16.6	14.3	12.8	16.4	14.2	12.8	110
115	17.8	14.2	12.4	17	14.3	12.9	17.2	14.5	13	16.3	14	12.7	16.2	14	12.6	115
120	17.2	13.9	12.3	16.7	14	12.8	16.9	14.2	12.8	16.1	13.8	12.6	15.9	13.7	12.5	120
125	16.7	13.6	12.1	16.3	13.8	12.6	16.5	13.9	12.7	15.8	13.5	12.4	15.7	13.5	12.4	125
130	16.1	13.3	12	15.9	13.5	12.5	16.1	13.7	12.5	15.5	13.3	12.3	15.4	13.2	12.3	130
135	15.6	13	11.8	15.5	13.3	12.4	15.8	13.4	12.4	15.2	13.1	12.2	15.1	13	12.2	135
140	15	12.7	11.7	15.1	13.1	12.3	15.4	13.2	12.3	14.9	12.8	12.1	14.8	12.8	12	140
145	14.5	12.5	11.6	14.7	12.8	12.2	15.1	13	12.2	14.6	12.7	12	14.5	12.6	12	145
150	14.1	12.3	11.6	14.2	12.6	12.1	14.7	12.7	12.1	14.2	12.5	12	14.2	12.4	11.9	150
155	13.6	12	11.5	13.8	12.4	12.1	14.4	12.5	12.1	13.8	12.3	11.9	13.8	12.2	11.9	155
160	13.2	11.8	11.5	13.3	12.2	12	14.1	12.4	12	13.4	12.1	11.9	13.4	12.1	11.8	160
165	12.8	11.7	11.5	12.9	12.1	12	13.8	12.2	12	13	12	11.8	13	11.9	11.8	165
170	12.5	11.5	11.5	12.4	11.9	12	13.5	12	12	12.6	11.8	11.8	12.6	11.8	11.8	170
175	12.1	11.4	11.5	11.9	11.7	12	13.2	11.9	12	12.1	11.7	11.8	12.2	11.6	11.7	175
180	11.8	11.2	11.5	11.5	11.5	11.7	12.9	11.7	12	11.7	11.5	11.8	11.8	11.5	11.7	180
185	11.5	11.1	11.5	11.1	11.3	11.5	12.7	11.6	12	11.4	11.3	11.7	11.4	11.3	11.7	185
190	11.2	11	11.5	10.7	10.9	11.2	12.4	11.5	12	11	11.5	11	11	11	11.5	190
195	10.9	10.9	11.5	10.3	10.5	10.8	12.1	11.4	12	10.7	10.7	11.1	10.7	10.8	11.1	195
200	10.7	10.9	10.4	10	10.2	10.4	11.4	11.4	12	10.3	10.5	10.8	10.3	10.5	10.8	200
205	10.4	10.8		9.6	9.8	10.1	10.7	11.3	11.7	10	10.1	10.5	10	10.2	10.5	205
210	10.2	10.8		9.3	9.5	9.3	10.1	10.7	10.8	9.7	9.9	10.1	9.7	9.9	10.2	210
215	10			9	9.2		9.4	10	8.8	9.3	9.6	9.9	9.2	9.6	9.8	215
220	8.4			8.7	8.9		8.8	9.3	6.8	8.8	9.2	9.5	8.6	9.2	9.3	220
225	5.7			8.5			8.3	8.7		8.2	8.7	8.1	8	8.6	8.6	225
230				7.3			7.5			7.7	8.1		7.5	8	7.1	230
235				4.7			5.7			7.2	7.5		7.1	7.4		235
240							2.9			6.4			6.6			240
245										4.7			5.2			245
250													3.1			250

t_259_106_12151 / 32151_00_000

Lifting capacities

Forces de levage

TNZK

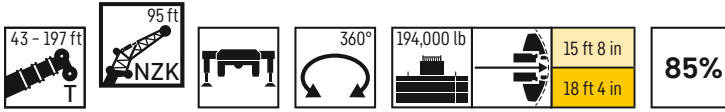

	43 ft			99 ft			114 ft			128 ft			142 ft			156 ft			
	0°	22,5°	45°	0°	22,5°	45°	0°	22,5°	45°	0°	22,5°	45°	0°	22,5°	45°	0°	22,5°	45°	
16	16.2																		16
17	16.2																		17
18	16.2																		18
19	16.2																		19
20	16.2																		20
22	16.3																		22
24	16.3																		24
26	16.3			16.2															26
28	16.2			16.2			15.9												28
30	16.2			16.2			15.9												30
32	16.2			16.2			15.9			15.3									32
34	16.1			16.2			15.9			15.3			14.6						34
36	16			16.2			15.9			15.3			14.5						36
38	15.7			16.2			15.8			15.2			14.5			13.6			38
40	15.5			16.2			15.8			15.2			14.5			13.6			40
45	14.7			16.2			15.7			15.1			14.4			13.5			45
50	13.8			16.1			15.7			15.1			14.4			13.5			50
55	13	11.1		15.8			15.6			15			14.3			13.4			55
60	12.2	10.5		15.3			15.2			14.9			14.2			13.4			60
65	11.5	9.9		14.7	11.2		14.8			14.6			14.1			13.3			65
70	10.8	9.3		14.1	10.8		14.3	10.8		14.2	10.7		13.9			13.2			70
75	10.1	8.8		13.6	10.3		13.7	10.4		13.7	10.4		13.5	10.3		13			75
80	9.5	8.4	7.2	13	9.9		13.2	10		13.2	10		13.1	9.9		12.6	9.7		80
85	9	7.9	7	12.4	9.5		12.7	9.6		12.8	9.7		12.6	9.6		12.3	9.4		85
90	8.4	7.6	6.8	11.9	9.2	7.3	12.2	9.3		12.3	9.3		12.2	9.3		11.9	9.1		90
95	8	7.3	6.6	11.4	8.8	7.1	11.7	9	7.1	11.9	9	7.1	11.8	9		11.6	8.9		95
100	7.5	7	6.4	10.9	8.5	6.9	11.2	8.7	7	11.5	8.7	7	11.4	8.7	6.9	11.2	8.6		100
105	7.1	6.7	6.3	10.4	8.2	6.8	10.8	8.4	6.8	11	8.4	6.8	11.1	8.5	6.8	10.9	8.4	6.7	105
110	6.7	6.5	6.2	9.9	7.9	6.7	10.4	8.1	6.7	10.6	8.2	6.7	10.7	8.2	6.7	10.5	8.1	6.6	110
115	6.4	6.4	6.1	9.5	7.7	6.6	10	7.8	6.6	10.2	8	6.6	10.3	8	6.6	10.2	7.9	6.6	115
120	6.1	6.2	6.1	9.1	7.5	6.5	9.6	7.6	6.5	9.8	7.7	6.5	9.9	7.8	6.5	9.9	7.7	6.5	120
125	5.8	6.1	6.1	8.7	7.3	6.4	9.2	7.4	6.4	9.5	7.5	6.4	9.6	7.6	6.4	9.6	7.5	6.4	125
130	5.6	6		8.4	7.1	6.3	8.9	7.2	6.3	9.1	7.4	6.3	9.3	7.4	6.3	9.3	7.4	6.3	130
135				8	6.9	6.2	8.5	7.1	6.2	8.8	7.2	6.3	9	7.2	6.3	9	7.2	6.2	135
140				7.7	6.8	6.2	8.2	6.9	6.2	8.5	7	6.2	8.7	7.1	6.2	8.7	7.1	6.2	140
145				7.4	6.6	6.1	7.9	6.8	6.1	8.2	6.9	6.2	8.4	7	6.1	8.5	7	6.1	145
150				7.1	6.5	6.1	7.6	6.6	6.1	8	6.8	6.1	8.2	6.8	6.1	8.2	6.8	6	150
155				6.8	6.4	6.1	7.3	6.5	6.1	7.7	6.6	6.1	7.9	6.7	6	8	6.7	6	155
160				6.6	6.3	6.1	7.1	6.4	6.1	7.5	6.5	6	7.7	6.6	6	7.8	6.6	5.9	160
165				6.3	6.2	6.1	6.8	6.3	6.1	7.3	6.4	6	7.5	6.5	6	7.6	6.5	5.9	165
170				6.1	6.2	6.1	6.6	6.2	6.1	7	6.3	6	7.3	6.4	6	7.4	6.4	5.9	170
175				5.9	6.1	6.1	6.4	6.1	6.1	6.8	6.2	6	7.1	6.3	6	7.2	6.3	5.9	175
180				5.7	6.1		6.2	6.1	6.1	6.6	6.1	6	6.9	6.2	6	7.1	6.2	5.9	180
185				5.6			6	6.1	6.1	6.4	6.1	6	6.7	6.1	6	6.9	6.2	5.9	185
190							5.8	6.1		6.2	6.1	6	6.5	6.1	6	6.8	6.1	5.9	190
195							5.7	6.1		6	6	6	6.3	6	6	6.6	6	5.9	195
200							5.5	6.1		5.9	6	6	6.2	6	6	6.4	6	5.9	200
205										5.7	6		6	6	6	6.3	5.9	5.9	205
210										5.6			5.9	6	6	6.1	5.9	5.9	210
215										5.5			5.7	6	6	6	5.9	5.9	215
220													5.6	6		5.9	5.9	5.9	220
225													5.5			5.7	5.9	5.9	225
230													5.4			5.6	5.9		230
235																5.5	5.9		235
240																5.5			240
245																3.6			245

t_259_106_15151 / 35151_00_000

Lifting capacities

Forces de levage

TNZK

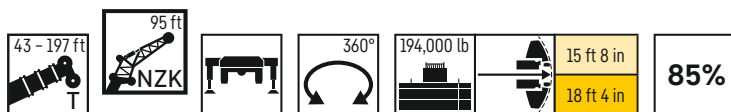

	170 ft			180 ft			184 ft			194 ft			197 ft			
	95 ft															
	0°	22,5°	45°	0°	22,5°	45°	0°	22,5°	45°	0°	22,5°	45°	0°	22,5°	45°	
45	12.5			11.1												45
50	12.4			11.1			11.2			10.4			10.2			50
55	12.4			11			11.1			10.3			10.2			55
60	12.3			11			11.1			10.3			10.1			60
65	12.3			11			11.1			10.3			10.1			65
70	12.2			11			11			10.2			10.1			70
75	12.2			10.9			11			10.2			10.1			75
80	12			10.9			11			10.2			10.1			80
85	11.7	9.1		10.7			10.8			10.2			10			85
90	11.4	8.9		10.5	8.4		10.6	8.5		10.1	8.2		9.9			90
95	11.1	8.6		10.2	8.2		10.4	8.3		9.8	8		9.8	8		95
100	10.8	8.4		10	8		10.1	8.1		9.6	7.8		9.6	7.8		100
105	10.5	8.2		9.8	7.8		9.9	7.9		9.4	7.7		9.4	7.6		105
110	10.2	8	6.6	9.5	7.6		9.7	7.7		9.2	7.5		9.2	7.5		110
115	9.9	7.8	6.5	9.3	7.5	6.3	9.4	7.5	6.3	9	7.4	6.2	9	7.3		115
120	9.6	7.6	6.4	9.1	7.3	6.2	9.2	7.4	6.3	8.8	7.2	6.2	8.8	7.2	6.2	120
125	9.4	7.4	6.3	8.8	7.2	6.2	9	7.3	6.2	8.6	7.1	6.1	8.6	7.1	6.1	125
130	9.1	7.3	6.2	8.6	7.1	6.1	8.7	7.1	6.1	8.4	7	6	8.4	7	6	130
135	8.9	7.1	6.1	8.4	7	6.1	8.5	7	6.1	8.2	6.9	6	8.2	6.8	6	135
140	8.6	7	6.1	8.2	6.8	6	8.3	6.9	6	8	6.8	5.9	8	6.7	5.9	140
145	8.4	6.9	6	8	6.7	6	8.1	6.8	6	7.9	6.7	5.9	7.8	6.6	5.9	145
150	8.2	6.8	6	7.8	6.6	5.9	7.9	6.6	5.9	7.7	6.6	5.9	7.7	6.5	5.8	150
155	8	6.7	6	7.6	6.5	5.9	7.7	6.5	5.9	7.6	6.5	5.8	7.5	6.4	5.8	155
160	7.7	6.6	5.9	7.5	6.4	5.8	7.5	6.5	5.9	7.4	6.4	5.8	7.4	6.4	5.8	160
165	7.5	6.5	5.9	7.3	6.4	5.8	7.4	6.4	5.8	7.3	6.3	5.8	7.3	6.3	5.7	165
170	7.4	6.4	5.9	7.2	6.3	5.8	7.3	6.3	5.8	7.1	6.2	5.7	7.1	6.2	5.7	170
175	7.2	6.3	5.9	7	6.2	5.8	7.1	6.2	5.8	7	6.2	5.7	7	6.1	5.7	175
180	7.1	6.2	5.8	6.9	6.1	5.8	7	6.1	5.8	6.9	6.1	5.7	6.9	6.1	5.7	180
185	6.9	6.1	5.8	6.8	6	5.8	6.9	6.1	5.8	6.8	6	5.7	6.8	6	5.7	185
190	6.8	6.1	5.8	6.7	6	5.8	6.7	6	5.8	6.7	5.9	5.7	6.6	5.9	5.7	190
195	6.7	6	5.8	6.6	5.9	5.8	6.6	5.9	5.8	6.6	5.9	5.7	6.5	5.9	5.7	195
200	6.6	6	5.8	6.5	5.9	5.8	6.5	5.9	5.8	6.5	5.8	5.7	6.4	5.8	5.7	200
205	6.4	5.9	5.8	6.3	5.8	5.8	6.4	5.8	5.8	6.4	5.8	5.7	6.4	5.8	5.7	205
210	6.3	5.9	5.8	6.3	5.8	5.8	6.3	5.8	5.8	6.3	5.8	5.7	6.2	5.7	5.7	210
215	6.2	5.8	5.8	6.1	5.8	5.8	6.2	5.8	5.8	6.2	5.7	5.7	6.2	5.7	5.7	215
220	6	5.8	5.8	6	5.7	5.8	6.1	5.8	5.8	6.1	5.7	5.7	6.1	5.7	5.7	220
225	5.9	5.8	5.8	5.9	5.7	5.8	6	5.7	5.8	6	5.7	5.7	6	5.7	5.7	225
230	5.8	5.8	5.8	5.8	5.7	5.8	5.9	5.7	5.8	5.9	5.7	5.7	5.9	5.6	5.7	230
235	5.7	5.8	5.8	5.7	5.7	5.8	5.8	5.7	5.8	5.8	5.7	5.7	5.9	5.6	5.7	235
240	5.6	5.8	5.8	5.6	5.7	5.8	5.7	5.7	5.8	5.8	5.7	5.7	5.8	5.6	5.7	240
245	5.5	5.8		5.6	5.7	5.8	5.6	5.7	5.8	5.7	5.7	5.7	5.7	5.6	5.7	245
250	5.4	5.8		5.5	5.7	5.8	5.6	5.7	5.8	5.6	5.7	5.7	5.6	5.6	5.7	250
255	4.7			5.4	5.7		5.5	5.7		5.6	5.7	5.7	5.6	5.6	5.7	255
260				5.4	5.7		5.4	5.7		5.5	5.7	5.7	5.5	5.6	5.7	260
265				3.8			4.2			5.3	5.7		5.2	5.6		265
270										4.7	5.4		4.8	5.3		270
275										3.3			3.7	4.9		275

t_259_106_35151 / 35151_00_000

Lifting heights

Hauteurs de levage

TNZK

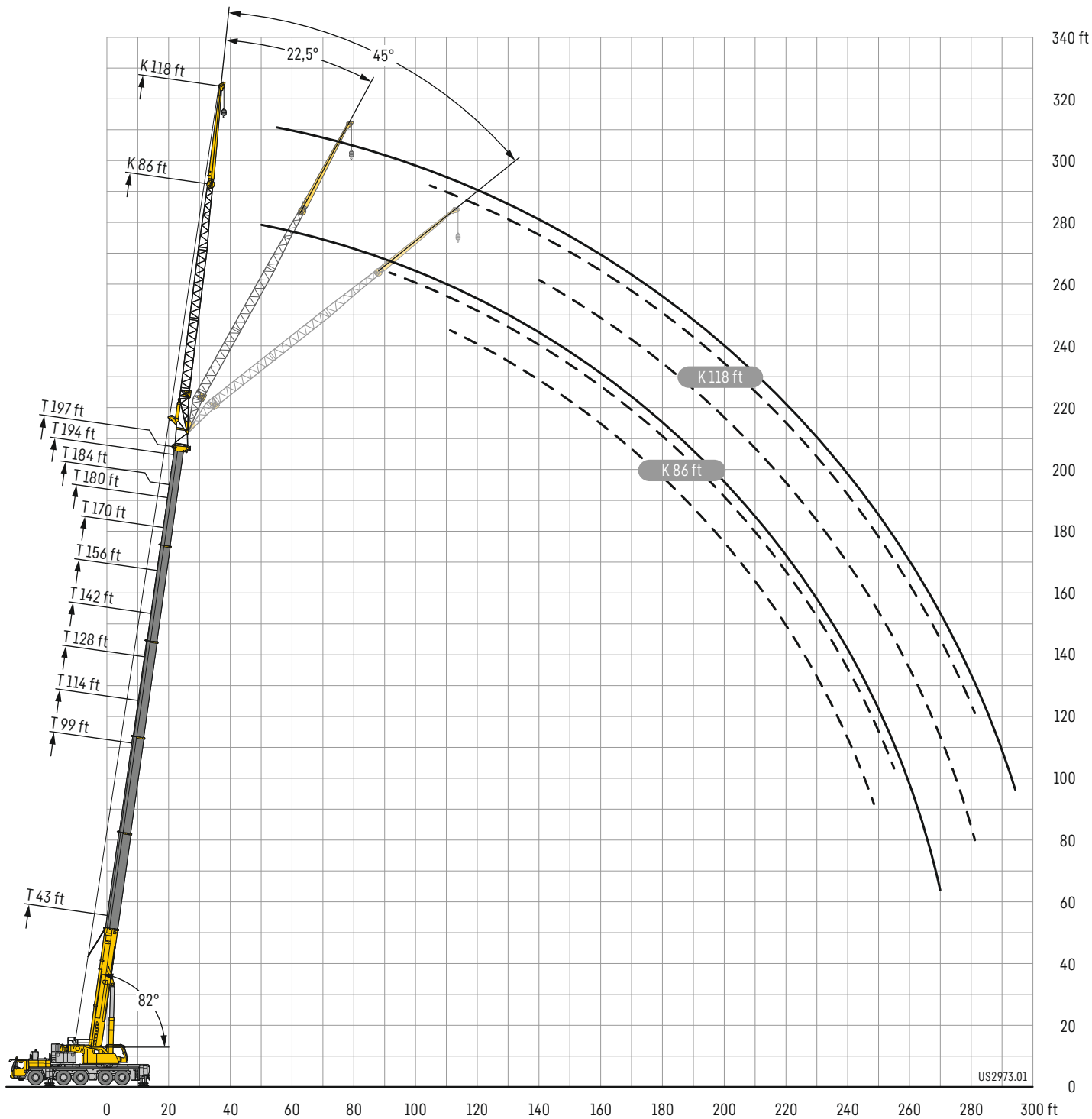

Lifting capacities

Forces de levage

TNZK

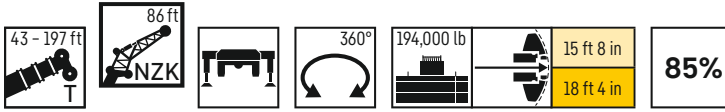

	43 ft			99 ft			114 ft			128 ft			142 ft			156 ft			
	0°	22,5°	45°	0°	22,5°	45°	0°	22,5°	45°	0°	22,5°	45°	0°	22,5°	45°	0°	22,5°	45°	
16	25.2																		16
17	25.2																		17
18	25.2																		18
19	25.2																		19
20	25.2																		20
22	25																		22
24	24.5																		24
26	23.9			25.2															26
28	23.2			25.2			24.2												28
30	22.6			25.2			24.2												30
32	21.9			25.1			24.2			22.8									32
34	21.1			25			24.1			22.8			20.6						34
36	20.4			24.6			24			22.7			20.5						36
38	19.7			24.2			23.7			22.6			20.5			18.6			38
40	19			23.7			23.3			22.4			20.4			18.6			40
45	17.5			22.6			22.4			21.7			20.3			18.5			45
50	16	12.9		21.4			21.5			20.9			20.1			18.4			50
55	14.8	12		20.1			20.4			20.1			19.6			18.2			55
60	13.7	11.2		18.9	13		19.3			19.2			19			17.8			60
65	12.6	10.5		17.8	12.4		18.3	12.5		18.2	12.4		18.4			17.4			65
70	11.6	9.9		16.8	11.8		17.3	11.9		17.4	12.1		17.8	12.8		16.9			70
75	10.7	9.4	8	15.8	11.3		16.4	11.5		16.5	11.6		17.1	12.3		16.4	12.1		75
80	9.8	8.9	7.7	15	10.8		15.5	11		15.7	11.2		16.5	11.9		15.9	11.7		80
85	9.1	8.4	7.4	14.2	10.4	8.1	14.7	10.5	8.1	15	10.8		15.9	11.5		15.4	11.3		85
90	8.4	8	7.2	13.4	10	7.8	14	10.2	7.9	14.3	10.5	8.2	15.2	11.1	8.4	14.8	10.9		90
95	7.8	7.7	7	12.7	9.6	7.7	13.3	9.8	7.7	13.6	10.1	8.1	14.6	10.7	8.3	14.3	10.6	8.2	95
100	7.4	7.4	6.9	12	9.3	7.5	12.7	9.5	7.5	13.1	9.8	7.9	14	10.4	8.1	13.8	10.3	8	100
105	7	7.1	6.8	11.3	8.9	7.3	12	9.1	7.4	12.5	9.5	7.7	13.5	10.1	7.9	13.3	10	7.9	105
110	6.6	7	6.8	10.7	8.6	7.2	11.4	8.8	7.3	11.9	9.2	7.6	13	9.8	7.8	12.8	9.7	7.7	110
115	6.3	6.8	6.8	10.1	8.4	7.1	10.9	8.6	7.1	11.4	9	7.5	12.4	9.5	7.6	12.4	9.4	7.6	115
120	6	6.8		9.5	8.1	7	10.3	8.3	7	10.9	8.8	7.4	12	9.2	7.5	12	9.2	7.5	120
125				9	7.8	6.9	9.8	8.1	6.9	10.5	8.5	7.3	11.5	9	7.4	11.6	9	7.4	125
130				8.6	7.6	6.9	9.3	7.9	6.9	10.1	8.3	7.2	11.1	8.7	7.3	11.2	8.7	7.3	130
135				8.1	7.4	6.8	8.9	7.6	6.8	9.7	8.1	7.2	10.7	8.5	7.3	10.8	8.5	7.2	135
140				7.7	7.3	6.8	8.5	7.5	6.8	9.3	7.9	7.1	10.3	8.3	7.2	10.5	8.3	7.1	140
145				7.4	7.1	6.8	8.1	7.3	6.7	9	7.7	7.1	10	8.1	7.1	10.1	8.2	7.1	145
150				7.1	7	6.8	7.7	7.2	6.7	8.6	7.6	7.1	9.6	8	7.1	9.8	8	7	150
155				6.9	6.9	6.8	7.4	7.1	6.7	8.3	7.5	7.1	9.2	7.8	7.1	9.5	7.8	7	155
160				6.7	6.9		7.2	6.9	6.7	8	7.4	7.1	8.9	7.6	7	9.2	7.7	7	160
165				6.4	6.8		6.9	6.9	6.7	7.7	7.3	7.1	8.5	7.5	7	8.9	7.5	6.9	165
170				6.2	6.8		6.7	6.8	6.7	7.4	7.2	7.1	8.2	7.4	7	8.6	7.4	6.9	170
175				6			6.5	6.8		7.2	7.1	7.1	7.9	7.3	7	8.3	7.3	6.9	175
180				6			6.3	6.7		7	7.1	7.1	7.6	7.2	7	8	7.2	6.9	180
185							6.1			6.8	7.1		7.4	7.1	7	7.7	7.1	6.9	185
190							6			6.6	7.1		7.2	7.1	7	7.5	7.1	6.9	190
195										6.5	7.1		7	7	7	7.3	7	6.9	195
200										6.3			6.8	7		7.1	7	6.9	200
205										6.2			6.6	7		6.9	6.9	6.9	205
210													6.5			6.8	6.9	6.9	210
215													6.3			6.6	6.9		215
220													6.2			6.5	6.9		220
225																6.4			225
230																6.2			230
235																5			235

t_259_106_14151 / 34151_00_000

Lifting capacities

Forces de levage

TNZK

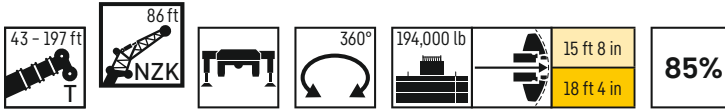

	170 ft			180 ft			184 ft			194 ft			197 ft			
	0°	22,5°	45°	0°	22,5°	45°	0°	22,5°	45°	0°	22,5°	45°	0°	22,5°	45°	
45	16.5			14.2			14.4									45
50	16.4			14.2			14.3			13			12.8			50
55	16.3			14.1			14.2			13			12.8			55
60	16.2			14.1			14.2			13			12.7			60
65	16			14			14.1			12.9			12.7			65
70	15.6			13.8			14			12.9			12.6			70
75	15.3			13.6			13.8			12.7			12.5			75
80	14.9	11.3		13.4			13.5			12.6			12.4			80
85	14.5	10.9		13.1	10.3		13.3	10.4		12.4	10		12.2			85
90	14.1	10.6		12.8	10		13	10.1		12.2	9.8		12	9.7		90
95	13.7	10.3		12.5	9.8		12.7	9.9		12	9.6		11.8	9.5		95
100	13.2	10	7.9	12.1	9.5		12.4	9.6		11.7	9.3		11.6	9.3		100
105	12.8	9.8	7.7	11.8	9.3	7.5	12	9.4	7.6	11.4	9.1		11.3	9.1		105
110	12.4	9.5	7.6	11.5	9.1	7.4	11.7	9.2	7.5	11.2	8.9	7.3	11.1	8.9	7.3	110
115	12	9.3	7.5	11.2	8.9	7.3	11.4	9	7.4	10.9	8.7	7.3	10.8	8.7	7.2	115
120	11.7	9	7.4	10.9	8.7	7.3	11.1	8.8	7.3	10.6	8.5	7.2	10.5	8.5	7.2	120
125	11.3	8.8	7.3	10.6	8.5	7.2	10.8	8.6	7.2	10.4	8.4	7.1	10.3	8.3	7.1	125
130	11	8.6	7.2	10.3	8.3	7.1	10.5	8.4	7.1	10.1	8.2	7	10.1	8.2	7	130
135	10.6	8.4	7.1	10.1	8.1	7	10.2	8.2	7.1	9.9	8.1	7	9.8	8	7	135
140	10.3	8.2	7.1	9.8	8	7	9.9	8.1	7	9.7	7.9	6.9	9.6	7.9	6.9	140
145	10	8.1	7	9.6	7.8	6.9	9.7	7.9	7	9.4	7.7	6.9	9.4	7.7	6.9	145
150	9.7	7.9	7	9.3	7.7	6.9	9.5	7.8	6.9	9.2	7.6	6.8	9.2	7.6	6.8	150
155	9.5	7.8	7	9.1	7.6	6.9	9.2	7.6	6.9	9	7.5	6.8	9	7.5	6.8	155
160	9.2	7.6	6.9	8.9	7.5	6.8	9	7.5	6.8	8.8	7.4	6.8	8.8	7.4	6.8	160
165	9	7.5	6.9	8.7	7.4	6.8	8.8	7.4	6.8	8.6	7.3	6.8	8.6	7.3	6.7	165
170	8.7	7.4	6.9	8.5	7.3	6.8	8.6	7.3	6.8	8.4	7.2	6.7	8.4	7.2	6.7	170
175	8.5	7.3	6.9	8.3	7.2	6.8	8.4	7.2	6.8	8.2	7.1	6.7	8.2	7.1	6.7	175
180	8.3	7.2	6.9	8.1	7.1	6.8	8.2	7.1	6.8	8.1	7.1	6.7	8.1	7	6.7	180
185	8	7.1	6.9	7.9	7	6.8	8	7.1	6.8	7.9	7	6.7	7.9	7	6.7	185
190	7.8	7	6.9	7.7	7	6.8	7.8	7	6.8	7.8	6.9	6.7	7.8	6.9	6.7	190
195	7.5	7	6.9	7.5	6.9	6.8	7.7	6.9	6.8	7.6	6.9	6.7	7.6	6.8	6.7	195
200	7.4	6.9	6.9	7.3	6.8	6.8	7.5	6.9	6.8	7.5	6.8	6.7	7.5	6.8	6.7	200
205	7.2	6.9	6.9	7.2	6.8	6.8	7.3	6.8	6.8	7.3	6.8	6.7	7.4	6.8	6.7	205
210	7	6.9	6.9	7	6.8	6.8	7.2	6.8	6.8	7.2	6.7	6.7	7.2	6.7	6.7	210
215	6.9	6.9	6.9	6.9	6.8	6.8	7	6.8	6.8	7.1	6.7	6.7	7.1	6.7	6.7	215
220	6.7	6.9	6.9	6.8	6.7	6.8	6.9	6.7	6.8	6.9	6.7	6.7	6.9	6.7	6.7	220
225	6.6	6.9		6.6	6.7	6.8	6.7	6.7	6.8	6.8	6.7	6.7	6.8	6.7	6.7	225
230	6.4	6.9		6.5	6.7	6.8	6.6	6.7	6.8	6.7	6.7	6.7	6.7	6.7	6.7	230
235	6.3			6.4	6.7		6.5	6.7	6.8	6.6	6.7	6.7	6.6	6.6	6.7	235
240	6.2			6.3	6.7		6.4	6.7	6.8	6.5	6.7	6.7	6.5	6.6	6.7	240
245	5.5			6.2			6.3	6.7		6.4	6.7	6.7	6.4	6.6	6.7	245
250				6.1			6.1			6.2	6.6		6	6.5	6.5	250
255				4.6			4.9			5.8	6.2		5.6	6.1		255
260							3			5.2			5.3			260
265										4			4.3			265
270													2.7			270

t_259_106_14151 / 34151_00_000

Lifting capacities

Forces de levage

TNZK

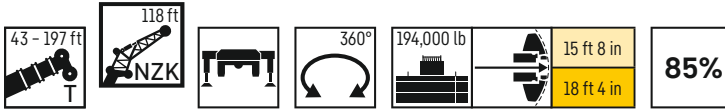

	43 ft			99 ft			114 ft			128 ft			142 ft			156 ft			
	0°	22,5°	45°	0°	22,5°	45°	0°	22,5°	45°	0°	22,5°	45°	0°	22,5°	45°	0°	22,5°	45°	
20	12.1																		20
22	12.1																		22
24	12																		24
26	12																		26
28	12																		28
30	11.9			12.1															30
32	11.9			12.1			11.7												32
34	11.8			12			11.7												34
36	11.8			12			11.6			11.2									36
38	11.7			12			11.6			11.1									38
40	11.6			12			11.6			11.1			10.5						40
45	11			11.9			11.5			11			10.5			9.8			45
50	10.4			11.8			11.4			11			10.4			9.7			50
55	9.8			11.6			11.4			10.9			10.3			9.7			55
60	9.2			11.2			11.1			10.8			10.3			9.6			60
65	8.6	7.2		10.8			10.8			10.6			10.2			9.5			65
70	8.1	6.9		10.3			10.4			10.2			10			9.5			70
75	7.6	6.5		9.9			10			9.9			9.7			9.3			75
80	7.1	6.2		9.4	7		9.6	7		9.5			9.3			9			80
85	6.7	5.9		9	6.7		9.2	6.8		9.1	6.8		9			8.7			85
90	6.4	5.6		8.5	6.5		8.8	6.5		8.8	6.5		8.7	6.5		8.4	6.3		90
95	6	5.4		8.2	6.3		8.4	6.3		8.4	6.3		8.4	6.3		8.1	6.2		95
100	5.8	5.1	4.5	7.8	6		8	6.1		8.1	6.1		8	6.1		7.9	6		100
105	5.5	4.9	4.3	7.4	5.8		7.7	5.9		7.8	5.9		7.8	5.9		7.6	5.8		105
110	5.2	4.7	4.2	7.1	5.6	4.5	7.4	5.7		7.5	5.7		7.5	5.7		7.4	5.6		110
115	4.9	4.5	4.1	6.8	5.4	4.4	7.1	5.5	4.4	7.2	5.6	4.4	7.2	5.5		7.1	5.5		115
120	4.7	4.4	4	6.6	5.3	4.3	6.8	5.3	4.3	6.9	5.4	4.3	7	5.4	4.3	6.9	5.3		120
125	4.5	4.2	3.9	6.3	5.1	4.2	6.6	5.2	4.3	6.7	5.2	4.2	6.8	5.2	4.2	6.7	5.2	4.2	125
130	4.3	4.1	3.8	6	5	4.1	6.3	5.1	4.2	6.5	5.1	4.2	6.5	5.1	4.2	6.5	5.1	4.1	130
135	4.1	3.9	3.7	5.8	4.8	4.1	6.1	4.9	4.1	6.2	5	4.1	6.3	5	4.1	6.3	5	4	135
140	3.9	3.8	3.7	5.6	4.7	4	5.8	4.8	4	6	4.8	4	6.1	4.9	4	6.1	4.8	4	140
145	3.7	3.8	3.7	5.4	4.5	3.9	5.7	4.7	4	5.8	4.7	4	5.9	4.7	3.9	5.9	4.7	3.9	145
150	3.5	3.7		5.2	4.4	3.9	5.5	4.5	3.9	5.7	4.6	3.9	5.7	4.6	3.9	5.8	4.6	3.8	150
155	3.4			5	4.3	3.8	5.3	4.4	3.8	5.5	4.5	3.8	5.6	4.5	3.8	5.6	4.5	3.8	155
160				4.9	4.2	3.8	5.1	4.3	3.8	5.3	4.4	3.8	5.4	4.4	3.8	5.5	4.4	3.8	160
165				4.7	4.1	3.7	4.9	4.2	3.8	5.1	4.3	3.8	5.2	4.3	3.7	5.3	4.3	3.7	165
170				4.5	4	3.7	4.8	4.1	3.7	5	4.2	3.7	5.1	4.2	3.7	5.2	4.2	3.7	170
175				4.4	3.9	3.7	4.6	4	3.7	4.8	4.1	3.7	4.9	4.1	3.7	5	4.1	3.6	175
180				4.2	3.9	3.7	4.5	4	3.7	4.7	4	3.7	4.8	4.1	3.6	4.9	4.1	3.6	180
185				4	3.8	3.7	4.4	3.9	3.7	4.5	3.9	3.6	4.7	4	3.6	4.8	4	3.6	185
190				3.9	3.8	3.7	4.2	3.8	3.7	4.4	3.9	3.6	4.5	3.9	3.6	4.6	3.9	3.6	190
195				3.8	3.7		4.1	3.8	3.7	4.3	3.8	3.6	4.4	3.9	3.6	4.5	3.9	3.5	195
200				3.6	3.7		3.9	3.7	3.7	4.2	3.8	3.6	4.3	3.8	3.6	4.4	3.8	3.5	200
205				3.5	3.7		3.8	3.7	3.7	4.1	3.7	3.6	4.2	3.7	3.6	4.3	3.8	3.5	205
210				3.4			3.7	3.7		3.9	3.7	3.6	4.1	3.7	3.6	4.2	3.7	3.5	210
215							3.6	3.7		3.8	3.7	3.6	4	3.7	3.6	4.1	3.7	3.5	215
220							3.5	3.7		3.7	3.6	3.6	3.9	3.6	3.6	4	3.6	3.5	220
225							3.4			3.6	3.6		3.8	3.6	3.6	3.9	3.6	3.5	225
230										3.5	3.6		3.7	3.6	3.6	3.9	3.6	3.5	230
235										3.4			3.6	3.6		3.8	3.5	3.5	235
240										3.4			3.5	3.6		3.7	3.5	3.5	240
245													3.5	3.6		3.6	3.5	3.5	245
250													3.4			3.5	3.5		250
255																3.5	3.5		255
260																3.4			260
265																3.4			265

t_259_106_16151 / 36151_00_000

Lifting capacities

Forces de levage

TNZK

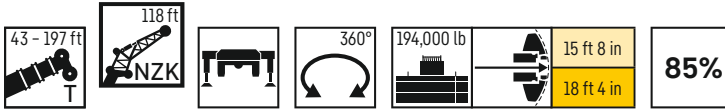

	170 ft			180 ft			184 ft 118 ft			194 ft			197 ft			
	0°	22,5°	45°	0°	22,5°	45°	0°	22,5°	45°	0°	22,5°	45°	0°	22,5°	45°	
50	8.9			7.8			7.9									50
55	8.8			7.8			7.9			7.3			7.2			55
60	8.8			7.8			7.8			7.2			7.1			60
65	8.7			7.7			7.8			7.2			7.1			65
70	8.7			7.7			7.7			7.2			7.1			70
75	8.6			7.7			7.7			7.2			7.1			75
80	8.5			7.6			7.7			7.1			7.1			80
85	8.2			7.5			7.6			7.1			7			85
90	8			7.3			7.4			7			7			90
95	7.8	6		7.2			7.3			6.9			6.9			95
100	7.5	5.8		7	5.5		7.1	5.6		6.8			6.7			100
105	7.3	5.7		6.8	5.4		6.9	5.5		6.6	5.3		6.6	5.3		105
110	7.1	5.5		6.7	5.3		6.7	5.3		6.5	5.2		6.4	5.2		110
115	6.9	5.4		6.5	5.2		6.6	5.2		6.3	5.1		6.3	5.1		115
120	6.7	5.2		6.3	5		6.4	5.1		6.2	5		6.2	4.9		120
125	6.6	5.1		6.2	4.9		6.3	5		6.1	4.9		6	4.8		125
130	6.4	5	4.1	6	4.8		6.1	4.9		5.9	4.8		5.9	4.7		130
135	6.2	4.9	4	5.9	4.7	3.9	6	4.7	3.9	5.8	4.6	3.8	5.8	4.6		135
140	6	4.8	3.9	5.7	4.6	3.8	5.8	4.6	3.9	5.6	4.5	3.8	5.6	4.5	3.8	140
145	5.9	4.7	3.9	5.6	4.5	3.8	5.7	4.6	3.8	5.5	4.5	3.7	5.5	4.5	3.7	145
150	5.7	4.6	3.8	5.5	4.4	3.7	5.5	4.5	3.7	5.4	4.4	3.7	5.4	4.4	3.7	150
155	5.5	4.5	3.8	5.3	4.3	3.7	5.4	4.4	3.7	5.3	4.3	3.6	5.2	4.3	3.6	155
160	5.4	4.4	3.7	5.2	4.2	3.6	5.3	4.3	3.7	5.2	4.2	3.6	5.1	4.2	3.6	160
165	5.3	4.3	3.7	5.1	4.2	3.6	5.1	4.2	3.6	5	4.1	3.6	5	4.1	3.5	165
170	5.1	4.2	3.6	5	4.1	3.6	5	4.1	3.6	4.9	4.1	3.5	4.9	4	3.5	170
175	5	4.1	3.6	4.8	4	3.5	4.9	4	3.5	4.8	4	3.5	4.8	4	3.5	175
180	4.9	4.1	3.6	4.7	3.9	3.5	4.8	4	3.5	4.7	3.9	3.5	4.7	3.9	3.5	180
185	4.7	4	3.5	4.6	3.9	3.5	4.7	3.9	3.5	4.6	3.8	3.5	4.6	3.9	3.4	185
190	4.6	3.9	3.5	4.5	3.8	3.5	4.6	3.9	3.5	4.5	3.8	3.4	4.5	3.8	3.4	190
195	4.5	3.9	3.5	4.4	3.8	3.5	4.5	3.8	3.5	4.4	3.8	3.4	4.4	3.7	3.4	195
200	4.4	3.8	3.5	4.3	3.7	3.5	4.4	3.7	3.4	4.3	3.7	3.4	4.3	3.7	3.4	200
205	4.3	3.7	3.5	4.3	3.7	3.5	4.3	3.7	3.4	4.2	3.7	3.4	4.2	3.6	3.4	205
210	4.2	3.7	3.5	4.2	3.6	3.5	4.2	3.6	3.4	4.2	3.6	3.4	4.1	3.6	3.4	210
215	4.1	3.6	3.5	4.1	3.6	3.5	4.1	3.6	3.4	4.1	3.6	3.4	4.1	3.6	3.4	215
220	4.1	3.6	3.5	4	3.6	3.5	4	3.6	3.4	4	3.5	3.4	4	3.5	3.4	220
225	4	3.5	3.5	3.9	3.5	3.5	4	3.5	3.4	3.9	3.5	3.4	3.9	3.5	3.4	225
230	3.9	3.5	3.5	3.8	3.5	3.5	3.9	3.5	3.4	3.9	3.5	3.4	3.8	3.5	3.4	230
235	3.8	3.5	3.5	3.8	3.5	3.5	3.8	3.5	3.4	3.8	3.4	3.4	3.8	3.4	3.4	235
240	3.7	3.5	3.5	3.7	3.4	3.5	3.8	3.4	3.4	3.7	3.4	3.4	3.7	3.4	3.4	240
245	3.7	3.5	3.5	3.7	3.4	3.5	3.7	3.4	3.4	3.7	3.4	3.4	3.7	3.4	3.4	245
250	3.6	3.5	3.5	3.6	3.4	3.5	3.6	3.4	3.4	3.6	3.4	3.4	3.6	3.4	3.4	250
255	3.6	3.5	3.5	3.6	3.4	3.5	3.6	3.4	3.4	3.6	3.4	3.4	3.6	3.4	3.4	255
260	3.5	3.5	3.5	3.5	3.4	3.5	3.5	3.4	3.4	3.5	3.4	3.4	3.5	3.4	3.4	260
265	3.5	3.5		3.5	3.4	3.5	3.5	3.4	3.4	3.5	3.4	3.4	3.5	3.4	3.4	265
270	3.4	3.5		3.4	3.4	3.5	3.5	3.4	3.4	3.4	3.4	3.4	3.4	3.4	3.4	270
275	3.4			3.4			3.4	3.4	3.4	3.4	3.4	3.4	3.4	3.4	3.4	275
280				3.3			3.4	3.4		3.4	3.4	3.4	3.4	3.4	3.4	280
285				3.2			3.2			3.4			3.4	3.4		285
290										3.2			3.3			290
295										2.3			2.6			295

t_259_106_16151 / 36151_00_000

Lifting heights

Hauteurs de levage

TVNZK

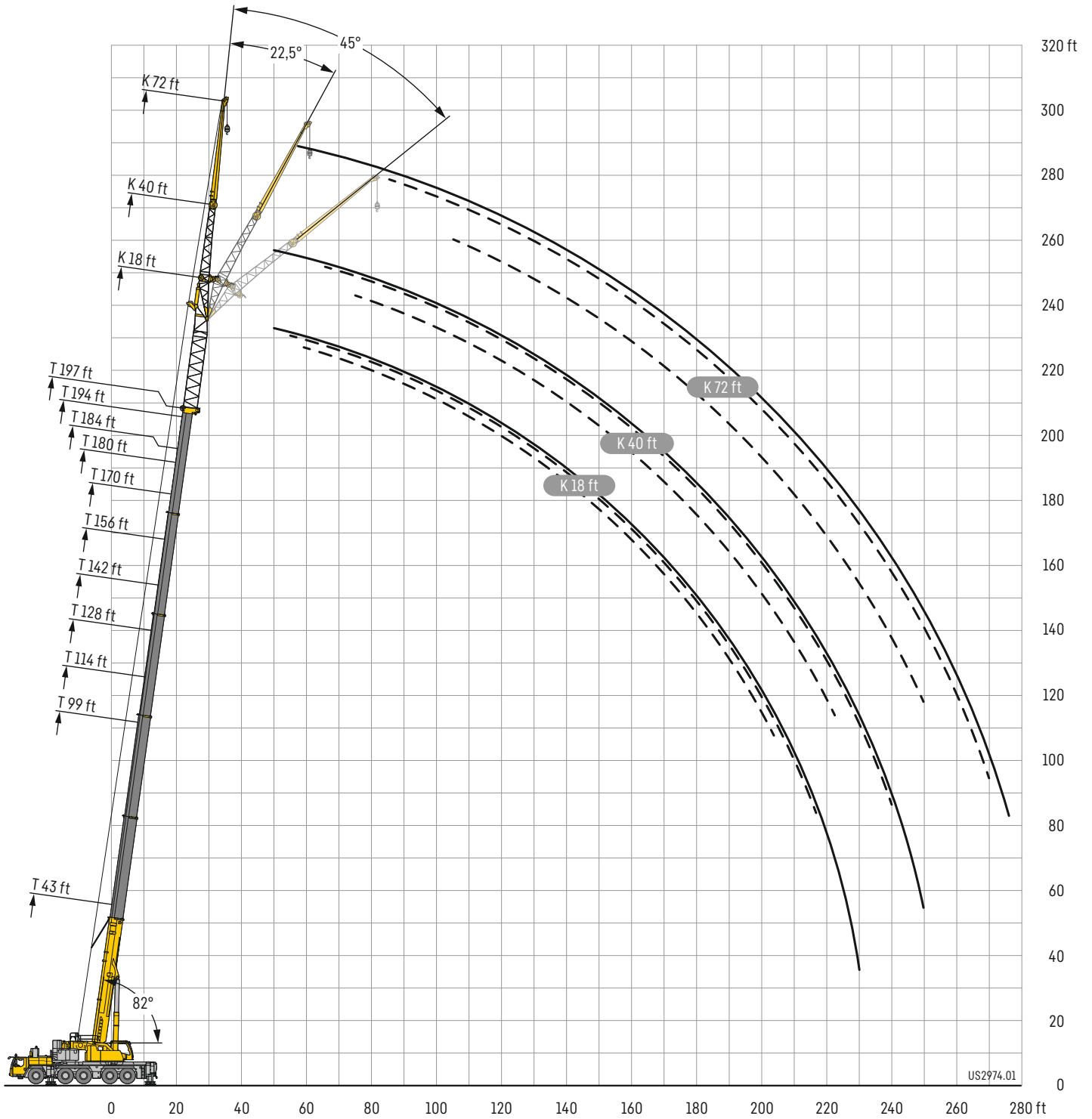

US2974.01

Lifting capacities

Forces de levage

TVNZK

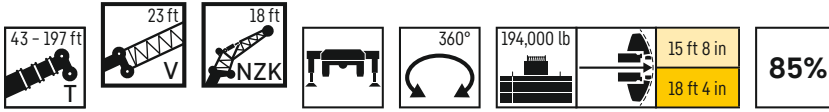

	43 ft + 23 ft			99 ft + 23 ft			114 ft + 23 ft			128 ft + 23 ft			142 ft + 23 ft			156 ft + 23 ft			
	0°	22,5°	45°	0°	22,5°	45°	0°	22,5°	45°	0°	22,5°	45°	0°	22,5°	45°	0°	22,5°	45°	
11	73.3																		11
12	73																		12
13	70.1																		13
14	67.3																		14
15	64.7																		15
16	62.2	63.3																	16
17	59.9	62.9																	17
18	57.9	61.5																	18
19	55.9	60																	19
20	54	58.5	56																20
22	50.5	55.3	54.2	71.9															22
24	47.1	52	51.4	68.5			68.1												24
26	44.2	48.9	48.4	65.3			65.4												26
28	41.4	46.1	45.6	62.4	61.8		62.7			61.3									28
30	38.9	43.6	42.9	59.7	60.1		60.3	59.6		59.1									30
32	36.7	41.2	40.6	57.2	58.3	54.7	58	58		57.1			54.3						32
34	34.7	39	38.5	54.9	56.4	53.2	55.9	56.3	52.3	55.2	53.9		53						34
36	33	37	36.3	52.8	54.5	51.6	53.9	54.6	50.9	53.4	52.7	48.4	51.5			48.2			36
38	31.3	35.1	34.5	50.7	52.6	49.9	52	52.9	49.5	51.8	51.3	47.4	50.1	48.2		47			38
40	29.7	33.5	32.8	48.7	50.7	48.1	50.3	51.3	48	50.2	49.9	46.3	48.7	47.1	43.1	45.9			40
45	26.5	29.8	29	44.1	46.4	44.2	46.2	47.4	44.5	46.6	46.6	43.4	45.6	44.5	41.1	43.3	41.1	37.8	45
50	23.7	26.5	25.9	40.1	42.8	40.7	42.5	43.9	41.4	43.4	43.6	40.7	42.8	42	38.9	41	39.2	36.1	50
55	21.5	23.7	23.2	36.8	39.4	37.6	39.1	40.9	38.6	40.4	40.9	38.2	40.3	39.7	36.8	38.9	37.4	34.6	55
60	19.5	21.3	21	33.9	36.6	34.9	36.2	38.1	36.1	37.6	38.4	35.9	37.9	37.5	34.9	36.9	35.6	33	60
65	17.9	19.2	19	31.5	34	32.4	33.6	35.7	33.7	35.1	36.2	34	35.7	35.5	33.2	35	34	31.5	65
70	16.5	17.5	13	29.2	31.7	30.3	31.4	33.4	31.6	32.8	34.1	32.1	33.5	33.8	31.5	33.2	32.5	30.2	70
75	15.4	16	5.9	27.3	29.6	28.3	29.4	31.5	29.8	30.9	32.2	30.3	31.6	32.1	30	31.5	31.1	28.9	75
80				25.4	27.8	26.6	27.6	29.7	28.1	29.1	30.5	28.7	29.9	30.6	28.6	29.9	29.8	27.7	80
85				24	26	24.9	26	28	26.5	27.5	29	27.3	28.3	29.2	27.3	28.5	28.6	26.5	85
90				22.5	24.3	23.5	24.5	26.5	25.1	26	27.5	25.9	26.9	27.9	26.1	27	27.4	25.5	90
95				21.3	22.9	22.2	23.2	25	23.8	24.7	26.2	24.7	25.5	26.6	24.9	25.9	26.3	24.5	95
100				20.1	21.5	21	22	23.7	22.6	23.4	25	23.5	24.4	25.5	23.8	24.8	25.3	23.6	100
105				19.1	20.3	19.9	20.9	22.4	21.5	22.3	23.8	22.5	23.3	24.4	22.9	23.7	24.3	22.7	105
110				18.1	19.2	18.9	19.9	21.2	20.5	21.3	22.7	21.5	22.3	23.4	22	22.7	23.4	21.8	110
115				17.3	18.3	17.6	19	20.2	19.6	20.4	21.7	20.5	21.4	22.5	21.1	21.9	22.6	21.1	115
120				16.5	17.4	12.7	18.2	19.2	18.7	19.5	20.7	19.7	20.5	21.7	20.3	21	21.8	20.4	120
125				15.8	16.5		17.4	18.3	17.9	18.7	19.8	18.9	19.7	20.8	19.5	20.3	21.1	19.7	125
130				15.2			16.7	17.5	14.5	18	19	18.2	19	20.1	18.8	19.6	20.4	19	130
135							16.1	16.8		17.3	18.2	17.5	18.3	19.3	18.2	18.9	19.7	18.4	135
140							15.5			16.7	17.5	16.2	17.7	18.6	17.6	18.3	19.1	17.8	140
145							15			16.1	16.9	12.6	17.1	17.9	17	17.7	18.6	17.3	145
150										15.6	16.3		16.5	17.3	16.5	17.1	18	16.8	150
155										15.1			16	16.8	13.9	16.7	17.5	16.4	155
160										13.9			15.6	16.2		16.2	17	15.9	160
165													15.1	15.8		15.8	16.2	15.4	165
170													14.7			15	15.6	12.6	170
175													13.1			14.7	15.2		175
180																14.4			180
185																13.2			185
190																8.6			190

t 259_107_10151 / 30151_00_000

Lifting capacities

Forces de levage

TVNZK

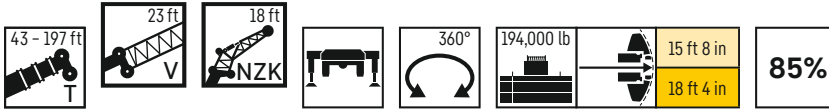

	170 ft + 23 ft			180 ft + 23 ft			184 ft + 23 ft			194 ft + 23 ft			197 ft + 23 ft			
	0°	22,5°	45°	0°	22,5°	45°	0°	22,5°	45°	0°	22,5°	45°	0°	22,5°	45°	
40	40.4															40
45	38.9	36.2		33.2			34.1									45
50	37.1	35	32.3	32.6	30.4		33.4	30.8		29.9			29.3			50
55	35.5	33.7	31.1	31.7	29.5	27.3	32.4	29.9	27.7	29.4	27.6		28.9	27.1		55
60	34	32.5	30	30.6	28.6	26.5	31.2	29	26.9	28.9	26.9	24.9	28.4	26.5	24.5	60
65	32.6	31.2	28.9	29.3	27.7	25.7	30.1	28.2	26	28.3	26.2	24.2	27.9	25.9	23.9	65
70	31.1	30.1	27.8	28.1	26.8	24.9	28.9	27.3	25.3	27.4	25.5	23.6	27.2	25.2	23.3	70
75	29.7	29	26.8	27	26	24.1	27.7	26.5	24.5	26.4	24.8	23	26.3	24.6	22.7	75
80	28.4	27.9	25.9	25.9	25.2	23.4	26.6	25.7	23.8	25.5	24.2	22.4	25.4	23.9	22.1	80
85	27.2	26.9	25	25	24.4	22.7	25.6	24.9	23.1	24.6	23.5	21.8	24.5	23.3	21.6	85
90	26	26	24.1	24.1	23.7	22.1	24.7	24.2	22.4	23.8	22.9	21.2	23.7	22.7	21	90
95	25	25.1	23.3	23.2	23	21.4	23.8	23.5	21.7	23	22.3	20.7	22.9	22.2	20.5	95
100	24	24.2	22.5	22.5	22.3	20.8	23	22.8	21.1	22.3	21.8	20.1	22.2	21.6	20	100
105	23.1	23.4	21.8	21.7	21.7	20.2	22.2	22.1	20.5	21.6	21.2	19.6	21.5	21.1	19.5	105
110	22.3	22.7	21.1	21	21.1	19.7	21.5	21.5	20	21	20.7	19.1	20.9	20.6	19	110
115	21.5	22	20.4	20.4	20.4	19.1	20.8	20.9	19.4	20.3	20.2	18.7	20.3	20.1	18.5	115
120	20.8	21.3	19.8	19.7	19.8	18.6	20.2	20.4	18.9	19.7	19.6	18.2	19.7	19.6	18.1	120
125	20.1	20.6	19.2	19.1	19.1	18.1	19.6	19.8	18.4	19.1	19.1	17.8	19.1	19	17.7	125
130	19.4	20.1	18.7	18.4	18.4	17.7	19	19.3	17.9	18.5	18.4	17.4	18.5	18.4	17.3	130
135	18.8	19.5	18.1	17.7	17.7	17.2	18.5	18.8	17.5	17.9	17.8	17	17.9	17.8	16.9	135
140	18.3	18.9	17.6	17	17	16.8	18	18.4	17.1	17.3	17.2	16.6	17.2	17.2	16.5	140
145	17.7	18.5	17.2	16.3	16.3	16.3	17.5	17.9	16.7	16.7	16.7	16.2	16.6	16.7	16.2	145
150	17.2	18	16.7	15.7	15.7	15.8	17.1	17.5	16.3	16	16.1	15.9	16.1	16.1	15.8	150
155	16.8	17.5	16.3	15.1	15.1	15.2	16.6	17.1	15.9	15.5	15.5	15.5	15.5	15.5	15.5	155
160	16.3	17.1	15.9	14.5	14.5	14.6	16.2	16.8	15.6	14.9	15	15	15	15	15.1	160
165	15.9	16.6	15.5	14	14	14.1	15.9	16.3	15.3	14.4	14.5	14.5	14.5	14.5	14.6	165
170	15.3	15.6	15.2	13.5	13.5	13.6	15.5	15.9	14.9	13.9	14	14	14	14	14.1	170
175	14.9	15	14.6	13	13	13.1	14.9	15	14.7	13.5	13.5	13.6	13.5	13.5	13.6	175
180	14.5	14.5	13.3	12.5	12.6	12.7	13.9	14.1	14.1	13	13.1	13.2	13	13	13.1	180
185	14.1	14.1		12.1	12.1	12.2	13	13.2	13.2	12.6	12.6	12.7	12.5	12.5	12.6	185
190	13.3	13.4		11.7	11.7	11.8	12.2	12.3	12.3	12.1	12.2	12.3	11.9	12.1	12.1	190
195	12.4			11.3	11.3		11.4	11.5	11.5	11.4	11.6	11.5	11.2	11.4	11.4	195
200	9.8			10.9	10.9		10.7	10.8		10.7	10.8	10.8	10.5	10.6	10.6	200
205	4.7			10.5			10	10.1		10	10.1		9.8	9.9	9.9	205
210				8.2			8.9			9.3	9.4		9.1	9.2		210
215				3.4			6.3			8.7			8.5	8.6		215
220										7.5			7.8			220
225										5.2			6			225
230													3			230

t_259_107_10151 / 30151_00_000

Lifting capacities

Forces de levage

TVNZK

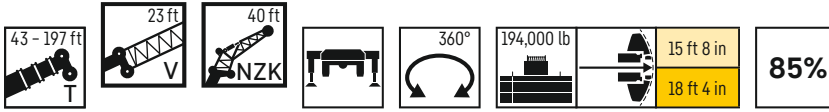

	43 ft + 23 ft			99 ft + 23 ft			114 ft + 23 ft			128 ft + 23 ft			142 ft + 23 ft			156 ft + 23 ft			
	0°	22,5°	45°	0°	22,5°	45°	0°	22,5°	45°	0°	22,5°	45°	0°	22,5°	45°	0°	22,5°	45°	
11	46.1																		11
12	46.1																		12
13	46.1																		13
14	46.1																		14
15	46.1																		15
16	46.1																		16
17	46.1																		17
18	46.1																		18
19	46.1																		19
20	45.9																		20
22	44.6			46.1															22
24	42.7			46.1			46.1												24
26	40.9	38.2		46.1			46.1												26
28	39.2	37.7		46.1			46.1			45.4									28
30	37.5	36.4		46.1			46.1			44.9									30
32	36.1	35.1		46.1			46			44.2			40.5						32
34	34.6	33.9		45.6			45.4			43.5			40.1						34
36	33.2	32.8		44.7			44.5			42.7			39.5			35.3			36
38	32	31.8	27.4	43.5	37.8		43.4			41.8			39			35			38
40	30.7	30.8	26.9	42.3	37		42.3	36.6		40.9			38.3			34.6			40
45	28.1	28.6	25.9	39.4	34.9		39.7	34.9		38.7	34		36.6			33.5			45
50	25.7	26.6	24.9	36.8	33.1	27.1	37.3	33.3		36.7	32.6		35	31.4		32.3			50
55	23.7	24.9	23.7	34.4	31.4	26.4	35.1	31.7	26.6	34.7	31.3	26.6	33.4	30.3		31.1	28.5		55
60	21.9	23.3	22.4	32.3	29.9	25.8	33.1	30.3	26	32.9	30	26	31.9	29.2	25.6	29.9	27.6		60
65	20.3	22	21	30.3	28.6	25.2	31.3	28.9	25.5	31.3	28.8	25.4	30.4	28.1	24.9	28.7	26.8	23.9	65
70	18.9	20.6	19.3	28.6	27.3	24.6	29.5	27.8	24.8	29.7	27.7	24.7	29.1	27.1	24.2	27.6	26	23.1	70
75	17.6	18.9	17.6	27	26.1	23.8	28	26.7	24	28.3	26.7	23.9	27.8	26.2	23.5	26.6	25.2	22.3	75
80	16.5	17.5	16.1	25.5	25	23	26.6	25.6	23.3	26.9	25.7	23.3	26.6	25.4	22.9	25.6	24.5	21.6	80
85	15.6	16.2	14.7	24.2	24	22.3	25.3	24.6	22.6	25.7	24.8	22.6	25.5	24.5	22.1	24.6	23.8	20.8	85
90	14.7	15	13.4	22.9	23.1	21.4	24	23.8	21.9	24.6	24	21.9	24.5	23.8	21.3	23.7	23.1	20.1	90
95	13.9	14	5.3	21.8	22.2	20.5	22.9	23	21.1	23.5	23.2	21	23.5	23.1	20.5	22.9	22.4	19.4	95
100	13.4			20.7	21.4	19.5	21.9	22.1	20.1	22.5	22.4	20.1	22.6	22.4	19.7	22.1	21.7	18.8	100
105				19.8	20.5	18.5	20.9	21.3	19.1	21.6	21.7	19.2	21.7	21.7	18.9	21.3	21	18.1	105
110				18.9	19.5	17.5	20	20.4	18.2	20.7	20.9	18.4	20.9	20.9	18.2	20.6	20.3	17.5	110
115				18.1	18.5	16.6	19.2	19.6	17.4	19.9	20.1	17.6	20.2	20.1	17.5	19.9	19.6	16.9	115
120				17.3	17.7	15.8	18.4	18.7	16.6	19.1	19.3	16.9	19.4	19.3	16.9	19.3	19	16.4	120
125				16.6	16.9	15	17.7	17.9	15.8	18.4	18.5	16.2	18.8	18.7	16.2	18.7	18.4	15.8	125
130				15.9	16.1	14.3	17	17.2	15.2	17.8	17.8	15.6	18.1	18	15.7	18.1	17.8	15.3	130
135				15.3	15.4		16.4	16.4	14.5	17.1	17.1	15	17.5	17.4	15.1	17.5	17.2	14.8	135
140				14.8	14.7		15.8	15.8	13.9	16.6	16.5	14.4	17	16.8	14.6	17	16.7	14.4	140
145				14.3	14.1		15.2	15.2	13.1	16	15.9	13.8	16.5	16.2	14.1	16.5	16.2	13.9	145
150				13.8	13.5		14.8	14.5		15.5	15.3	13.3	16	15.7	13.6	16.1	15.7	13.5	150
155				13.5			14.3	14		15	14.7	12.8	15.5	15.2	13.1	15.6	15.2	13.1	155
160							13.9	13.5		14.6	14.3	11.1	15.1	14.7	12.7	15.2	14.8	12.7	160
165							13.5	13.1		14.2	13.8		14.7	14.3	12.3	14.8	14.4	12.3	165
170							11.4			13.8	13.4		14.3	13.8	11.7	14.5	14	12	170
175										13.5	13		13.9	13.4		14.1	13.6	11.6	175
180										12.3	12.7		13.6	13.1		13.6	13.3	11.3	180
185										9.2			13.2	12.8		13.3	13	10.3	185
190													12.8	12.5		13.1	12.5		190
195													10.2			12.5	12.3		195
200																11.8	12		200
205																10.2	11.2		205
210																8.2			210

t.259_107_11151 / 31151_00_000

Lifting capacities

Forces de levage

TVNZK

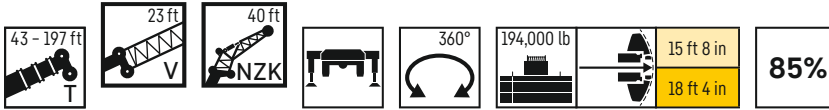

	170 ft + 23 ft			180 ft + 23 ft			184 ft + 23 ft			194 ft + 23 ft			197 ft + 23 ft			
	40 ft															
	0°	22,5°	45°	0°	22,5°	45°	0°	22,5°	45°	0°	22,5°	45°	0°	22,5°	45°	
40	30.2															40
45	29.6			24.9			25.3			21						45
50	28.8			24.5			24.9			20.8			20.5			50
55	28			24			24.4			20.5			20.2			55
60	27.2	25.5		23.5			23.9			20.1			19.8			60
65	26.3	24.8		22.9	21.7		23.3	22.1		19.7	19.2		19.4	18.9		65
70	25.4	24.2	20.9	22.3	21.2		22.7	21.6		19.2	18.9		19	18.6		70
75	24.6	23.6	20.3	21.7	20.8	17.9	22.1	21.1	18.1	18.8	18.5	15.9	18.6	18.3	15.7	75
80	23.8	23.1	19.7	21.2	20.3	17.5	21.6	20.6	17.6	18.4	18.1	15.6	18.2	17.9	15.4	80
85	23.1	22.3	19.1	20.6	19.7	17	21	20.1	17.2	18	17.8	15.3	17.8	17.6	15.1	85
90	22.4	21.7	18.6	20.1	19	16.6	20.5	19.6	16.8	17.6	17.4	14.9	17.4	17.2	14.8	90
95	21.7	21	18	19.5	18.5	16.2	19.9	19.1	16.4	17.2	17	14.6	17	16.8	14.4	95
100	21	20.4	17.5	19	17.9	15.8	19.4	18.6	15.9	16.8	16.7	14.3	16.6	16.5	14.1	100
105	20.4	19.8	16.9	18.5	17.4	15.4	18.9	18.1	15.5	16.4	16.3	14	16.3	16.1	13.8	105
110	19.8	19.2	16.5	18	17	15	18.4	17.6	15.1	16	16	13.7	15.9	15.8	13.5	110
115	19.2	18.6	16	17.5	16.5	14.6	17.9	17.1	14.8	15.7	15.6	13.4	15.6	15.5	13.2	115
120	18.6	18.1	15.5	17	16	14.2	17.5	16.7	14.4	15.4	15.3	13.1	15.3	15.1	12.9	120
125	18.1	17.6	15.1	16.4	15.6	13.9	17.1	16.2	14	15	14.9	12.8	14.9	14.8	12.7	125
130	17.6	17.1	14.6	15.9	15.2	13.6	16.7	15.8	13.7	14.7	14.6	12.5	14.6	14.5	12.4	130
135	17.1	16.6	14.2	15.4	14.7	13.2	16.3	15.5	13.4	14.4	14.3	12.2	14.3	14.2	12.1	135
140	16.7	16.2	13.8	14.8	14.3	12.9	15.9	15.1	13	14.1	13.9	12	14	13.8	11.9	140
145	16.2	15.7	13.5	14.3	13.9	12.6	15.4	14.8	12.7	13.8	13.6	11.7	13.7	13.5	11.6	145
150	15.8	15.3	13.1	13.8	13.5	12.3	15	14.4	12.4	13.5	13.2	11.5	13.4	13.2	11.4	150
155	15.4	14.9	12.7	13.3	13.1	12	14.6	14.1	12.1	13.1	12.9	11.2	13.1	12.8	11.2	155
160	15.1	14.5	12.4	12.8	12.8	11.7	14.2	13.7	11.9	12.7	12.5	11	12.7	12.5	10.9	160
165	14.7	14.2	12.1	12.3	12.4	11.5	13.8	13.4	11.6	12.4	12.2	10.8	12.3	12.2	10.7	165
170	14.4	13.9	11.8	11.9	12	11.2	13.4	13.1	11.3	12	11.9	10.6	12	11.9	10.5	170
175	14.1	13.5	11.5	11.4	11.5	11	13.1	12.8	11.1	11.6	11.6	10.4	11.6	11.6	10.3	175
180	13.7	13.2	11.2	11	11.1	10.8	12.7	12.5	10.9	11.2	11.3	10.2	11.2	11.3	10.2	180
185	12.9	12.9	11	10.6	10.7	10.6	12.3	12.2	10.7	10.8	10.9	10	10.8	10.9	10	185
190	12.1	12.6	10.7	10.2	10.3	10.4	12	11.9	10.5	10.5	10.5	9.8	10.5	10.6	9.8	190
195	11.3	11.8	10.5	9.8	9.9	10.1	11.6	11.6	10.3	10.1	10.2	9.7	10.1	10.2	9.6	195
200	11	11.1		9.5	9.6	9.8	10.9	11.3	10.1	9.8	9.9	9.5	9.8	9.9	9.5	200
205	10.6	10.8		9.2	9.3	9.4	10.2	10.6	9.9	9.5	9.5	9.4	9.5	9.6	9.3	205
210	10.4	10.5		8.9	8.9	8.2	9.5	9.9	9.4	9.2	9.2	9.2	9.2	9.3	9.2	210
215	10	10.3		8.6	8.7		8.9	9.3	7.7	8.8	9	9.1	8.8	9	9	215
220	8	9.1		8.3	8.4		8.3	8.6		8.4	8.7	8.8	8.2	8.6	8.7	220
225	5.3			8	8.1		7.8	8		7.8	8.2		7.7	8	7.9	225
230				6.8			7	7.5		7.3	7.6		7.2	7.5		230
235				4.3			5.2			6.9	7.1		6.8	7		235
240							2.3			6.1	6.7		6.3	6.5		240
245										4.4			4.9			245
250													2.7			250

t_259_107_11151 / 31151_00_000

Lifting capacities

Forces de levage

TVNZK

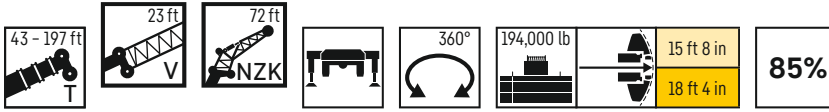

	43 ft + 23 ft			99 ft + 23 ft			114 ft + 23 ft			128 ft + 23 ft			142 ft + 23 ft			156 ft + 23 ft			
	0°	22,5°	45°	0°	22,5°	45°	0°	22,5°	45°	0°	22,5°	45°	0°	22,5°	45°	0°	22,5°	45°	
16	19.2																		16
17	19.2																		17
18	19.2																		18
19	19.2																		19
20	19.2																		20
22	19.2																		22
24	19.2																		24
26	19.1			19.2															26
28	19			19.2			18.7												28
30	18.8			19.2			18.7												30
32	18.6			19.2			18.7			18									32
34	18.4			19.2			18.7			18									34
36	18.2			19.2			18.7			18			17.1						36
38	17.9			19.1			18.6			17.9			17.1			15.9			38
40	17.7			19.1			18.6			17.9			17			15.9			40
45	17.1	15.3		18.8			18.5			17.8			16.9			15.8			45
50	16.5	14.7		18.4			18.2			17.7			16.8			15.7			50
55	15.9	14		18	15.3		17.8			17.4			16.7			15.7			55
60	15.3	13.5		17.6	14.9		17.4	14.9		17.1			16.6			15.6			60
65	14.7	13	11.1	17.1	14.4		17.1	14.5		16.8	14.3		16.3	14.1		15.5			65
70	14.1	12.5	10.8	16.7	14		16.7	14		16.4	14		16	13.7		15.3	13.4		70
75	13.5	12	10.6	16.3	13.6	11.1	16.3	13.7		16.1	13.6		15.7	13.4		15	13.1		75
80	13	11.6	10.3	15.9	13.3	10.9	15.9	13.3	10.9	15.7	13.3	10.8	15.4	13.1		14.8	12.8		80
85	12.4	11.3	10.1	15.4	12.9	10.7	15.5	13	10.7	15.4	13	10.7	15.1	12.8	10.6	14.5	12.6		85
90	11.9	10.9	10	15	12.6	10.6	15.1	12.7	10.6	15.1	12.7	10.5	14.8	12.5	10.5	14.3	12.3	10.3	90
95	11.5	10.6	9.9	14.6	12.3	10.4	14.8	12.4	10.4	14.7	12.4	10.4	14.5	12.3	10.3	14	12.1	10.2	95
100	11.1	10.4	9.8	14.2	12	10.3	14.4	12.1	10.3	14.4	12.1	10.3	14.2	12	10.2	13.8	11.8	10.1	100
105	10.7	10.2	9.8	13.8	11.7	10.2	14	11.8	10.2	14.1	11.9	10.2	13.9	11.8	10.1	13.5	11.6	10	105
110	10.3	10	9.8	13.3	11.4	10.1	13.6	11.6	10.1	13.7	11.6	10.1	13.6	11.6	10	13.2	11.4	9.9	110
115	9.9	9.9	9.8	13	11.2	10	13.3	11.3	10	13.4	11.4	10	13.3	11.4	9.9	13	11.2	9.8	115
120	9.6	9.8	9.8	12.6	11	9.9	12.9	11.1	9.9	13.1	11.2	9.9	13	11.2	9.8	12.7	11	9.7	120
125	9.2	9.7		12.2	10.8	9.9	12.6	10.9	9.9	12.8	11	9.8	12.7	11	9.8	12.4	10.9	9.7	125
130	9	9.5		11.9	10.6	9.8	12.3	10.7	9.8	12.4	10.8	9.8	12.5	10.8	9.7	12.2	10.7	9.6	130
135				11.6	10.4	9.8	11.9	10.6	9.8	12.1	10.6	9.7	12.2	10.6	9.7	11.9	10.6	9.6	135
140				11.3	10.2	9.8	11.6	10.4	9.8	11.8	10.5	9.7	11.9	10.5	9.6	11.7	10.4	9.6	140
145				11	10.1	9.8	11.4	10.3	9.8	11.6	10.3	9.7	11.7	10.3	9.6	11.4	10.3	9.5	145
150				10.7	10	9.8	11.1	10.1	9.8	11.3	10.2	9.7	11.4	10.2	9.6	11.2	10.1	9.5	150
155				10.5	9.9	9.8	10.8	10	9.8	11	10.1	9.7	11.2	10.1	9.6	10.9	10	9.5	155
160				10.2	9.9	9.8	10.6	9.9	9.8	10.8	10	9.7	10.9	10	9.6	10.7	9.9	9.5	160
165				9.9	9.8	9.8	10.3	9.9	9.8	10.6	9.9	9.7	10.7	9.9	9.6	10.5	9.8	9.5	165
170				9.6	9.8		10	9.8	9.8	10.3	9.8	9.7	10.5	9.8	9.6	10.3	9.7	9.5	170
175				9.4	9.7		9.8	9.8	9.7	10.1	9.7	9.7	10.2	9.7	9.6	10.1	9.6	9.4	175
180				9.2	9.5		9.5	9.7	9.3	9.8	9.7	9.6	10	9.7	9.5	9.9	9.6	9.3	180
185				9	9.5		9.3	9.5		9.6	9.6	9.3	9.8	9.6	9.3	9.7	9.5	9.1	185
190							9.1	9.4		9.4	9.5		9.5	9.6	9	9.5	9.5	8.8	190
195							9	9.4		9.2	9.4		9.3	9.4	8.7	9.3	9.4	8.6	195
200							8.9			9	9.3		9.2	9.3	8.5	9.2	9.3	8.4	200
205										8.9	9.2		9	9.2		9	9.2	8.2	205
210										8.8	9.2		8.8	9.1		8.9	9.1	7.9	210
215										7.1			8.7	9.1		8.7	9	7.7	215
220													8.6	9.1		8.6	8.9		220
225													7.6			8.4	8.9		225
230													6.1			8.3	8.8		230
235																7.8	8.7		235
240																6.7			240
245																3.3			245

t_259_107_13151 / 33151_00_000

Lifting capacities

Forces de levage

TVNZK

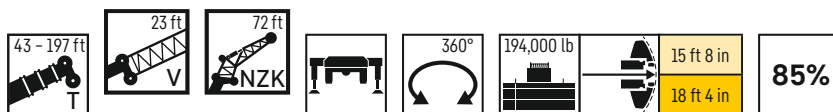

	170 ft + 23 ft			180 ft + 23 ft			184 ft + 23 ft			194 ft + 23 ft			197 ft + 23 ft			
	72 ft															
	0°	22,5°	45°	0°	22,5°	45°	0°	22,5°	45°	0°	22,5°	45°	0°	22,5°	45°	
45	14.4															45
50	14.4			12.6			12.8			11.8						50
55	14.3			12.6			12.7			11.7			11.6			55
60	14.3			12.6			12.7			11.7			11.5			60
65	14.2			12.5			12.7			11.7			11.5			65
70	14.2			12.5			12.6			11.7			11.5			70
75	14.1	12.6		12.5			12.6			11.6			11.5			75
80	13.9	12.3		12.4	11.5		12.5	11.6		11.6			11.4			80
85	13.7	12.1		12.3	11.4		12.4	11.5		11.6	10.9		11.4	10.9		85
90	13.4	11.9		12	11.2		12.2	11.3		11.4	10.8		11.3	10.8		90
95	13.2	11.7	10	11.9	11		12	11.1		11.3	10.7		11.1	10.6		95
100	12.9	11.5	9.9	11.7	10.9	9.6	11.8	11	9.6	11.1	10.6		11	10.5		100
105	12.7	11.3	9.8	11.5	10.7	9.5	11.6	10.8	9.6	10.9	10.4	9.4	10.8	10.4	9.3	105
110	12.4	11.1	9.7	11.3	10.6	9.5	11.4	10.7	9.5	10.7	10.3	9.3	10.7	10.2	9.3	110
115	12.2	10.9	9.7	11.1	10.4	9.4	11.2	10.5	9.4	10.6	10.2	9.3	10.5	10.1	9.2	115
120	12	10.8	9.6	10.9	10.3	9.4	11	10.4	9.4	10.4	10.1	9.2	10.3	10	9.2	120
125	11.8	10.6	9.6	10.7	10.2	9.3	10.9	10.2	9.4	10.3	10	9.2	10.2	9.9	9.1	125
130	11.5	10.5	9.5	10.5	10	9.3	10.7	10.1	9.3	10.1	9.8	9.1	10	9.8	9	130
135	11.3	10.3	9.4	10.4	9.9	9.3	10.5	10	9.3	10	9.7	9	9.9	9.7	8.9	135
140	11.1	10.2	9.4	10.2	9.7	9.2	10.3	9.9	9.2	9.8	9.5	8.9	9.7	9.5	8.7	140
145	10.9	10.1	9.4	10	9.5	9	10.2	9.7	9.2	9.7	9.4	8.7	9.6	9.3	8.6	145
150	10.7	10	9.4	9.8	9.3	8.9	10	9.5	9.1	9.5	9.2	8.6	9.4	9.2	8.5	150
155	10.5	9.9	9.4	9.7	9.1	8.7	9.8	9.4	9	9.4	9	8.4	9.3	9	8.3	155
160	10.3	9.8	9.3	9.5	8.9	8.5	9.6	9.2	8.8	9.2	8.8	8.3	9.2	8.8	8.2	160
165	10.1	9.7	9.2	9.3	8.7	8.4	9.5	9	8.6	9.1	8.6	8.1	9	8.6	8	165
170	9.9	9.6	9.1	9.2	8.4	8.3	9.3	8.8	8.5	8.9	8.5	8	8.9	8.5	7.9	170
175	9.8	9.5	9	9	8.2	8.1	9.2	8.6	8.3	8.8	8.3	7.8	8.7	8.3	7.8	175
180	9.6	9.5	8.8	8.8	8.1	8	9	8.4	8.2	8.7	8.1	7.7	8.6	8.1	7.6	180
185	9.4	9.4	8.6	8.6	7.9	7.9	8.9	8.3	8	8.5	8	7.6	8.5	8	7.5	185
190	9.3	9.3	8.4	8.4	7.8	7.7	8.7	8.1	7.8	8.4	7.8	7.4	8.4	7.8	7.4	190
195	9.1	9.2	8.2	8.1	7.7	7.6	8.5	8	7.7	8.2	7.7	7.3	8.2	7.7	7.2	195
200	9	9.1	8	7.9	7.5	7.5	8.4	7.8	7.5	8.1	7.6	7.2	8.1	7.6	7.1	200
205	8.8	9	7.9	7.8	7.4	7.3	8.2	7.7	7.4	7.9	7.5	7.1	7.9	7.5	7	205
210	8.7	8.9	7.7	7.6	7.3	7.2	8	7.6	7.3	7.7	7.4	7	7.7	7.4	6.9	210
215	8.6	8.8	7.5	7.3	7.2	7.1	7.9	7.5	7.2	7.5	7.3	6.9	7.5	7.3	6.8	215
220	8.5	8.7	7.4	7.1	7.1	7	7.7	7.4	7.1	7.3	7.2	6.8	7.3	7.2	6.8	220
225	8.4	8.7	7.3	6.9	7	6.9	7.6	7.3	6.9	7.1	7.1	6.7	7.1	7.1	6.7	225
230	7.8	8.4	7.1	6.7	6.9	6.8	7.5	7.2	6.8	6.9	7	6.6	6.9	7	6.6	230
235	7.4	7.9		6.5	6.7	6.8	7.3	7.2	6.8	6.7	6.9	6.5	6.8	6.9	6.5	235
240	7.1	7.3		6.3	6.5		7.1	7.2	6.7	6.5	6.7	6.5	6.6	6.7	6.4	240
245	7	7.2		6.2	6.3		6.7	7	6.6	6.4	6.5	6.4	6.4	6.6	6.4	245
250	6.3			6	6.1		6.3	6.7		6.1	6.4	6.4	6	6.4	6.3	250
255	4.4			5.8	6		5.9	6.3		5.8	6.2		5.7	6.1		255
260				5.3			5.2	5.8		5.4	5.8		5.3	5.7		260
265				3.4			3.9	5		5.1	5.4		5	5.3		265
270										4.4	5		4.5	4.9		270
275										2.9			3.3			275

t_259_107_13151 / 33151.00.00

Lifting heights

Hauteurs de levage

TVNZK

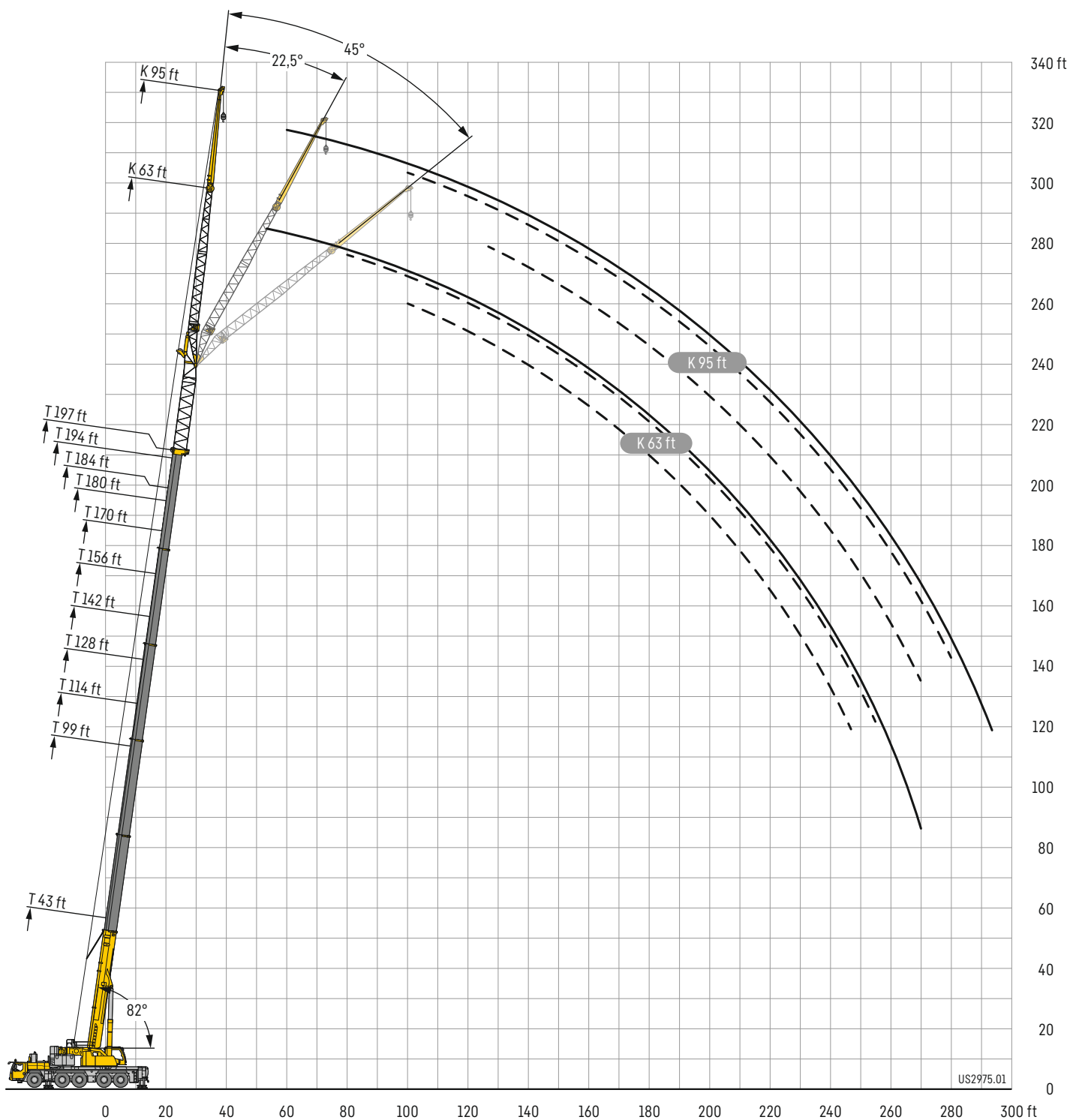

Lifting capacities

Forces de levage

TVNZK

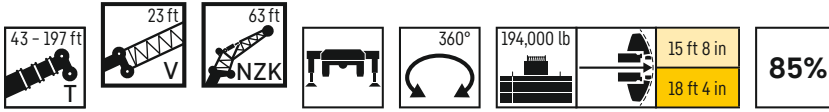

	43 ft + 23 ft			99 ft + 23 ft			114 ft + 23 ft			128 ft + 23 ft			142 ft + 23 ft			156 ft + 23 ft			
	0°	22,5°	45°	0°	22,5°	45°	0°	22,5°	45°	0°	22,5°	45°	0°	22,5°	45°	0°	22,5°	45°	
16	32.4																		16
17	32.4																		17
18	32.4																		18
19	32.4																		19
20	32.4																		20
22	32.1																		22
24	31.7																		24
26	31.1			32.4															26
28	30.6			32.4															28
30	29.9			32.4			30.8												30
32	29.2			32.3			30.8		28.7										32
34	28.3			32.1			30.8		28.6										34
36	27.5			31.8			30.6		28.6		26.1								36
38	26.6			31.4			30.3		28.5		26.1				22.5				38
40	25.9	22.3		31			30		28.3		26				22.4				40
45	24	21.1		30			29.2		27.6		25.7				22.3				45
50	22.3	19.9		28.6			28.2		26.9		25.1				22.1				50
55	20.8	18.9		27.1	21.5		27.1	21.5	26.2		24.6				22				55
60	19.4	17.9	14.8	25.8	20.7		25.9	20.7	25.2	20.4	24				21.7				60
65	18.1	17	14.4	24.4	19.9		24.7	19.9	24.2	19.8	23.2	19.3			21.1	18.7			65
70	17	16.1	14	23.2	19.2	15	23.5	19.3	14.9	23.3	19.1			22.4	18.8		20.5	18.3	70
75	16	15.3	13.6	22.1	18.5	14.6	22.5	18.7	14.6	22.3	18.6	14.5		21.6	18.2		19.9	17.8	75
80	15.1	14.6	13.2	21	17.9	14.3	21.5	18.1	14.3	21.4	18	14.5	20.8	17.7	14.1	19.3	17.3		80
85	14.2	13.9	12.8	20.1	17.2	14.1	20.5	17.5	14.1	20.5	17.4	14	20.1	17.2	14	18.7	16.8	14.7	85
90	13.4	13.3	12.5	19.1	16.6	13.8	19.7	16.9	13.8	19.7	16.9	13.8	19.3	16.7	13.7	18.2	16.4	14.5	90
95	12.8	12.7	12.3	18.2	16	13.6	18.8	16.3	13.6	18.9	16.4	13.6	18.7	16.2	13.5	17.6	15.9	14.3	95
100	12.1	12.1	12.1	17.5	15.5	13.3	18	15.8	13.4	18.2	15.9	13.4	18	15.8	13.3	17.1	15.5	14	100
105	11.6	11.6	11.8	16.7	15	13.1	17.3	15.3	13.2	17.5	15.4	13.2	17.4	15.3	13.1	16.6	15.2	13.7	105
110	11	11.1	10.9	16	14.6	12.9	16.6	14.9	13	16.9	15	13	16.8	14.9	12.9	16.1	14.8	13.5	110
115	10.6	10.8	7.1	15.3	14.1	12.7	16	14.5	12.8	16.2	14.6	12.8	16.2	14.6	12.7	15.6	14.4	13.2	115
120	10.2	10.5		14.7	13.7	12.5	15.4	14	12.6	15.7	14.2	12.6	15.7	14.2	12.5	15.2	14	13	120
125				14.2	13.3	12.4	14.8	13.7	12.4	15.1	13.8	12.4	15.2	13.8	12.4	14.7	13.7	12.8	125
130				13.6	12.9	12.2	14.3	13.3	12.3	14.6	13.5	12.3	14.7	13.5	12.2	14.3	13.4	12.5	130
135				13.1	12.5	12.2	13.8	12.9	12.2	14.1	13.1	12.2	14.3	13.2	12.1	13.9	13.1	12.1	135
140				12.7	12.2	12	13.3	12.6	12	13.7	12.8	12.1	13.8	12.9	12	13.6	12.8	11.8	140
145				12.2	11.8	11.8	12.8	12.2	12	13.2	12.5	12	13.4	12.6	11.9	13.2	12.5	11.5	145
150				11.8	11.5	11.4	12.4	11.9	11.8	12.8	12.2	11.8	13	12.3	11.6	12.8	12.3	11.2	150
155				11.4	11.2	10.8	12	11.6	11.4	12.4	11.9	11.5	12.7	12	11.3	12.5	12.1	10.8	155
160				11.1	10.9		11.7	11.3	10.9	12.1	11.6	11.1	12.3	11.7	11	12.2	11.8	10.5	160
165				10.8	10.7		11.3	11.1	10.5	11.8	11.3	10.7	12	11.5	10.7	11.9	11.6	10.2	165
170				10.5	10.6		11	10.8		11.4	11.1	10.3	11.7	11.2	10.3	11.6	11.4	9.9	170
175				10.2	10.5		10.7	10.6		11.1	10.8	10	11.4	11	10	11.3	11.2	9.7	175
180				8.8			10.5	10.5		10.9	10.6	9.6	11.1	10.7	9.7	11.1	11	9.4	180
185							10.2	10.4		10.6	10.4		10.8	10.6	9.4	10.9	10.9	9.2	185
190							10	10.4		10.4	10.3		10.6	10.4	9.1	10.6	10.7	8.9	190
195										10.2	10.2		10.4	10.3		10.4	10.6	8.6	195
200										10	10.2		10.2	10.1		10.2	10.4	8.4	200
205										7.6			10	10.1		10	10.3	8.2	205
210													9.8	10		9.7	10.2	8	210
215													8.6	10		9.6	9.9		215
220													7.4			9.4	9.7		220
225																8.7	9.4		225
230																7.5	8		230
235																4.7			235

t.259_107_12151 / 32151_00_000

Lifting capacities

Forces de levage

TVNZK

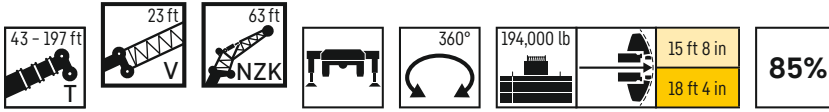

	170 ft + 23 ft			180 ft + 23 ft			184 ft + 23 ft			194 ft + 23 ft			197 ft + 23 ft			
	0°	22,5°	45°	0°	22,5°	45°	0°	22,5°	45°	0°	22,5°	45°	0°	22,5°	45°	
45	19.5															45
50	19.4			16.3			16.5			14.9						50
55	19.3			16.3			16.5			14.9			14.6			55
60	19.2			16.2			16.5			14.8			14.5			60
65	19			16.2			16.4			14.8			14.5			65
70	18.5	16.9		16			16.3			14.8			14.5			70
75	18.1	16.5		15.7	14.7		16			14.7			14.4			75
80	17.7	16.2		15.4	14.4		15.6	14.6		14.4	13.4		14.2	13.1		80
85	17.2	15.8		15.1	14.2		15.3	14.4		14.2	13.4		14	13.1		85
90	16.8	15.4	13.9	14.8	13.9		15	14.1		13.9	13.2		13.7	13		90
95	16.3	15	13.6	14.4	13.6	12	14.7	13.8	12.1	13.7	13		13.5	12.9		95
100	15.9	14.7	13.4	14.1	13.2	11.7	14.4	13.6	11.9	13.4	12.8	10.9	13.3	12.6	10.7	100
105	15.5	14.4	13.1	13.8	12.9	11.5	14.1	13.3	11.6	13.2	12.6	10.7	13	12.5	10.5	105
110	15.1	14.1	12.8	13.6	12.5	11.3	13.8	12.9	11.4	12.9	12.3	10.5	12.8	12.2	10.4	110
115	14.7	13.8	12.4	13.3	12.1	11	13.5	12.6	11.1	12.7	12	10.3	12.6	11.9	10.2	115
120	14.4	13.5	12.1	13	11.8	10.8	13.2	12.2	10.9	12.5	11.7	10.1	12.3	11.6	10	120
125	14	13.2	11.8	12.7	11.5	10.6	12.9	11.9	10.7	12.2	11.4	9.9	12.1	11.3	9.8	125
130	13.7	12.9	11.6	12.4	11.2	10.4	12.7	11.6	10.5	12	11.1	9.7	11.9	11.1	9.6	130
135	13.3	12.7	11.3	12.1	10.9	10.1	12.4	11.3	10.2	11.8	10.8	9.5	11.7	10.8	9.4	135
140	13	12.4	11	11.8	10.6	9.9	12.1	11	10	11.5	10.6	9.4	11.5	10.5	9.3	140
145	12.7	12.2	10.7	11.5	10.3	9.7	11.9	10.8	9.8	11.3	10.3	9.2	11.2	10.3	9.1	145
150	12.4	12	10.5	11.2	10.1	9.5	11.6	10.5	9.6	11	10.1	9	11	10.1	8.9	150
155	12.1	11.7	10.2	10.9	9.9	9.3	11.4	10.3	9.4	10.8	9.9	8.8	10.7	9.8	8.7	155
160	11.8	11.5	9.9	10.6	9.7	9.1	11.1	10.1	9.2	10.5	9.6	8.7	10.5	9.6	8.6	160
165	11.6	11.4	9.7	10.3	9.4	8.9	10.8	9.8	9	10.3	9.5	8.5	10.2	9.4	8.4	165
170	11.3	11.2	9.4	9.9	9.2	8.7	10.5	9.6	8.8	10	9.3	8.3	10	9.2	8.2	170
175	11.1	11	9.2	9.6	9	8.5	10.3	9.4	8.6	9.7	9.1	8.2	9.7	9.1	8.1	175
180	10.9	10.8	9	9.4	8.9	8.3	10	9.2	8.4	9.5	8.9	8	9.5	8.9	7.9	180
185	10.7	10.7	8.8	9.1	8.7	8.2	9.8	9	8.2	9.2	8.7	7.8	9.2	8.7	7.8	185
190	10.5	10.6	8.6	8.9	8.5	8	9.6	8.9	8.1	9	8.6	7.7	9	8.6	7.6	190
195	10.2	10.4	8.4	8.6	8.4	7.8	9.3	8.7	7.9	8.7	8.4	7.6	8.7	8.4	7.5	195
200	10.1	10.3	8.2	8.3	8.2	7.7	9.1	8.6	7.7	8.5	8.3	7.5	8.5	8.3	7.4	200
205	9.9	10.1	8	8	8	7.5	8.9	8.4	7.6	8.2	8.1	7.3	8.2	8.1	7.3	205
210	9.7	10	7.8	7.7	7.8	7.4	8.7	8.3	7.5	8	7.9	7.2	8	7.9	7.2	210
215	9.2	9.7	7.6	7.5	7.6	7.3	8.5	8.2	7.3	7.7	7.8	7.1	7.7	7.8	7.1	215
220	8.6	9.1	7.5	7.2	7.4	7.2	8.3	8.1	7.2	7.5	7.6	7	7.5	7.6	7	220
225	8	8.5		7	7.2	7.1	8.1	8	7.1	7.3	7.4	6.9	7.3	7.4	6.9	225
230	7.8	7.9		6.8	6.9	7	7.6	7.9	7.1	7	7.2	6.8	7.1	7.2	6.8	230
235	7.6	7.7		6.6	6.7		7.2	7.6	7	6.9	7	6.8	6.9	7	6.7	235
240	7.1	7.6		6.4	6.6		6.8	7.2		6.6	6.8	6.7	6.5	6.8	6.7	240
245	5.2			6.2			6.4	6.7		6.3	6.6	6.6	6.1	6.6	6.6	245
250				5.9			5.9	6.2		5.9	6.2		5.7	6.1		250
255				4.2			4.6	5.6		5.5	5.8		5.4	5.7		255
260							2.6			4.9			5			260
265										3.6			4			265
270													2.3			270

t_259_107_12151 / 32151_00_000

Lifting capacities

Forces de levage

TVNZK

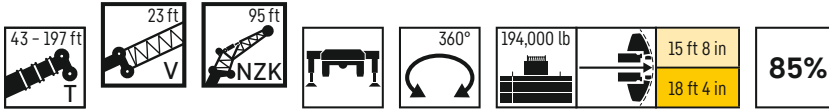

	43 ft + 23 ft			99 ft + 23 ft			114 ft + 23 ft			128 ft + 23 ft			142 ft + 23 ft			156 ft + 23 ft			
	0°	22,5°	45°	0°	22,5°	45°	0°	22,5°	45°	0°	22,5°	45°	0°	22,5°	45°	0°	22,5°	45°	
20	14.4																		20
22	14.4																		22
24	14.3																		24
26	14.3																		26
28	14.2																		28
30	14.2			14.4															30
32	14.1			14.4			13.9												32
34	14			14.4			13.9												34
36	14			14.3			13.9			13.3									36
38	13.9			14.3			13.8			13.2									38
40	13.9			14.2			13.8			13.2			12.5						40
45	13.7			14.1			13.7			13.1			12.4			11.6			45
50	13.3			14			13.6			13			12.3			11.5			50
55	12.8			13.9			13.5			12.9			12.3			11.4			55
60	12.2	10.5		13.8			13.4			12.9			12.2			11.3			60
65	11.6	10		13.6			13.3			12.7			12.1			11.3			65
70	11.1	9.5		13.3	10.6		13.1			12.6			12			11.2			70
75	10.6	9.1		12.9	10.2		12.8	10.2		12.5	10.1		11.9			11.1			75
80	10.1	8.7		12.4	9.8		12.5	9.9		12.3	9.8		11.8	9.6		11.1			80
85	9.6	8.3	7.1	12	9.5		12.1	9.6		11.9	9.5		11.6	9.3		11	9.1		85
90	9.1	8	6.9	11.6	9.2		11.7	9.2		11.6	9.2		11.3	9.1		10.8	8.8		90
95	8.7	7.6	6.7	11.2	8.9	7.1	11.3	9		11.3	8.9		11	8.8		10.6	8.6		95
100	8.3	7.4	6.5	10.8	8.6	6.9	11	8.7	6.9	10.9	8.7	6.9	10.7	8.6		10.3	8.4		100
105	7.9	7.2	6.4	10.4	8.4	6.8	10.6	8.4	6.8	10.6	8.5	6.8	10.4	8.3	6.7	10.1	8.2		105
110	7.6	7	6.3	10	8.1	6.7	10.3	8.2	6.7	10.3	8.2	6.7	10.1	8.1	6.6	9.8	8	6.6	110
115	7.3	6.7	6.2	9.7	7.9	6.6	9.9	8	6.6	10	8	6.6	9.9	8	6.5	9.6	7.8	6.5	115
120	7	6.6	6.1	9.4	7.6	6.5	9.6	7.8	6.5	9.7	7.8	6.5	9.6	7.8	6.5	9.3	7.6	6.4	120
125	6.8	6.4	6.1	9	7.5	6.4	9.3	7.6	6.4	9.4	7.6	6.4	9.3	7.6	6.4	9.1	7.5	6.3	125
130	6.5	6.3	6.1	8.7	7.3	6.3	9	7.4	6.3	9.1	7.4	6.4	9.1	7.4	6.3	8.9	7.3	6.3	130
135	6.2	6.2	6.1	8.4	7.1	6.3	8.7	7.2	6.3	8.8	7.3	6.3	8.8	7.3	6.2	8.7	7.2	6.2	135
140	6	6.1	6.1	8.1	7	6.2	8.4	7.1	6.2	8.6	7.1	6.2	8.6	7.1	6.2	8.4	7.1	6.1	140
145	5.8	6.1	6.1	7.9	6.8	6.2	8.2	6.9	6.2	8.3	7	6.2	8.3	7	6.1	8.2	6.9	6.1	145
150	5.6	6		7.6	6.7	6.1	7.9	6.8	6.1	8.1	6.9	6.1	8.1	6.9	6.1	8	6.8	6	150
155	5.5			7.4	6.6	6.1	7.7	6.7	6.1	7.8	6.7	6.1	7.9	6.8	6.1	7.8	6.7	6	155
160				7.2	6.5	6.1	7.5	6.6	6.1	7.6	6.6	6	7.7	6.7	6	7.7	6.6	5.9	160
165				7	6.4	6.1	7.3	6.5	6	7.4	6.5	6	7.5	6.6	6	7.5	6.5	5.9	165
170				6.8	6.3	6.1	7.1	6.4	6	7.3	6.4	6	7.3	6.5	5.9	7.3	6.4	5.9	170
175				6.6	6.2	6.1	6.9	6.3	6	7.1	6.3	6	7.2	6.4	5.9	7.2	6.3	5.9	175
180				6.4	6.2	6.1	6.8	6.2	6	6.9	6.3	6	7	6.3	5.9	7	6.3	5.9	180
185				6.2	6.1	6.1	6.6	6.2	6	6.8	6.2	6	6.9	6.2	5.9	6.9	6.2	5.9	185
190				6	6.1		6.4	6.1	6	6.6	6.1	6	6.7	6.1	5.9	6.8	6.1	5.9	190
195				5.8	6.1		6.2	6.1	6	6.5	6.1	6	6.6	6.1	5.9	6.6	6	5.9	195
200				5.7	6.1		6.1	6	6	6.4	6	6	6.5	6	5.9	6.5	6	5.9	200
205				5.6	6.1		5.9	6	6	6.2	6	6	6.4	6	5.9	6.4	5.9	5.9	205
210				5.5			5.8	6		6.1	6		6.3	5.9	5.9	6.3	5.9	5.9	210
215							5.6	6		5.9	6		6.1	5.9	5.9	6.2	5.9	5.9	215
220							5.5	6		5.8	6		6	5.9	5.9	6.1	5.8	5.9	220
225							5.5			5.7	6		5.9	5.9		6	5.8	5.9	225
230										5.6	6		5.8	5.9		5.9	5.8	5.9	230
235										5.5	6		5.7	5.9		5.8	5.8	5.9	235
240										4.7			5.6	5.9		5.7	5.8	5.8	240
245													5.5	5.9		5.7	5.8		245
250													5.1			5.5	5.8		250
255																5.5	5.8		255
260																5.1	5.8		260
265																4			265

t_259_107_15151 / 35151_00_000

Lifting capacities

Forces de levage

TVNZK

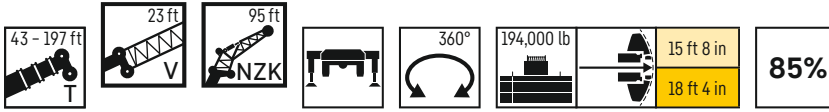

	170 ft + 23 ft			180 ft + 23 ft			184 ft + 23 ft			194 ft + 23 ft			197 ft + 23 ft			
	95 ft															
	0°	22,5°	45°	0°	22,5°	45°	0°	22,5°	45°	0°	22,5°	45°	0°	22,5°	45°	
50	10.4															50
55	10.4			9			9.2			8.4						55
60	10.3			9			9.1			8.3			8.2			60
65	10.3			9			9.1			8.3			8.2			65
70	10.2			8.9			9			8.3			8.1			70
75	10.2			8.9			9			8.2			8.1			75
80	10.1			8.9			8.9			8.2			8.1			80
85	10			8.8			8.9			8.2			8.1			85
90	10	8.4		8.8			8.9			8.2			8			90
95	9.8	8.2		8.8	7.7		8.9	7.7		8.1			8			95
100	9.7	8		8.7	7.5		8.8	7.6		8.1	7.3		8	7.3		100
105	9.5	7.9		8.6	7.4		8.7	7.4		8	7.2		7.9	7.1		105
110	9.3	7.7		8.4	7.3		8.6	7.3		8	7.1		7.8	7.1		110
115	9.1	7.5	6.3	8.3	7.2		8.4	7.2		7.9	7		7.7	6.9		115
120	8.9	7.4	6.3	8.1	7.1	6.1	8.2	7.1	6.1	7.8	6.9		7.6	6.8		120
125	8.7	7.3	6.2	8	6.9	6	8.1	7	6.1	7.7	6.8	6	7.6	6.7	5.9	125
130	8.5	7.1	6.2	7.8	6.8	6	7.9	6.9	6	7.5	6.7	5.9	7.5	6.7	5.9	130
135	8.3	7	6.1	7.7	6.7	6	7.8	6.8	6	7.4	6.6	5.9	7.4	6.6	5.8	135
140	8.1	6.9	6	7.5	6.7	5.9	7.6	6.7	5.9	7.3	6.5	5.8	7.3	6.5	5.8	140
145	7.9	6.8	6	7.4	6.6	5.8	7.5	6.6	5.9	7.2	6.4	5.8	7.2	6.4	5.7	145
150	7.8	6.7	5.9	7.3	6.5	5.8	7.4	6.5	5.8	7.1	6.3	5.8	7.1	6.3	5.7	150
155	7.6	6.6	5.9	7.2	6.4	5.8	7.2	6.4	5.8	7	6.3	5.7	7	6.2	5.7	155
160	7.4	6.5	5.9	7.1	6.3	5.8	7.1	6.3	5.8	6.9	6.2	5.7	6.9	6.2	5.7	160
165	7.3	6.4	5.8	6.9	6.2	5.8	7	6.3	5.7	6.8	6.1	5.7	6.8	6.1	5.7	165
170	7.2	6.4	5.8	6.8	6.1	5.7	6.9	6.2	5.7	6.7	6.1	5.6	6.7	6	5.6	170
175	7	6.3	5.8	6.7	6.1	5.7	6.8	6.1	5.7	6.6	6	5.6	6.6	6	5.6	175
180	6.9	6.2	5.8	6.6	6	5.7	6.7	6	5.7	6.5	5.9	5.6	6.5	5.9	5.6	180
185	6.8	6.1	5.8	6.5	6	5.7	6.6	6	5.7	6.4	5.9	5.6	6.4	5.9	5.6	185
190	6.7	6.1	5.8	6.4	5.9	5.7	6.5	5.9	5.7	6.3	5.8	5.6	6.3	5.8	5.5	190
195	6.6	6	5.8	6.3	5.9	5.7	6.4	5.9	5.7	6.3	5.8	5.6	6.2	5.8	5.5	195
200	6.5	5.9	5.8	6.2	5.8	5.7	6.3	5.8	5.7	6.2	5.7	5.5	6.1	5.7	5.4	200
205	6.4	5.9	5.8	6.1	5.7	5.6	6.2	5.8	5.7	6.1	5.7	5.5	6.1	5.7	5.4	205
210	6.3	5.8	5.8	6	5.6	5.6	6.1	5.7	5.7	6	5.6	5.4	6	5.6	5.3	210
215	6.2	5.8	5.8	5.9	5.5	5.5	6.1	5.7	5.7	5.9	5.5	5.3	5.9	5.5	5.2	215
220	6.1	5.8	5.8	5.8	5.4	5.5	6	5.6	5.6	5.8	5.5	5.3	5.8	5.5	5.2	220
225	6	5.8	5.8	5.7	5.3	5.4	5.9	5.5	5.5	5.7	5.4	5.2	5.7	5.4	5.1	225
230	5.9	5.7	5.8	5.5	5.3	5.4	5.8	5.4	5.4	5.6	5.3	5.1	5.6	5.3	5.1	230
235	5.9	5.7	5.7	5.4	5.2	5.3	5.7	5.4	5.3	5.5	5.2	5.1	5.5	5.2	5	235
240	5.8	5.7	5.6	5.3	5.1	5.3	5.6	5.3	5.2	5.4	5.2	5	5.4	5.2	4.9	240
245	5.7	5.7	5.5	5.2	5.1	5.2	5.5	5.2	5.2	5.3	5.1	4.9	5.3	5.1	4.9	245
250	5.7	5.7	5.4	5.2	5	5.1	5.4	5.2	5.1	5.2	5	4.9	5.2	5.1	4.8	250
255	5.6	5.7		5	5	5	5.3	5.2	5.1	5.1	5	4.8	5.1	5	4.8	255
260	5.5	5.7		4.9	4.9	5	5.2	5.1	5	5	4.9	4.8	5	4.9	4.7	260
265	5.2	5.6		4.8	4.9		5.1	5.1	5	4.9	4.9	4.7	4.9	4.9	4.7	265
270	5	5.2		4.6	4.8		4.9	5.1		4.8	4.9	4.7	4.6	4.8	4.7	270
275	3.9			4.5	4.6		4.6	5		4.4	4.8		4.3	4.8		275
280				4.2	4.5		4.2	4.7		4.1	4.6		3.9	4.5		280
285				2.9			3	4.3		3.7	4.2		3.6			285
290										3.2	3.8		3.2			290
295													2.2			295

t_259_107_15151 / 35151_00_000

Lifting heights

Hauteurs de levage

TVNZK

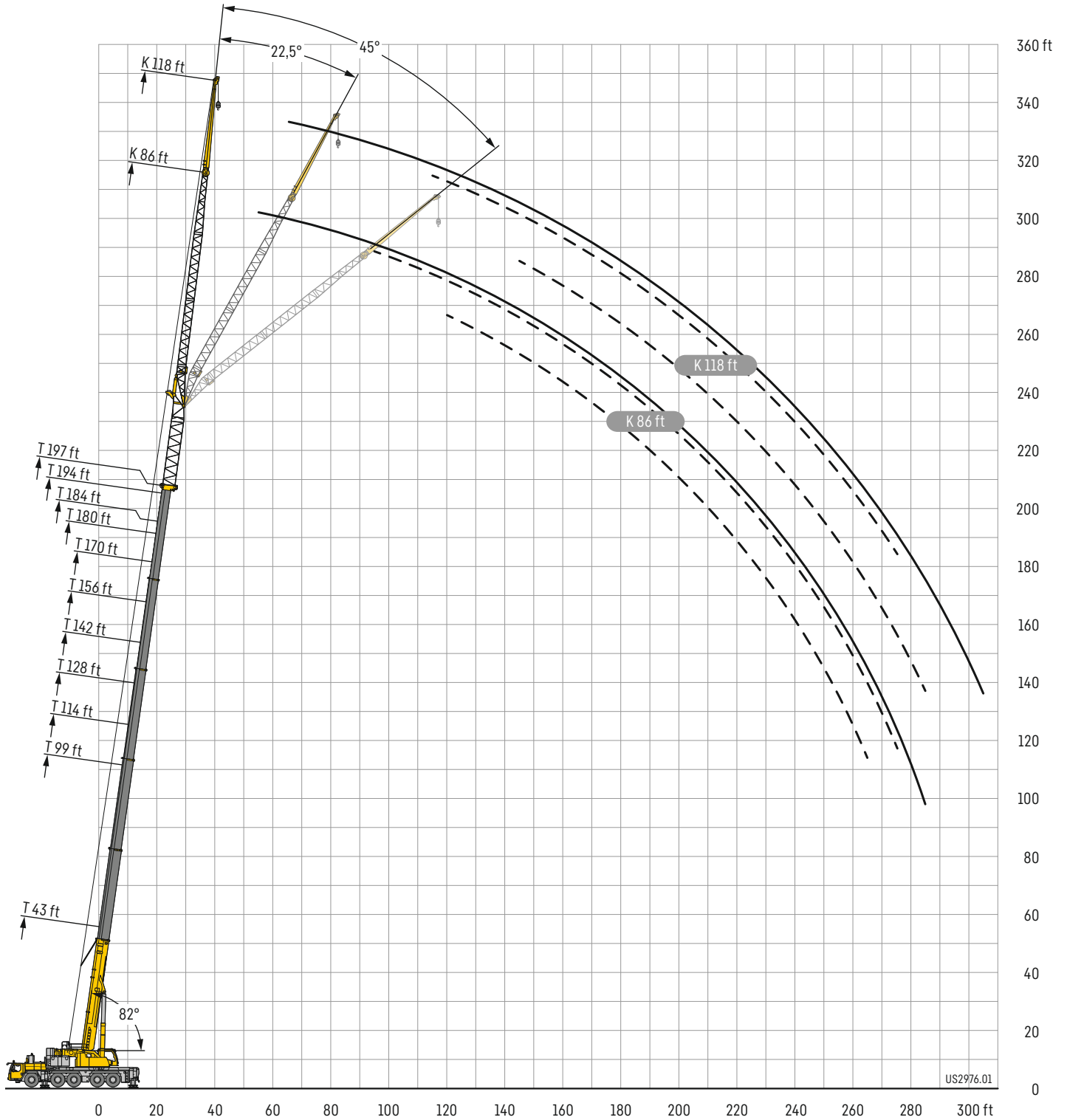

Lifting capacities

Forces de levage

TVNZK

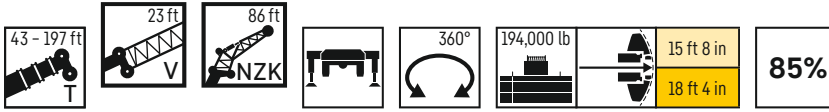

	43 ft + 23 ft			99 ft + 23 ft			114 ft + 23 ft			128 ft + 23 ft			142 ft + 23 ft			156 ft + 23 ft			
	86 ft																		
	0°	22,5°	45°	0°	22,5°	45°	0°	22,5°	45°	0°	22,5°	45°	0°	22,5°	45°	0°	22,5°	45°	
19	20.4																		19
20	20.4																		20
22	20.4																		22
24	20.3																		24
26	20.2																		26
28	20.1																		28
30	19.9			20.4															30
32	19.8			20.4			19.5												32
34	19.6			20.3			19.4												34
36	19.4			20.2			19.3			18.2									36
38	19			20.1			19.2			18.1			16.7						38
40	18.7			20.1			19.2			18			16.7						40
45	17.8			19.8			19			17.8			16.6			15			45
50	17			19.5			18.8			17.7			16.4			14.9			50
55	16.1	13.1		18.9			18.5			17.5			16.3			14.8			55
60	15.2	12.4		18.3			18			17.3			16.1			14.7			60
65	14.3	11.7		17.6	13.3		17.5			16.9			16			14.6			65
70	13.5	11.1		17	12.7		16.9	12.7		16.4	12.6		15.6			14.5			70
75	12.7	10.6	8.7	16.4	12.2		16.3	12.3		16	12.2		15.3	11.9		14.2			75
80	12	10.1	8.4	15.7	11.8		15.8	11.8		15.5	11.8		14.9	11.5		14	11.2		80
85	11.3	9.7	8.1	15	11.3		15.2	11.4		15	11.4		14.5	11.2		13.7	10.9		85
90	10.7	9.3	7.9	14.4	10.9	8.5	14.6	11.1	8.5	14.5	11		14.1	10.9		13.4	10.6		90
95	10.2	8.9	7.7	13.8	10.6	8.3	14.1	10.7	8.3	14	10.7	8.2	13.7	10.5		13.1	10.3		95
100	9.6	8.5	7.5	13.2	10.2	8.1	13.5	10.4	8.1	13.5	10.3	8.1	13.3	10.3	8	12.7	10	7.9	100
105	9.1	8.2	7.4	12.6	9.9	8	13	10	8	13.1	10.1	7.9	12.9	10	7.9	12.4	9.8	7.8	105
110	8.6	7.9	7.2	12.1	9.6	7.8	12.5	9.7	7.8	12.6	9.8	7.8	12.5	9.7	7.7	12.1	9.5	7.6	110
115	8.1	7.7	7.2	11.7	9.3	7.7	12	9.5	7.7	12.2	9.5	7.7	12.1	9.5	7.6	11.7	9.3	7.5	115
120	7.6	7.5	7.2	11.2	9	7.5	11.6	9.2	7.6	11.7	9.3	7.6	11.7	9.3	7.5	11.4	9.1	7.4	120
125	7.3	7.3	7.2	10.8	8.8	7.4	11.2	9	7.5	11.3	9	7.5	11.3	9	7.4	11.1	8.9	7.4	125
130	7	7.2	7.2	10.4	8.5	7.4	10.8	8.7	7.4	11	8.8	7.4	11	8.8	7.3	10.8	8.7	7.3	130
135	6.7	7.1	7.2	10	8.3	7.3	10.4	8.5	7.3	10.6	8.6	7.3	10.6	8.6	7.3	10.5	8.5	7.2	135
140	6.4	7.1		9.6	8.1	7.2	10	8.3	7.2	10.2	8.4	7.2	10.3	8.4	7.2	10.2	8.3	7.1	140
145	6.3			9.2	7.9	7.2	9.7	8.1	7.2	9.9	8.2	7.2	10	8.2	7.1	9.9	8.2	7.1	145
150				8.7	7.8	7.2	9.3	7.9	7.1	9.6	8	7.1	9.7	8.1	7.1	9.6	8	7	150
155				8.4	7.6	7.2	9	7.8	7.1	9.3	7.9	7.1	9.4	7.9	7.1	9.4	7.9	7	155
160				8	7.5	7.2	8.7	7.6	7.1	9	7.7	7.1	9.2	7.8	7	9.1	7.7	7	160
165				7.7	7.4	7.2	8.3	7.5	7.1	8.7	7.6	7	8.9	7.7	7	8.9	7.6	6.9	165
170				7.4	7.3	7.2	8	7.4	7.1	8.5	7.5	7	8.7	7.5	7	8.7	7.5	6.9	170
175				7.2	7.2	7.2	7.7	7.3	7.1	8.2	7.4	7	8.4	7.4	7	8.5	7.4	6.9	175
180				7	7.2	7.2	7.5	7.2	7.1	7.9	7.3	7	8.2	7.3	7	8.3	7.3	6.9	180
185				6.8	7.1		7.2	7.1	7.1	7.6	7.2	7	8	7.2	7	8.1	7.2	6.9	185
190				6.6	7.1		7	7.1	7.1	7.4	7.1	7	7.8	7.1	7	7.9	7.1	6.9	190
195				6.4	7.1		6.8	7.1		7.2	7.1	7	7.6	7.1	7	7.7	7	6.9	195
200				6.3			6.7	7.1		7	7	7	7.3	7	7	7.6	7	6.9	200
205							6.5	7.1		6.9	7		7.2	7	7	7.4	6.9	6.9	205
210							6.4	7.1		6.7	7		7	6.9	6.9	7.2	6.9	6.7	210
215							6.3			6.5	7		6.8	6.9		7.1	6.9	6.6	215
220										6.4	7		6.7	6.9		6.9	6.8	6.4	220
225										6.3	7		6.5	6.9		6.8	6.8	6.3	225
230										5.6			6.4	6.8		6.6	6.8	6.1	230
235													6.3	6.8		6.5	6.7		235
240													5.6			6.4	6.7		240
245													3.6			6.3	6.7		245
250																5.9	6.7		250
255																4.8			255

t_259_107_14151 / 34151_00_000

Lifting capacities

Forces de levage

TVNZK

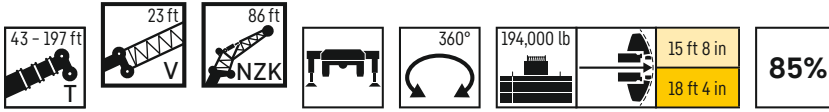

	170 ft + 23 ft			180 ft + 23 ft			184 ft + 23 ft			194 ft + 23 ft			197 ft + 23 ft			
	0°	22,5°	45°	0°	22,5°	45°	0°	22,5°	45°	0°	22,5°	45°	0°	22,5°	45°	
50	13.2			11.2												50
55	13.1			11.2			11.3			10.2			10			55
60	13.1			11.1			11.2			10.2			10			60
65	13			11.1			11.2			10.1			10			65
70	12.9			11			11.1			10.1			9.9			70
75	12.8			11			11.1			10.1			9.9			75
80	12.7			10.9			11.1			10			9.9			80
85	12.5	10.4		10.8			11			9.9			9.7			85
90	12.3	10.1		10.7	9.3		10.9	9.4		9.8			9.6			90
95	12.1	9.9		10.6	9.2		10.8	9.2		9.7	8.8		9.5	8.6		95
100	11.9	9.6		10.5	9		10.6	9.1		9.6	8.7		9.4	8.6		100
105	11.6	9.4	7.6	10.3	8.8		10.5	8.9		9.5	8.5		9.3	8.4		105
110	11.3	9.2	7.5	10.1	8.6		10.3	8.7		9.4	8.3		9.2	8.3		110
115	11.1	9	7.4	10	8.5	7.2	10.1	8.5	7.2	9.3	8.2		9.1	8.1		115
120	10.8	8.8	7.3	9.7	8.3	7.1	9.9	8.4	7.1	9.1	8	7	9.1	8	7	120
125	10.5	8.6	7.2	9.5	8.2	7	9.7	8.2	7.1	9	7.9	6.9	8.9	7.9	6.9	125
130	10.3	8.5	7.2	9.4	8	7	9.5	8.1	7	8.9	7.8	6.9	8.8	7.8	6.9	130
135	10	8.3	7.1	9.2	7.9	6.9	9.3	7.9	6.9	8.7	7.7	6.8	8.7	7.6	6.8	135
140	9.8	8.1	7.1	9	7.7	6.9	9.1	7.8	6.9	8.6	7.6	6.8	8.5	7.5	6.8	140
145	9.6	8	7	8.7	7.6	6.9	8.9	7.7	6.8	8.4	7.5	6.7	8.4	7.4	6.7	145
150	9.3	7.9	7	8.5	7.5	6.8	8.7	7.6	6.8	8.3	7.4	6.7	8.2	7.3	6.7	150
155	9.1	7.7	6.9	8.3	7.4	6.8	8.5	7.5	6.8	8.1	7.3	6.7	8	7.3	6.6	155
160	8.9	7.6	6.9	8.1	7.2	6.8	8.4	7.4	6.8	8	7.2	6.6	7.9	7.2	6.6	160
165	8.7	7.5	6.9	7.9	7.1	6.7	8.2	7.3	6.7	7.8	7.1	6.6	7.8	7.1	6.5	165
170	8.5	7.4	6.8	7.7	6.9	6.6	8	7.2	6.7	7.6	6.9	6.5	7.6	6.9	6.4	170
175	8.3	7.3	6.8	7.5	6.8	6.5	7.8	7	6.7	7.5	6.8	6.4	7.5	6.8	6.3	175
180	8.1	7.2	6.8	7.3	6.7	6.5	7.6	6.9	6.6	7.3	6.7	6.3	7.3	6.7	6.2	180
185	8	7.1	6.8	7.1	6.6	6.4	7.4	6.8	6.6	7.2	6.6	6.2	7.2	6.6	6.1	185
190	7.8	7.1	6.8	7	6.4	6.3	7.3	6.6	6.5	7	6.4	6.1	7	6.4	6	190
195	7.6	7	6.7	6.8	6.3	6.2	7.1	6.5	6.3	6.9	6.3	6	6.9	6.3	5.9	195
200	7.5	6.9	6.7	6.7	6.2	6.1	6.9	6.4	6.2	6.7	6.2	5.9	6.7	6.2	5.8	200
205	7.4	6.9	6.6	6.5	6.1	6.1	6.8	6.3	6.1	6.6	6.1	5.8	6.6	6.1	5.7	205
210	7.2	6.8	6.4	6.4	6	6	6.6	6.2	6	6.5	6	5.7	6.5	6	5.7	210
215	7.1	6.8	6.3	6.2	5.9	5.9	6.5	6.1	5.9	6.3	5.9	5.6	6.3	5.9	5.6	215
220	7	6.7	6.2	6.1	5.8	5.8	6.4	6	5.8	6.2	5.8	5.5	6.2	5.8	5.5	220
225	6.8	6.7	6.1	6	5.7	5.7	6.3	5.9	5.7	6.1	5.8	5.4	6.1	5.7	5.4	225
230	6.7	6.7	5.9	5.9	5.6	5.6	6.1	5.8	5.6	6	5.7	5.4	6	5.7	5.3	230
235	6.6	6.6	5.8	5.8	5.6	5.5	6	5.8	5.5	5.9	5.6	5.3	5.9	5.6	5.2	235
240	6.5	6.6	5.7	5.6	5.5	5.4	5.9	5.7	5.4	5.8	5.5	5.2	5.8	5.5	5.2	240
245	6.3	6.5	5.6	5.4	5.5	5.3	5.8	5.6	5.4	5.6	5.5	5.1	5.6	5.5	5.1	245
250	6	6.4		5.2	5.4	5.3	5.7	5.6	5.3	5.5	5.4	5.1	5.5	5.4	5	250
255	5.6	6		5.1	5.3	5.3	5.6	5.6	5.2	5.3	5.4	5	5.3	5.4	5	255
260	5.5	5.6		5	5.1		5.3	5.6		5.1	5.3	5	5.1	5.3	4.9	260
265	4.6	5.6		4.8	4.9		5	5.4		4.9	5.2		4.7	5.2	4.9	265
270	2.5			4.7	4.8		4.7	5		4.5	5		4.3	4.9		270
275				3.6			3.7	4.6		4.1	4.6		4	4.5		275
280										3.8	4.2		3.6			280
285										2.6	3.7		2.8			285

t_259_107_14151 / 34151_00_000

Lifting capacities

Forces de levage

TVNZK

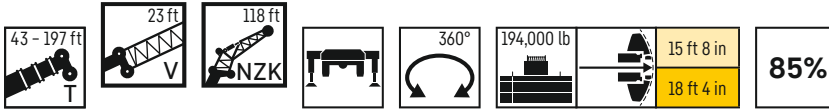

	43 ft + 23 ft			99 ft + 23 ft			114 ft + 23 ft			128 ft + 23 ft			142 ft + 23 ft			156 ft + 23 ft			
	0°	22,5°	45°	0°	22,5°	45°	0°	22,5°	45°	0°	22,5°	45°	0°	22,5°	45°	0°	22,5°	45°	
24	10.4																		24
26	10.4																		26
28	10.4																		28
30	10.3																		30
32	10.3																		32
34	10.2			10.3															34
36	10.2			10.3															36
38	10.1			10.3			10												38
40	10.1			10.3			10			9.5									40
45	9.9			10.2			9.9			9.5			8.9						45
50	9.7			10.1			9.8			9.4			8.8			8.1			50
55	9.3			10			9.7			9.3			8.8			8.1			55
60	8.9			9.9			9.6			9.2			8.7			8			60
65	8.5			9.8			9.6			9.1			8.6			8			65
70	8	6.8		9.6			9.4			9			8.5			7.9			70
75	7.6	6.6		9.2			9.2			8.9			8.4			7.8			75
80	7.3	6.3		8.9			8.9			8.7			8.4			7.8			80
85	7	6		8.6	6.7		8.6	6.7		8.5			8.2			7.7			85
90	6.7	5.8		8.2	6.5		8.3	6.5		8.2	6.4		8			7.6			90
95	6.4	5.5		7.9	6.2		8	6.3		7.9	6.2		7.7	6.1		7.4			95
100	6.1	5.3		7.6	6		7.7	6.1		7.7	6		7.5	6		7.2	5.8		100
105	5.8	5.1	4.4	7.4	5.9		7.5	5.9		7.4	5.9		7.3	5.8		7.1	5.6		105
110	5.6	4.9	4.3	7.1	5.7		7.2	5.7		7.2	5.7		7.1	5.6		6.9	5.5		110
115	5.3	4.8	4.2	6.9	5.5	4.4	7	5.6		7	5.5		6.9	5.5		6.7	5.4		115
120	5.1	4.6	4	6.6	5.4	4.3	6.8	5.4	4.3	6.8	5.4	4.3	6.7	5.4		6.5	5.2		120
125	4.9	4.5	4	6.4	5.2	4.2	6.5	5.3	4.2	6.6	5.3	4.2	6.5	5.2	4.2	6.4	5.1		125
130	4.7	4.3	3.9	6.2	5.1	4.2	6.3	5.1	4.2	6.4	5.1	4.1	6.4	5.1	4.1	6.2	5	4.1	130
135	4.6	4.2	3.8	6	4.9	4.1	6.1	5	4.1	6.2	5	4.1	6.2	5	4.1	6.1	4.9	4	135
140	4.4	4.1	3.8	5.8	4.8	4	5.9	4.9	4	6	4.9	4	6	4.9	4	5.9	4.8	3.9	140
145	4.2	4	3.7	5.6	4.7	4	5.8	4.7	4	5.8	4.8	4	5.8	4.7	3.9	5.8	4.7	3.9	145
150	4.1	3.9	3.7	5.4	4.6	3.9	5.6	4.6	3.9	5.7	4.7	3.9	5.7	4.6	3.9	5.6	4.6	3.8	150
155	4	3.8	3.7	5.2	4.4	3.9	5.4	4.5	3.9	5.5	4.5	3.9	5.5	4.5	3.8	5.5	4.5	3.8	155
160	3.8	3.7	3.7	5.1	4.4	3.8	5.3	4.4	3.8	5.3	4.5	3.8	5.4	4.4	3.8	5.3	4.4	3.7	160
165	3.7	3.7	3.7	4.9	4.3	3.8	5.1	4.3	3.8	5.2	4.4	3.8	5.2	4.4	3.7	5.2	4.3	3.7	165
170	3.5	3.7		4.8	4.2	3.7	4.9	4.2	3.7	5	4.3	3.7	5.1	4.3	3.7	5.1	4.2	3.7	170
175	3.4	3.7		4.6	4.1	3.7	4.8	4.2	3.7	4.9	4.2	3.7	5	4.2	3.7	4.9	4.2	3.6	175
180				4.5	4	3.7	4.7	4.1	3.7	4.8	4.1	3.7	4.8	4.1	3.6	4.8	4.1	3.6	180
185				4.4	3.9	3.7	4.5	4	3.7	4.6	4	3.6	4.7	4	3.6	4.7	4	3.6	185
190				4.3	3.9	3.7	4.4	3.9	3.7	4.5	4	3.6	4.6	4	3.6	4.6	4	3.6	190
195				4.2	3.8	3.7	4.3	3.9	3.7	4.4	3.9	3.6	4.5	3.9	3.6	4.5	3.9	3.5	195
200				4.1	3.8	3.7	4.2	3.8	3.7	4.3	3.8	3.6	4.4	3.8	3.6	4.4	3.8	3.5	200
205				4	3.7	3.7	4.1	3.8	3.7	4.2	3.8	3.6	4.3	3.8	3.6	4.3	3.8	3.5	205
210				3.8	3.7		4	3.7	3.7	4.1	3.7	3.6	4.2	3.7	3.6	4.2	3.7	3.5	210
215				3.7	3.7		3.9	3.7	3.7	4	3.7	3.6	4.1	3.7	3.6	4.1	3.7	3.5	215
220				3.6	3.7		3.8	3.7	3.7	3.9	3.7	3.6	4	3.7	3.6	4	3.6	3.5	220
225				3.5	3.7		3.7	3.6		3.9	3.6	3.6	3.9	3.6	3.6	4	3.6	3.5	225
230				3.4	3.7		3.6	3.6		3.8	3.6	3.6	3.9	3.6	3.6	3.9	3.6	3.5	230
235				3.4			3.6	3.6		3.7	3.6		3.8	3.6	3.6	3.8	3.5	3.5	235
240							3.5	3.6		3.6	3.6		3.7	3.6	3.6	3.7	3.5	3.5	240
245							3.4			3.6	3.6		3.6	3.5	3.6	3.7	3.5	3.5	245
250										3.5	3.6		3.6	3.5		3.6	3.5	3.5	250
255										3.4	3.6		3.6	3.5		3.6	3.5	3.5	255
260										3.4			3.5	3.5		3.5	3.5		260
265													3.4	3.5		3.5	3.5		265
270													3.4			3.4	3.5		270
275													3.4			3.4			275
280																3.4			280
285																3.3			285

t 259_107_16151 / 36151_00_000

Lifting capacities

Forces de levage

TVNZK

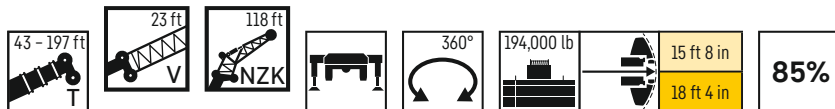

	170 ft + 23 ft			180 ft + 23 ft			184 ft + 23 ft			194 ft + 23 ft			197 ft + 23 ft			
	118 ft															
	0°	22,5°	45°	0°	22,5°	45°	0°	22,5°	45°	0°	22,5°	45°	0°	22,5°	45°	
55	7.3															55
60	7.3			6.2			6.3									60
65	7.2			6.2			6.3			5.9			5.8			65
70	7.2			6.2			6.3			5.9			5.8			70
75	7.2			6.2			6.3			5.9			5.8			75
80	7.1			6.2			6.3			5.9			5.8			80
85	7.1			6.2			6.3			5.8			5.7			85
90	7			6.2			6.3			5.8			5.7			90
95	7			6.2			6.3			5.8			5.7			95
100	6.8			6.2			6.2			5.8			5.7			100
105	6.7	5.5		6.1			6.2			5.8			5.7			105
110	6.5	5.3		6	5		6	5.1		5.7			5.7			110
115	6.4	5.2		5.9	4.9		5.9	5		5.6	4.8		5.6	4.7		115
120	6.2	5.1		5.7	4.8		5.8	4.9		5.5	4.7		5.5	4.7		120
125	6.1	5		5.6	4.7		5.7	4.8		5.4	4.6		5.4	4.6		125
130	6	4.9		5.5	4.6		5.6	4.7		5.3	4.5		5.3	4.5		130
135	5.8	4.8	3.9	5.4	4.5		5.5	4.6		5.2	4.4		5.2	4.4		135
140	5.7	4.7	3.9	5.3	4.4	3.7	5.4	4.5	3.7	5.1	4.4		5.1	4.3		140
145	5.6	4.6	3.8	5.2	4.4	3.7	5.2	4.4	3.7	5	4.3	3.6	5	4.3	3.6	145
150	5.4	4.5	3.8	5.1	4.3	3.7	5.1	4.3	3.7	4.9	4.2	3.6	4.9	4.2	3.6	150
155	5.3	4.4	3.7	5	4.2	3.6	5	4.3	3.6	4.8	4.1	3.5	4.8	4.1	3.5	155
160	5.2	4.3	3.7	4.9	4.1	3.6	4.9	4.2	3.6	4.7	4.1	3.5	4.7	4	3.5	160
165	5.1	4.2	3.6	4.8	4.1	3.6	4.8	4.1	3.6	4.7	4	3.5	4.6	4	3.5	165
170	5	4.2	3.6	4.7	4	3.5	4.7	4	3.5	4.6	3.9	3.4	4.5	3.9	3.4	170
175	4.9	4.1	3.6	4.6	4	3.5	4.6	4	3.5	4.5	3.9	3.4	4.5	3.9	3.4	175
180	4.7	4	3.5	4.5	3.9	3.5	4.6	3.9	3.5	4.4	3.8	3.4	4.4	3.8	3.4	180
185	4.6	3.9	3.5	4.4	3.8	3.4	4.5	3.9	3.4	4.3	3.8	3.4	4.3	3.8	3.4	185
190	4.5	3.9	3.5	4.3	3.8	3.4	4.4	3.8	3.4	4.2	3.7	3.4	4.2	3.7	3.4	190
195	4.4	3.8	3.5	4.2	3.7	3.4	4.3	3.8	3.4	4.2	3.7	3.4	4.1	3.7	3.3	195
200	4.3	3.8	3.5	4.2	3.7	3.4	4.2	3.7	3.4	4.1	3.6	3.4	4.1	3.6	3.3	200
205	4.3	3.7	3.5	4.1	3.6	3.4	4.1	3.7	3.4	4	3.6	3.4	4	3.6	3.3	205
210	4.2	3.7	3.5	4	3.6	3.4	4.1	3.6	3.4	4	3.5	3.4	4	3.5	3.3	210
215	4.1	3.7	3.5	3.9	3.5	3.4	4	3.6	3.4	3.9	3.5	3.4	3.9	3.5	3.3	215
220	4	3.6	3.5	3.9	3.5	3.4	3.9	3.5	3.4	3.8	3.5	3.4	3.8	3.5	3.3	220
225	3.9	3.5	3.5	3.8	3.5	3.4	3.9	3.5	3.4	3.8	3.4	3.4	3.8	3.4	3.3	225
230	3.9	3.5	3.5	3.7	3.4	3.4	3.8	3.5	3.4	3.7	3.4	3.4	3.7	3.4	3.3	230
235	3.8	3.5	3.5	3.7	3.4	3.4	3.7	3.4	3.4	3.7	3.4	3.4	3.6	3.4	3.3	235
240	3.7	3.5	3.5	3.6	3.4	3.4	3.7	3.4	3.4	3.6	3.3	3.3	3.6	3.3	3.3	240
245	3.7	3.4	3.5	3.6	3.4	3.4	3.6	3.4	3.4	3.5	3.3	3.3	3.5	3.3	3.3	245
250	3.6	3.4	3.5	3.5	3.4	3.4	3.5	3.4	3.4	3.5	3.3	3.3	3.5	3.3	3.2	250
255	3.6	3.4	3.5	3.5	3.4	3.4	3.5	3.3	3.4	3.5	3.3	3.2	3.5	3.3	3.2	255
260	3.5	3.4	3.5	3.4	3.4	3.4	3.5	3.3	3.4	3.4	3.3	3.2	3.4	3.3	3.1	260
265	3.5	3.4	3.5	3.4		3.4	3.4	3.3	3.4	3.4	3.3	3.2	3.4	3.3	3.1	265
270	3.4	3.4	3.5	3.4		3.4	3.4	3.3	3.4	3.3	3.3	3.1	3.3	3.3	3.1	270
275	3.4	3.4		3.3			3.3	3.3	3.4	3.3		3.1	3.3	3.3	3	275
280	3.3	3.4		3.3			3.3	3.3	3.4	3.3		3.1	3.3		3	280
285	3.3	3.4		3.3			3.3	3.3		3.2			3.2		3	285
290	3.3			3.2			3.3			3.2			3.1			290
295	3.1			3.2			3.2			3			2.8			295
300				3.1			2.8			2.7			2.5			300
305										2.4						305

t_259_107_16151 / 36151_00_000

Lifting heights

Hauteurs de levage

TVNZK

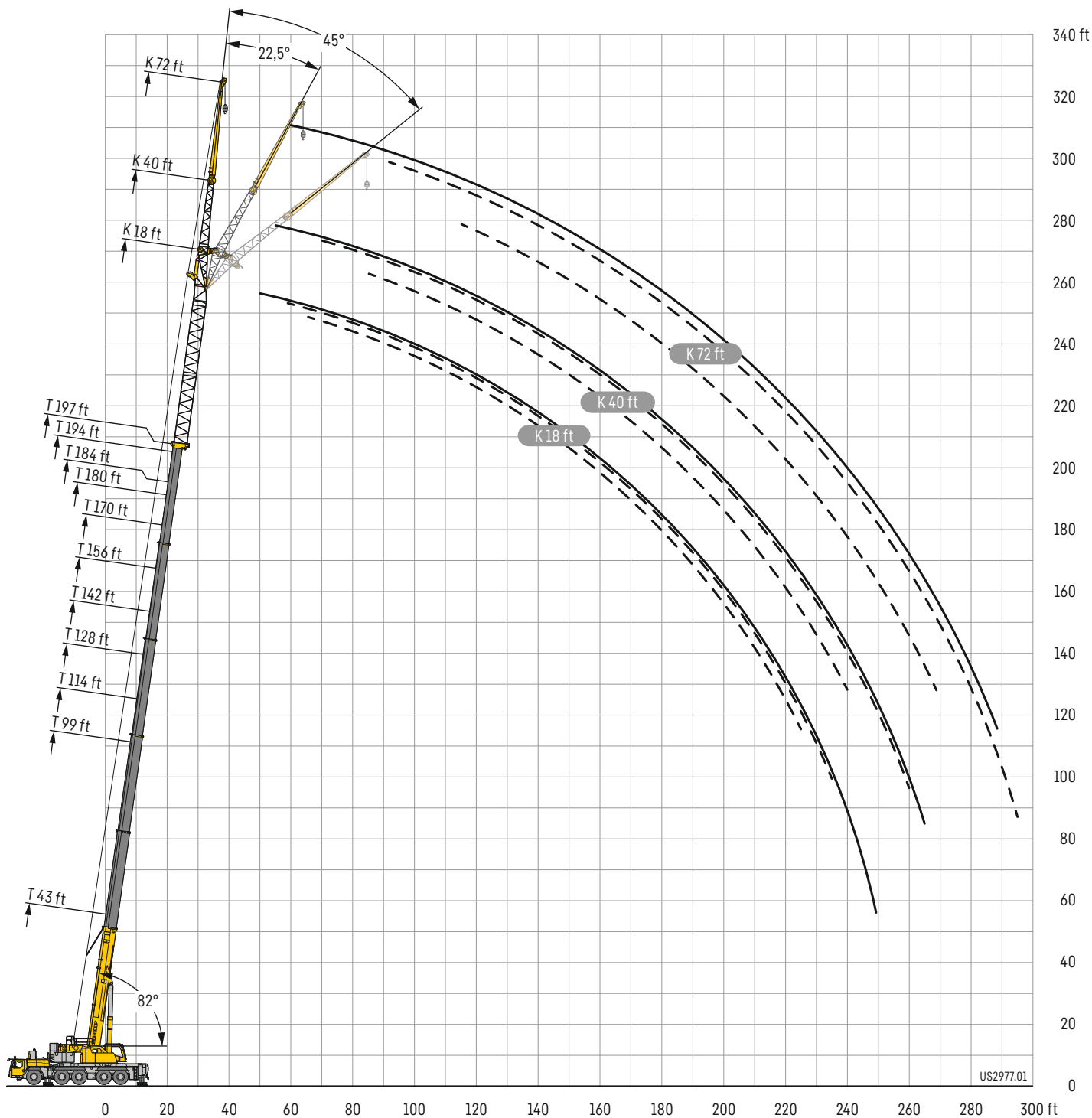

Lifting capacities

Forces de levage

TVNZK

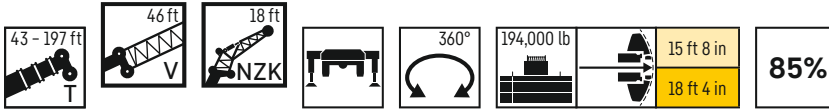

	43 ft + 46 ft			99 ft + 46 ft			114 ft + 46 ft			128 ft + 46 ft			142 ft + 46 ft			156 ft + 46 ft			
	18 ft																		
	0°	22,5°	45°	0°	22,5°	45°	0°	22,5°	45°	0°	22,5°	45°	0°	22,5°	45°	0°	22,5°	45°	
15	50.8																		15
16	50.7																		16
17	49.9																		17
18	48.9																		18
19	48																		19
20	47	44.2																	20
22	45.2	43.4																	22
24	43.2	41.7	40.2																24
26	41.3	40.1	39.2	50.4															26
28	39.5	38.5	37.7	49.2															28
30	37.8	37	36.3	48			47												30
32	36.3	35.7	35	46.8	43.5		46			43									32
34	34.8	34.3	33.7	45.6	42.5		45	42		42.3									34
36	33.5	33.1	32.6	44.3	41.4	39.4	44	41.1		41.5			38.3						36
38	32.1	32	31.5	43.1	40.3	38.5	42.9	40.1	38.2	40.7	38.3		37.8						38
40	30.9	30.9	30.5	41.8	39.3	37.5	41.9	39.1	37.4	39.8	37.6		37.2			33.5			40
45	28.2	28.5	28.1	38.9	36.9	35.4	39.2	37	35.4	37.8	35.8	34.4	35.7	34	32.7	32.5	31.2		45
50	26	26.3	26.1	36.3	34.7	33.4	36.8	35	33.6	35.8	34.1	32.9	34.1	32.6	31.6	31.4	30.2	29.3	50
55	23.9	24.3	24.4	34	32.7	31.6	34.6	33.1	31.9	33.9	32.5	31.4	32.5	31.2	30.4	30.3	29.2	28.5	55
60	22.1	22.5	22.8	31.8	31	30	32.7	31.4	30.4	32.2	31	30.1	31.1	30	29.2	29.1	28.2	27.6	60
65	20.6	20.9	21.2	30	29.4	28.6	30.9	30	29.1	30.6	29.6	28.8	29.7	28.8	28.1	28	27.2	26.7	65
70	19.2	19.5	19.8	28.2	27.9	27.2	29.2	28.5	27.8	29.1	28.4	27.7	28.5	27.7	27.1	27	26.3	25.8	70
75	18	18.3	18.6	26.8	26.5	25.9	27.7	27.2	26.6	27.7	27.2	26.6	27.3	26.7	26.1	26	25.4	25	75
80	16.8	17.2	17.5	25.3	25.2	24.9	26.3	26	25.5	26.5	26.1	25.6	26.1	25.7	25.2	25	24.6	24.2	80
85	15.7	16.3	16.6	24	23.9	23.8	25.1	24.9	24.5	25.3	25	24.7	25.1	24.7	24.3	24.2	23.8	23.5	85
90	14.8	15.4	15	22.9	22.8	22.8	23.9	23.7	23.6	24.3	24.1	23.8	24.1	23.9	23.5	23.3	23.1	22.8	90
95	13.9	14.7	9.1	21.7	21.7	21.8	22.8	22.6	22.7	23.3	23.1	23	23.1	23	22.8	22.5	22.4	22.2	95
100	13.3	13.8		20.8	20.7	20.9	21.8	21.7	21.8	22.3	22.2	22.2	22.3	22.2	22.1	21.7	21.7	21.5	100
105				19.8	19.9	20	20.9	20.8	21	21.4	21.4	21.4	21.5	21.4	21.4	21	21	20.9	105
110				19	19	19.2	20	20	20.2	20.6	20.6	20.7	20.7	20.7	20.8	20.4	20.4	20.4	110
115				18.2	18.3	18.5	19.2	19.3	19.5	19.8	19.8	20	20	20	20.2	19.7	19.8	19.8	115
120				17.4	17.6	17.8	18.5	18.5	18.7	19.1	19.1	19.3	19.4	19.3	19.5	19.1	19.1	19.3	120
125				16.7	17	17.2	17.8	17.9	18.1	18.4	18.5	18.7	18.7	18.7	19	18.5	18.6	18.8	125
130				16	16.4	16.7	17.2	17.3	17.6	17.8	17.9	18.1	18.1	18.2	18.4	18	18.1	18.3	130
135				15.4	15.8	16	16.5	16.7	17	17.2	17.3	17.6	17.6	17.7	17.9	17.5	17.6	17.8	135
140				14.8	15.3	12.7	15.9	16.2	16.5	16.7	16.8	17.1	17	17.1	17.4	17	17.1	17.4	140
145				14.2	14.9		15.4	15.7	16.1	16.1	16.3	16.6	16.6	16.7	16.9	16.6	16.7	17	145
150				13.7			14.8	15.3	14.2	15.6	15.9	16.2	16.1	16.2	16.5	16.2	16.3	16.6	150
155				13.4			14.3	14.9		15.1	15.5	15.7	15.6	15.8	16.1	15.7	15.9	16.2	155
160							13.9			14.6	15.1	15.2	15.2	15.4	15.7	15.4	15.5	15.8	160
165							13.5			14.2	14.7	12.7	14.8	15.1	15.2	15	15.2	15.4	165
170							12.2			13.8	14.4		14.4	14.8	14.8	14.6	14.9	15	170
175										13.4			14	14.5	13.5	14.3	14.5	14.5	175
180										12.7			13.6	14.1		13.6	13.7	13.7	180
185										9.7			13.2			13.1	13.1	13.3	185
190													12.7			12.7	12.8	12.6	190
195													9.9			12.3	12.4		195
200													5.8			11.6			200
205																10.3			205
210																8.5			210

t 259_107_20151 / 40151_00_000

Lifting capacities

Forces de levage

TVNZK

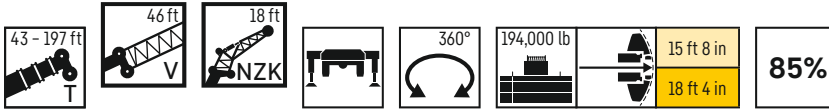

	170 ft + 46 ft			180 ft + 46 ft			184 ft + 46 ft			194 ft + 46 ft			197 ft + 46 ft			
	18 ft															
	0°	22,5°	45°	0°	22,5°	45°	0°	22,5°	45°	0°	22,5°	45°	0°	22,5°	45°	
45	28.6															45
50	27.9	27		23.6			24			19.8			19.4			50
55	27.1	26.4	25.9	23.2	22.7		23.6	23.1		19.5			19.2			55
60	26.4	25.7	25.3	22.7	22.3	22.1	23.1	22.6	22.4	19.2	19.1		18.9	18.7		60
65	25.6	25	24.6	22.2	21.8	21.7	22.6	22.2	22	18.9	18.8	18.7	18.6	18.5	18.5	65
70	24.8	24.3	24	21.6	21.3	21.2	22	21.7	21.5	18.5	18.5	18.5	18.3	18.2	18.2	70
75	24	23.6	23.3	21.1	20.8	20.7	21.5	21.2	21.1	18.2	18.1	18.2	17.9	17.9	17.9	75
80	23.3	23	22.7	20.6	20.3	20	21	20.7	20.6	17.8	17.8	17.8	17.6	17.6	17.6	80
85	22.6	22.3	22.1	20	19.7	19.4	20.4	20.3	20.1	17.5	17.5	17.5	17.3	17.2	17.3	85
90	21.9	21.7	21.5	19.4	19.1	18.8	19.9	19.7	19.5	17.1	17.1	17.1	16.9	16.9	16.9	90
95	21.2	21.1	21	18.9	18.4	18.2	19.4	19.2	18.9	16.8	16.7	16.7	16.6	16.5	16.5	95
100	20.6	20.6	20.5	18.3	17.9	17.6	19	18.6	18.3	16.4	16.3	16.3	16.3	16.1	16.2	100
105	20	20	20	17.8	17.3	17.1	18.5	18	17.8	16.1	15.9	15.9	15.9	15.8	15.8	105
110	19.4	19.5	19.5	17.2	16.8	16.6	18	17.5	17.3	15.7	15.6	15.6	15.6	15.4	15.4	110
115	18.9	19	19	16.6	16.3	16.1	17.5	17	16.8	15.4	15.2	15.2	15.2	15.1	15.1	115
120	18.4	18.5	18.6	16	15.8	15.7	17	16.5	16.3	15	14.8	14.8	14.9	14.7	14.7	120
125	17.9	18	18.1	15.5	15.3	15.3	16.5	16	15.9	14.6	14.4	14.4	14.5	14.3	14.4	125
130	17.5	17.5	17.7	15	14.8	14.8	16	15.6	15.5	14.3	14	14.1	14.2	14	14	130
135	17	17.1	17.3	14.5	14.4	14.4	15.5	15.2	15.1	13.9	13.7	13.7	13.8	13.6	13.6	135
140	16.6	16.7	17	14.1	13.9	13.9	15.1	14.8	14.7	13.5	13.3	13.3	13.4	13.3	13.3	140
145	16.2	16.3	16.6	13.6	13.5	13.5	14.6	14.4	14.3	13.1	12.9	13	13.1	12.9	12.9	145
150	15.8	15.9	16.2	13.2	13.1	13.1	14.2	14	14	12.7	12.6	12.6	12.7	12.6	12.6	150
155	15.5	15.6	15.9	12.8	12.7	12.7	13.8	13.6	13.6	12.4	12.3	12.3	12.3	12.2	12.2	155
160	15.1	15.3	15.5	12.3	12.3	12.3	13.4	13.3	13.3	12	11.9	12	12	11.9	11.9	160
165	14.8	15	15.1	11.9	11.9	12	13	12.9	13	11.7	11.6	11.7	11.7	11.6	11.7	165
170	14.5	14.6	14.8	11.4	11.5	11.5	12.7	12.6	12.7	11.4	11.3	11.4	11.4	11.3	11.4	170
175	14.2	14.3	14.4	11	11.1	11.1	12.3	12.3	12.4	11	11	11.1	11	11	11.1	175
180	13.6	13.8	13.9	10.6	10.7	10.7	12	12	12	10.7	10.7	10.7	10.7	10.7	10.8	180
185	12.8	13	13	10.2	10.3	10.3	11.7	11.7	11.8	10.3	10.3	10.4	10.3	10.3	10.4	185
190	12	12.1	12.1	9.8	9.9	9.9	11.4	11.4	11.5	10	10	10.1	10	10	10.1	190
195	11.2	11.3	11.3	9.5	9.5	9.6	11.1	11.1	11.2	9.7	9.7	9.8	9.7	9.7	9.8	195
200	10.5	10.5	10.6	9.1	9.1	9.2	10.7	10.8	10.9	9.3	9.4	9.4	9.4	9.4	9.5	200
205	10.2	10.2		8.8	8.8	8.9	10	10.2	10.2	9	9.1	9.1	9.1	9.1	9.1	205
210	9.9	10		8.5	8.5	8.6	9.4	9.5	9.5	8.7	8.8	8.8	8.8	8.8	8.8	210
215	9.7			8.2	8.2		8.7	8.8	8.8	8.4	8.5	8.5	8.5	8.5	8.6	215
220	8.2			7.9			8.1	8.2		8.2	8.2	8.3	8.1	8.2	8.2	220
225	5.6			7.7			7.6			7.7	7.7		7.5	7.6	7.6	225
230				6.9			7			7.2	7.3		7.1	7.1		230
235				4.5			5.4			6.8	6.8		6.6	6.7		235
240							2.7			6.1			6.2			240
245										4.5			5			245
250													2.9			250

t_259_107_20151 / 40151_00_000

Lifting capacities

Forces de levage

TVNZK

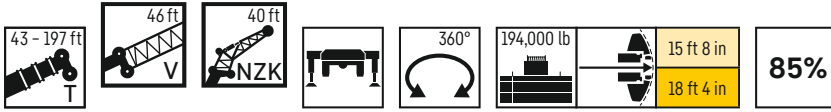

	43 ft + 46 ft			99 ft + 46 ft			114 ft + 46 ft			128 ft + 46 ft			142 ft + 46 ft			156 ft + 46 ft			
	0°	22,5°	45°	0°	22,5°	45°	0°	22,5°	45°	0°	22,5°	45°	0°	22,5°	45°	0°	22,5°	45°	
15	38.1																		15
16	38.1																		16
17	38																		17
18	37.5																		18
19	37.1																		19
20	36.6																		20
22	35.6																		22
24	34.5																		24
26	33.4																		26
28	32.2			37.5															28
30	31.1	28.7		36.8			35.5												30
32	30.1	28.3		36.2			35												32
34	29	27.5		35.5			34.4			32.4									34
36	28.1	26.6		34.7			33.8			31.9			29.2						36
38	27.1	25.7		33.9			33.1			31.4			28.9						38
40	26.3	24.9		33.1			32.5			30.9			28.6						40
45	24.2	23	22	31.2	27.5		30.8	27.1		29.6			27.6			24.9			45
50	22.4	21.4	20.6	29.3	26		29.2	25.9		28.2	25.1		26.5			24.2			50
55	20.7	19.9	19.3	27.7	24.6	22.3	27.7	24.6	22	27	24.1		25.5	23		23.4			55
60	19.3	18.6	18.1	26.1	23.3	21.3	26.3	23.4	21.2	25.7	23	20.8	24.5	22.1		22.7	20.8		60
65	17.9	17.4	17.1	24.7	22.1	20.4	25	22.3	20.3	24.5	22	20	23.5	21.3	19.4	21.9	20.1		65
70	16.8	16.3	16.1	23.4	21.1	19.5	23.7	21.3	19.5	23.4	21.1	19.3	22.6	20.5	18.8	21.2	19.4	17.9	70
75	15.7	15.4	15.2	22.1	20.1	18.7	22.6	20.3	18.8	22.4	20.2	18.6	21.7	19.7	18.2	20.4	18.8	17.4	75
80	14.7	14.5	14.4	21	19.1	18	21.5	19.5	18.1	21.4	19.4	18	20.9	19	17.6	19.8	18.1	16.9	80
85	13.9	13.7	13.6	20	18.3	17.3	20.5	18.6	17.5	20.5	18.6	17.4	20	18.3	17	19.1	17.5	16.4	85
90	13	13	13	19	17.5	16.6	19.6	17.8	16.8	19.6	17.9	16.8	19.2	17.6	16.5	18.5	17	15.9	90
95	12.3	12.3	12.4	18	16.8	16	18.7	17.1	16.3	18.8	17.2	16.3	18.5	17	16	17.8	16.4	15.5	95
100	11.7	11.6	11.8	17.2	16.1	15.4	17.8	16.4	15.7	18.1	16.6	15.8	17.8	16.4	15.6	17.2	15.9	15.1	100
105	11	11	11.3	16.4	15.4	14.8	17.1	15.8	15.2	17.4	16	15.3	17.2	15.9	15.1	16.6	15.4	14.7	105
110	10.4	10.5	10.8	15.7	14.8	14.3	16.4	15.2	14.7	16.7	15.4	14.8	16.6	15.4	14.7	16.1	15	14.3	110
115	9.9	10	6.9	15	14.2	13.8	15.7	14.7	14.2	16	14.9	14.4	16	14.9	14.3	15.6	14.5	14	115
120	9.5	9.6		14.4	13.7	13.4	15.1	14.2	13.8	15.4	14.4	13.9	15.4	14.4	13.9	15.1	14.1	13.6	120
125				13.8	13.2	13	14.5	13.7	13.4	14.8	13.9	13.6	14.9	14	13.5	14.6	13.7	13.3	125
130				13.2	12.7	12.6	13.9	13.2	13	14.3	13.5	13.2	14.4	13.6	13.2	14.1	13.4	13	130
135				12.7	12.3	12.2	13.4	12.8	12.6	13.8	13.1	12.8	13.9	13.1	12.9	13.7	13	12.7	135
140				12.2	11.8	11.9	12.9	12.4	12.3	13.3	12.7	12.5	13.5	12.8	12.5	13.3	12.6	12.4	140
145				11.8	11.4	11.5	12.4	12	12	12.9	12.3	12.2	13	12.4	12.2	12.9	12.3	12.1	145
150				11.3	11	11.2	12	11.6	11.6	12.4	11.9	11.9	12.6	12.1	12	12.5	12	11.8	150
155				10.9	10.7		11.6	11.2	11.3	12	11.6	11.6	12.3	11.8	11.7	12.2	11.7	11.6	155
160				10.5	10.4		11.2	10.9	11	11.6	11.2	11.3	11.9	11.4	11.4	11.9	11.4	11.4	160
165				10.1	10		10.7	10.5	10.8	11.2	10.9	11	11.5	11.1	11.1	11.5	11.1	11.1	165
170				9.8	9.8		10.4	10.2		10.9	10.6	10.8	11.2	10.8	10.9	11.2	10.8	10.9	170
175				9.5	9.6		10.1	10		10.5	10.3	10.5	10.9	10.5	10.7	10.9	10.5	10.6	175
180				8.4			9.8	9.7		10.2	10		10.5	10.2	10.5	10.6	10.3	10.4	180
185							9.5	9.6		9.9	9.8		10.2	10	10.3	10.3	10.1	10.3	185
190							9.3			9.7	9.6		10	9.8		10.1	9.8	10.1	190
195										9.4	9.4		9.7	9.6		9.8	9.6	10	195
200										9.2	9.3		9.5	9.4		9.6	9.5	9.8	200
205										7.2			9.3	9.2		9.4	9.3		205
210													9	9.2		9.1	9.2		210
215													8.2	9		8.9	8.9		215
220													7			8.8	8.9		220
225																8.2	8.8		225
230																7.1			230
235																4.3			235

t.259.107.21151 / 41151.00.000

Lifting capacities

Forces de levage

TVNZK

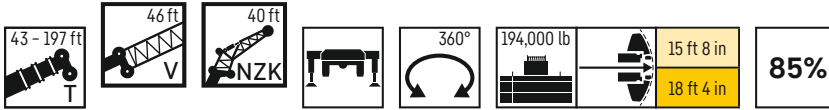

	170 ft + 46 ft			180 ft + 46 ft			184 ft + 46 ft			194 ft + 46 ft			197 ft + 46 ft			
	0°	22,5°	45°	0°	22,5°	45°	0°	22,5°	45°	0°	22,5°	45°	0°	22,5°	45°	
45	20.5															45
50	20.1			16.7			17									50
55	19.7			16.4			16.7			15.1			14.8			55
60	19.2	18		16.1			16.5			14.9			14.6			60
65	18.7	17.7		15.8	15.2		16.1	15.5		14.7			14.4			65
70	18.2	17.2		15.5	14.9		15.8	15.2		14.4	13.9		14.2	13.7		70
75	17.7	16.8	15.8	15.2	14.6		15.5	14.9		14.2	13.7		13.9	13.5		75
80	17.3	16.3	15.4	14.9	14.3	13.7	15.2	14.6	13.9	13.9	13.5		13.7	13.3		80
85	16.8	15.9	15.1	14.5	14	13.5	14.8	14.2	13.7	13.6	13.2	12.8	13.5	13	12.6	85
90	16.3	15.4	14.7	14.2	13.7	13.2	14.5	13.9	13.4	13.4	13	12.6	13.2	12.8	12.4	90
95	15.9	15	14.3	13.9	13.4	12.9	14.1	13.6	13.1	13.1	12.7	12.3	12.9	12.6	12.2	95
100	15.4	14.6	14	13.6	13.1	12.6	13.8	13.3	12.9	12.9	12.4	12.1	12.7	12.3	12	100
105	15	14.3	13.7	13.3	12.7	12.2	13.5	13	12.6	12.6	12.2	11.9	12.5	12.1	11.8	105
110	14.6	13.9	13.4	13	12.3	11.8	13.2	12.7	12.3	12.3	12	11.6	12.2	11.9	11.6	110
115	14.2	13.5	13.1	12.6	11.9	11.5	12.9	12.4	11.9	12.1	11.7	11.3	12	11.6	11.3	115
120	13.8	13.2	12.8	12.3	11.6	11.2	12.6	12	11.6	11.8	11.4	11	11.7	11.3	11	120
125	13.4	12.9	12.6	12	11.2	10.9	12.3	11.7	11.3	11.6	11.1	10.7	11.5	11	10.7	125
130	13.1	12.5	12.3	11.6	10.9	10.6	12	11.3	11	11.3	10.8	10.5	11.2	10.7	10.4	130
135	12.7	12.2	12	11.3	10.6	10.3	11.7	11	10.7	11.1	10.5	10.2	11	10.4	10.2	135
140	12.4	12	11.8	10.9	10.3	10	11.4	10.7	10.4	10.8	10.2	10	10.8	10.2	9.9	140
145	12.1	11.7	11.6	10.6	10	9.8	11.1	10.4	10.2	10.6	9.9	9.7	10.5	9.9	9.7	145
150	11.8	11.5	11.4	10.3	9.7	9.5	10.8	10.1	9.9	10.3	9.7	9.5	10.2	9.6	9.5	150
155	11.5	11.2	11.1	10	9.5	9.3	10.5	9.9	9.7	10	9.4	9.3	10	9.4	9.2	155
160	11.2	11	10.9	9.7	9.2	9.1	10.2	9.6	9.5	9.7	9.2	9.1	9.7	9.2	9	160
165	10.9	10.8	10.8	9.4	9	8.9	9.9	9.4	9.2	9.5	9	8.9	9.4	9	8.8	165
170	10.7	10.5	10.6	9.2	8.7	8.7	9.6	9.1	9	9.2	8.8	8.7	9.2	8.7	8.7	170
175	10.5	10.3	10.4	8.9	8.5	8.5	9.4	8.9	8.8	9	8.6	8.5	9	8.5	8.5	175
180	10.2	10.1	10.3	8.7	8.3	8.3	9.1	8.7	8.7	8.7	8.4	8.3	8.7	8.4	8.3	180
185	10	9.9	10.1	8.4	8.1	8.2	8.9	8.5	8.5	8.5	8.2	8.2	8.5	8.2	8.2	185
190	9.8	9.8	10	8.2	7.9	8	8.7	8.3	8.3	8.3	8	8	8.3	8	8	190
195	9.6	9.6	9.8	8	7.8	7.8	8.4	8.1	8.2	8.1	7.8	7.8	8.1	7.8	7.9	195
200	9.4	9.4	9.7	7.8	7.6	7.7	8.2	8	8	7.9	7.7	7.7	7.9	7.7	7.7	200
205	9.2	9.2	9.5	7.6	7.5	7.6	8.1	7.8	7.9	7.6	7.5	7.6	7.7	7.5	7.6	205
210	9.1	9.1	9.4	7.3	7.3	7.4	7.9	7.7	7.8	7.5	7.4	7.5	7.5	7.4	7.5	210
215	8.7	8.9	9.2	7.1	7.1	7.3	7.7	7.5	7.7	7.3	7.3	7.4	7.3	7.3	7.4	215
220	8.2	8.6		6.9	6.9	7.1	7.6	7.4	7.6	7.1	7.1	7.2	7.1	7.1	7.2	220
225	7.6	8		6.7	6.7	6.8	7.4	7.3	7.5	6.9	7	7	6.9	6.9	7	225
230	7.2	7.4		6.4	6.5		7.3	7.2	7.5	6.7	6.8	6.8	6.7	6.8	6.9	230
235	7.1	7.1		6.2	6.3		6.9	7.2		6.5	6.6	6.6	6.5	6.6	6.7	235
240	6.7	7.1		6.1	6.1		6.5	6.7		6.3	6.4		6.2	6.4	6.5	240
245	4.9			5.9	5.9		6.1	6.3		6	6.2		5.8	6.1		245
250				5.5			5.6	5.9		5.6	5.8		5.4	5.7		250
255				3.9			4.3			5.2	5.4		5.1	5.3		255
260										4.7	5		4.7	4.9		260
265										3.2			3.6			265

t 259_107_21151 / 41151_00_000

Lifting capacities

Forces de levage

TVNZK

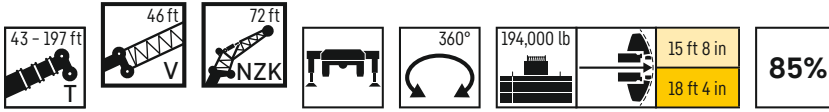

	43 ft + 46 ft			99 ft + 46 ft			114 ft + 46 ft			128 ft + 46 ft			142 ft + 46 ft			156 ft + 46 ft			
	0°	22,5°	45°	0°	22,5°	45°	0°	22,5°	45°	0°	22,5°	45°	0°	22,5°	45°	0°	22,5°	45°	
20	16.3																		20
22	16.8																		22
24	16.8																		24
26	16.7																		26
28	16.7																		28
30	16.6			16.9															30
32	16.5			16.8															32
34	16.5			16.8			16.3												34
36	16.4			16.8			16.2			15.5									36
38	16.3			16.7			16.2			15.5									38
40	16.2			16.7			16.1			15.4			14.5						40
45	15.8			16.5			16			15.3			14.4			13.3			45
50	15.2	14.3		16.4			15.9			15.2			14.3			13.2			50
55	14.6	13.9		16.2			15.7			15.1			14.2			13.1			55
60	13.9	13.4		16	14.4		15.6			15			14.1			13.1			60
65	13.2	13		15.6	14		15.4	13.9		14.8			14.1			13			65
70	12.5	12.5	10.8	15.2	13.7		15	13.6		14.6	13.4		13.9			12.9			70
75	11.9	11.9	10.5	14.7	13.4		14.6	13.3		14.2	13.1		13.6	12.8		12.8			75
80	11.2	11.2	10.4	14.2	13.1	10.8	14.1	13		13.8	12.9		13.3	12.5		12.5	11.8		80
85	10.7	10.7	10.2	13.7	12.8	10.6	13.7	12.7	10.6	13.4	12.5		12.9	12.2		12.2	11.5		85
90	10.1	10.1	10	13.2	12.3	10.5	13.2	12.3	10.5	13	12.2	10.4	12.6	11.8	10.2	11.9	11.2		90
95	9.6	9.6	9.6	12.7	11.9	10.4	12.8	11.9	10.3	12.6	11.8	10.3	12.2	11.4	10.1	11.6	10.9	9.9	95
100	9.1	9.1	9.1	12.2	11.4	10.3	12.3	11.5	10.2	12.2	11.4	10.2	11.9	11.1	10	11.3	10.6	9.8	100
105	8.6	8.7	8.7	11.7	11	10.1	11.9	11.1	10.1	11.8	11	10	11.5	10.8	9.9	11	10.3	9.6	105
110	8.2	8.3	8.4	11.2	10.6	10	11.4	10.7	10	11.4	10.7	9.9	11.2	10.5	9.7	10.7	10	9.3	110
115	7.8	7.9	8	10.8	10.2	9.7	11	10.3	9.7	11	10.3	9.6	10.8	10.2	9.4	10.4	9.8	9.1	115
120	7.4	7.5	7.7	10.4	9.8	9.4	10.6	10	9.5	10.7	10	9.4	10.5	9.8	9.2	10.1	9.5	8.9	120
125	7.1	7.2	7.4	10	9.5	9.1	10.2	9.6	9.2	10.3	9.7	9.1	10.2	9.6	9	9.8	9.2	8.7	125
130	6.8	6.9	7.1	9.6	9.1	8.8	9.9	9.3	8.9	10	9.4	8.9	9.9	9.3	8.8	9.6	9	8.5	130
135	6.5	6.6	6.9	9.2	8.8	8.6	9.5	9	8.7	9.6	9.1	8.7	9.6	9	8.5	9.3	8.8	8.3	135
140	6.2	6.4	6.7	8.9	8.5	8.3	9.2	8.7	8.4	9.3	8.8	8.4	9.3	8.7	8.3	9	8.5	8.1	140
145	6	6.2	6.6	8.5	8.2	8.1	8.9	8.4	8.2	9	8.5	8.2	9	8.5	8.1	8.8	8.3	7.9	145
150	5.8	6		8.2	7.9	7.9	8.5	8.2	8	8.7	8.3	8	8.7	8.3	8	8.5	8.1	7.8	150
155	5.6			7.9	7.7	7.7	8.2	7.9	7.8	8.4	8	7.8	8.5	8	7.8	8.3	7.9	7.6	155
160				7.6	7.4	7.5	8	7.7	7.6	8.2	7.8	7.7	8.2	7.8	7.6	8.1	7.7	7.5	160
165				7.4	7.2	7.3	7.7	7.4	7.5	7.9	7.6	7.5	8	7.6	7.5	7.8	7.5	7.4	165
170				7.1	7	7.1	7.4	7.2	7.3	7.7	7.4	7.4	7.7	7.4	7.3	7.6	7.3	7.2	170
175				6.9	6.8	7	7.2	7	7.1	7.4	7.2	7.2	7.5	7.2	7.2	7.4	7.1	7.1	175
180				6.7	6.6	6.8	7	6.9	7	7.2	7	7.1	7.3	7.1	7.1	7.2	7	7	180
185				6.5	6.4	6.7	6.8	6.7	6.9	7	6.8	6.9	7.1	6.9	7	7.1	6.9	6.9	185
190				6.3	6.3		6.6	6.5	6.7	6.8	6.7	6.8	6.9	6.8	6.8	6.9	6.7	6.8	190
195				6.1	6.1		6.4	6.4	6.6	6.6	6.5	6.7	6.7	6.6	6.7	6.7	6.6	6.7	195
200				5.9	6		6.2	6.2		6.4	6.4	6.6	6.6	6.5	6.6	6.6	6.4	6.6	200
205				5.8	5.9		6.1	6.1		6.3	6.2		6.4	6.3	6.5	6.4	6.3	6.5	205
210				5.7			5.9	6		6.1	6.1		6.3	6.2	6.4	6.3	6.2	6.4	210
215							5.8	5.9		6	6		6.1	6.1	6.4	6.1	6.1	6.3	215
220							5.6			5.8	5.9		6	6		6	5.9	6.2	220
225							5.4			5.7	5.8		5.8	5.9		5.9	5.9	6.2	225
230										5.6	5.7		5.7	5.8		5.8	5.8	6.1	230
235										5.5			5.6	5.7		5.7	5.7	6.1	235
240										4.3			5.5	5.6		5.5	5.6		240
245													5.4			5.4	5.5		245
250													4.7			5.4	5.5		250
255																5.3	5.5		255
260																4.8			260
265																3.7			265

t_259_107_23151 / 43151_00_000

Lifting capacities

Forces de levage

TVNZK

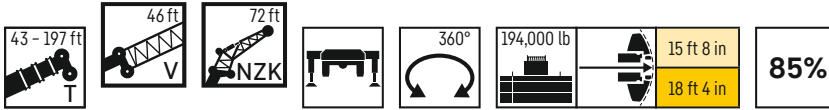

	170 ft + 46 ft			180 ft + 46 ft			184 ft + 46 ft			194 ft + 46 ft			197 ft + 46 ft			
	0°	22,5°	45°	0°	22,5°	45°	0°	22,5°	45°	0°	22,5°	45°	0°	22,5°	45°	
50	11.9															50
55	11.8			10.1			10.3									55
60	11.8			10.1			10.2			9.3			9.2			60
65	11.7			10.1			10.2			9.3			9.1			65
70	11.7			10			10.2			9.3			9.1			70
75	11.6			10			10.1			9.3			9.1			75
80	11.4			9.8			10			9.2			9			80
85	11.1	10.6		9.7	9.1		9.8			9			8.9			85
90	10.9	10.4		9.5	9.1		9.6	9.3		8.9	8.4		8.7	8.1		90
95	10.6	10.1		9.3	9		9.5	9.1		8.7	8.4		8.6	8.1		95
100	10.4	9.9		9.1	8.8		9.3	8.9		8.6	8.3		8.5	8.1		100
105	10.2	9.7	9	9	8.6		9.1	8.7		8.4	8.2		8.3	8		105
110	9.9	9.4	8.8	8.8	8.4	8	8.9	8.6	8.1	8.3	8	7.5	8.2	7.9		110
115	9.7	9.2	8.6	8.6	8.2	7.9	8.7	8.4	8	8.1	7.9	7.5	8	7.8	7.3	115
120	9.4	9	8.4	8.4	8.1	7.7	8.5	8.2	7.8	8	7.7	7.4	7.9	7.6	7.3	120
125	9.2	8.7	8.3	8.2	7.9	7.6	8.4	8	7.7	7.8	7.6	7.3	7.8	7.5	7.3	125
130	9	8.5	8.1	8	7.7	7.5	8.2	7.8	7.5	7.7	7.4	7.2	7.6	7.4	7.2	130
135	8.8	8.3	7.9	7.9	7.5	7.3	8	7.7	7.4	7.5	7.3	7.1	7.5	7.3	7.1	135
140	8.5	8.1	7.8	7.7	7.4	7.1	7.8	7.5	7.3	7.4	7.2	7	7.4	7.1	7	140
145	8.3	7.9	7.6	7.5	7.2	7	7.7	7.4	7.2	7.3	7.1	6.9	7.2	7	6.9	145
150	8.1	7.7	7.5	7.4	7	6.8	7.5	7.2	7	7.1	6.9	6.7	7.1	6.9	6.7	150
155	7.9	7.6	7.4	7.2	6.8	6.7	7.4	7.1	6.9	7	6.8	6.6	7	6.7	6.6	155
160	7.7	7.4	7.3	7.1	6.7	6.5	7.2	6.9	6.7	6.9	6.6	6.5	6.8	6.6	6.4	160
165	7.5	7.2	7.1	6.9	6.5	6.4	7.1	6.7	6.6	6.8	6.5	6.3	6.7	6.4	6.3	165
170	7.4	7.1	7	6.7	6.3	6.2	6.9	6.6	6.4	6.6	6.3	6.2	6.6	6.3	6.2	170
175	7.2	6.9	6.9	6.6	6.2	6.1	6.8	6.4	6.3	6.5	6.2	6.1	6.5	6.2	6.1	175
180	7	6.8	6.8	6.4	6.1	6	6.7	6.3	6.2	6.4	6	6	6.4	6	6	180
185	6.9	6.7	6.7	6.3	5.9	5.9	6.5	6.1	6.1	6.3	5.9	5.9	6.2	5.9	5.8	185
190	6.7	6.5	6.6	6.1	5.8	5.8	6.3	6	6	6.1	5.8	5.7	6.1	5.8	5.7	190
195	6.6	6.4	6.5	5.9	5.7	5.6	6.2	5.9	5.8	6	5.7	5.6	6	5.7	5.6	195
200	6.4	6.3	6.4	5.8	5.5	5.5	6.1	5.7	5.7	5.8	5.5	5.6	5.8	5.6	5.5	200
205	6.3	6.2	6.3	5.7	5.4	5.4	5.9	5.6	5.6	5.7	5.4	5.5	5.7	5.4	5.5	205
210	6.2	6.1	6.3	5.5	5.3	5.4	5.8	5.5	5.6	5.6	5.3	5.4	5.6	5.3	5.4	210
215	6.1	6	6.2	5.4	5.2	5.3	5.7	5.4	5.5	5.5	5.2	5.3	5.5	5.2	5.3	215
220	5.9	5.9	6.1	5.3	5.1	5.2	5.5	5.3	5.4	5.4	5.2	5.2	5.4	5.1	5.2	220
225	5.8	5.8	6.1	5.2	5	5.1	5.4	5.2	5.3	5.2	5.1	5.1	5.2	5	5.1	225
230	5.7	5.7	6	5.1	4.9	5	5.3	5.1	5.2	5.1	5	5.1	5.1	5	5	230
235	5.6	5.6	6	5	4.8	5	5.2	5	5.2	5	4.9	5	5	4.9	5	235
240	5.5	5.5	5.9	4.9	4.8	4.9	5.1	5	5.1	4.9	4.8	4.9	4.9	4.8	4.9	240
245	5.4	5.5	5.9	4.8	4.7	4.9	5	4.9	5.1	4.8	4.7	4.9	4.9	4.7	4.9	245
250	5.3	5.4	5.9	4.7	4.6	4.9	4.9	4.8	5	4.8	4.7	4.9	4.8	4.7	4.8	250
255	5.3	5.4		4.6	4.6	4.8	4.8	4.8	5	4.7	4.6	4.8	4.7	4.6	4.8	255
260	5.2	5.3		4.5	4.5		4.7	4.7	5	4.6	4.5	4.8	4.6	4.5	4.8	260
265	4.9	5.2		4.4	4.5		4.7	4.6	5	4.5	4.5	4.8	4.5	4.5	4.8	265
270	4.5	4.9		4.3	4.4		4.6	4.6		4.4	4.5	4.7	4.3	4.4	4.7	270
275	3.6			4.2	4.3		4.3	4.6		4.1	4.4		4	4.4		275
280				3.9	4.1		3.8	4.3		3.8	4.2		3.6	4.1		280
285				2.5			2.6	3.7		3.4	3.8		3.2	3.7		285
290										2.8	3.4		2.8	3.3		290
295														2.8		295

t_259_107_23151 / 43151_00_000

Lifting heights

Hauteurs de levage

TVNZK

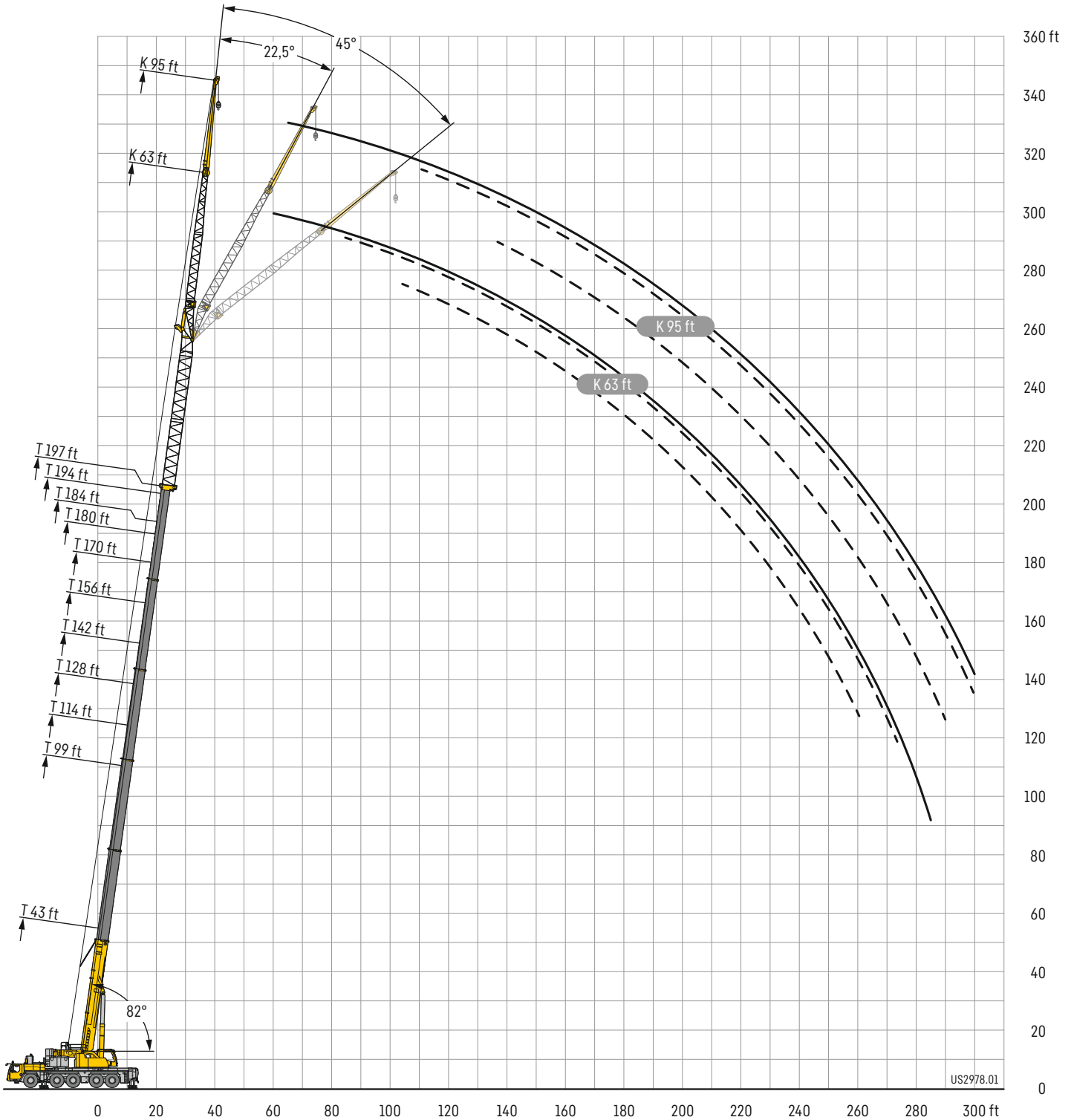

Lifting capacities

Forces de levage

TVNZK

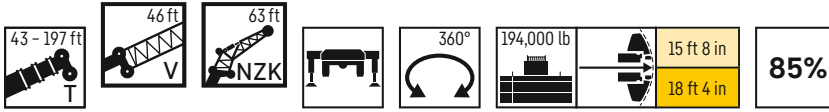

	43 ft + 46 ft			99 ft + 46 ft			114 ft + 46 ft			128 ft + 46 ft			142 ft + 46 ft			156 ft + 46 ft			
	0°	22,5°	45°	0°	22,5°	45°	0°	22,5°	45°	0°	22,5°	45°	0°	22,5°	45°	0°	22,5°	45°	
20	25.8																		20
22	25.8																		22
24	25.6																		24
26	25.1																		26
28	24.5																		28
30	23.9																		30
32	23.3			25.8															32
34	22.7			25.6		24.5													34
36	22.1			25.4		24.3			21.7										36
38	21.5			24.9		24.1			21.7										38
40	20.9			24.5		23.8			21.6				19.8						40
45	19.5	18.4		23.4		22.9			21.1				19.5			17.5			45
50	18.2	17.3		22.3		21.9			20.4				19			17.3			50
55	16.9	16.2		21.2		21			19.7				18.5			16.9			55
60	15.8	15.2		20.2	17.7		20	17.5	19				17.9			16.4			60
65	14.8	14.3	13.6	19.2	16.9		19.1	16.8	18.3	16.3			17.3			16			65
70	13.8	13.4	12.9	18.2	16.1		18.3	16.1	17.6	15.7			16.8	15.1		15.5	14.1		70
75	12.9	12.6	12.2	17.3	15.4	13.8	17.5	15.4	13.6	16.9	15.2		16.2	14.6		15.1	13.7		75
80	12.2	11.9	11.6	16.5	14.7	13.3	16.7	14.8	13.2	16.3	14.6	13.1	15.6	14.1		14.6	13.3		80
85	11.4	11.2	11	15.6	14.1	12.8	15.9	14.2	12.7	15.6	14	12.7	15.1	13.6	12.3	14.1	12.9		85
90	10.7	10.6	10.4	14.9	13.5	12.3	15.2	13.6	12.3	15	13.5	12.3	14.5	13.2	11.9	13.7	12.5	11.4	90
95	10.1	10	9.9	14.2	12.9	11.9	14.5	13.1	11.9	14.4	13	11.9	14	12.7	11.6	13.3	12.1	11.1	95
100	9.5	9.4	9.5	13.6	12.3	11.5	13.9	12.5	11.5	13.8	12.6	11.5	13.5	12.3	11.3	12.9	11.8	10.8	100
105	8.9	8.9	9	12.9	11.8	11.1	13.3	12	11.1	13.3	12.1	11.2	13	11.9	11	12.5	11.4	10.5	105
110	8.4	8.4	8.6	12.3	11.3	10.7	12.7	11.6	10.8	12.8	11.7	10.9	12.6	11.5	10.7	12.1	11.1	10.3	110
115	7.9	8	8.2	11.8	10.9	10.3	12.2	11.1	10.5	12.4	11.3	10.6	12.1	11.2	10.4	11.7	10.8	10	115
120	7.5	7.6	7.8	11.3	10.5	10	11.7	10.7	10.1	11.9	10.9	10.3	11.7	10.8	10.1	11.3	10.5	9.8	120
125	7.2	7.2	7.4	10.8	10.1	9.7	11.2	10.3	9.8	11.4	10.6	10	11.3	10.5	9.9	11	10.1	9.6	125
130	6.9	6.9	7.2	10.3	9.7	9.4	10.7	10	9.5	11	10.2	9.7	11	10.1	9.6	10.6	9.9	9.3	130
135	6.6	6.7	6.9	9.8	9.3	9.1	10.3	9.6	9.2	10.6	9.9	9.5	10.6	9.8	9.4	10.3	9.6	9.1	135
140	6.3	6.5		9.4	8.9	8.8	9.9	9.3	9	10.2	9.6	9.2	10.2	9.5	9.1	10	9.3	8.9	140
145	6.2			9	8.6	8.5	9.5	8.9	8.7	9.9	9.3	9	9.9	9.3	8.9	9.7	9.1	8.7	145
150				8.6	8.2	8.2	9.1	8.6	8.4	9.5	9	8.7	9.6	9	8.7	9.4	8.8	8.5	150
155				8.2	7.9	8	8.7	8.3	8.2	9.2	8.7	8.5	9.3	8.7	8.5	9.1	8.6	8.3	155
160				7.9	7.7	7.7	8.3	8	8	8.9	8.4	8.3	9	8.5	8.3	8.9	8.3	8.2	160
165				7.6	7.4	7.5	8	7.7	7.8	8.6	8.2	8.1	8.7	8.2	8.1	8.6	8.1	8	165
170				7.3	7.2	7.4	7.8	7.5	7.6	8.3	7.9	7.9	8.4	8	8	8.4	7.9	7.8	170
175				7.1	7		7.5	7.3	7.4	8	7.7	7.8	8.2	7.8	7.8	8.1	7.7	7.7	175
180				6.9	6.8		7.2	7.1	7.3	7.8	7.5	7.6	7.9	7.6	7.6	7.9	7.5	7.6	180
185				6.7	6.7		7	6.9		7.5	7.3	7.4	7.7	7.4	7.5	7.7	7.4	7.4	185
190				6.5	6.5		6.8	6.8		7.3	7.1	7.3	7.4	7.2	7.3	7.5	7.2	7.3	190
195				6.3	6.4		6.6	6.6		7.1	7	7.2	7.2	7.1	7.2	7.3	7	7.2	195
200				6.2			6.4	6.5		6.9	6.8		7.1	6.9	7.1	7.1	6.9	7.1	200
205							6.3	6.4		6.7	6.7		6.9	6.8	7	6.9	6.8	7	205
210							6.2	6.3		6.6	6.5		6.7	6.6		6.8	6.6	6.9	210
215							6.1			6.4	6.4		6.6	6.5		6.6	6.5	6.8	215
220										6.2	6.3		6.4	6.4		6.5	6.4	6.7	220
225										6.1	6.3		6.3	6.3		6.3	6.3	6.7	225
230										5.1			6.2	6.2		6.2	6.2		230
235													6.1	6.2		6.1	6.2		235
240													5.3			6	6.1		240
245													3.3			5.9	6		245
250																5.6	6		250
255																4.5			255

t_259_107_22151 / 42151_00_000

Lifting capacities

Forces de levage

TVNZK

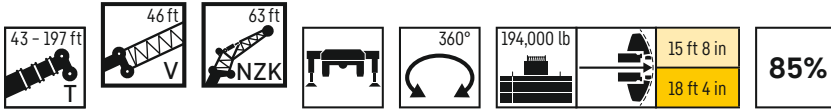

	170 ft + 46 ft			180 ft + 46 ft			184 ft + 46 ft			194 ft + 46 ft			197 ft + 46 ft			
	0°	22,5°	45°	0°	22,5°	45°	0°	22,5°	45°	0°	22,5°	45°	0°	22,5°	45°	
50	15.1															50
55	14.9			12.4			12.6									55
60	14.5			12.2			12.4			11.2			11			60
65	14.2			12			12.2			11			10.8			65
70	13.9			11.7			12			10.9			10.7			70
75	13.5	12.5		11.5			11.7			10.7			10.5			75
80	13.2	12.2		11.3	10.6		11.5			10.5			10.3			80
85	12.9	11.9		11	10.4		11.3	10.6		10.3	9.8		10.1	9.7		85
90	12.5	11.6		10.8	10.2		11	10.4		10.1	9.6		10	9.5		90
95	12.2	11.3	10.4	10.6	10		10.8	10.1		9.9	9.4		9.8	9.3		95
100	11.8	11	10.2	10.3	9.7	9.2	10.5	9.9	9.3	9.7	9.3		9.6	9.1		100
105	11.5	10.7	9.9	10.1	9.5	9	10.3	9.7	9.1	9.5	9.1	8.6	9.4	9	8.5	105
110	11.2	10.4	9.7	9.9	9.3	8.8	10.1	9.5	8.9	9.3	8.9	8.5	9.2	8.8	8.4	110
115	10.9	10.1	9.5	9.6	9.1	8.7	9.8	9.3	8.8	9.1	8.7	8.3	9	8.6	8.2	115
120	10.6	9.9	9.3	9.4	8.9	8.5	9.6	9.1	8.6	8.9	8.5	8.2	8.8	8.4	8.1	120
125	10.3	9.6	9.1	9.2	8.6	8.2	9.4	8.9	8.4	8.7	8.3	8	8.7	8.3	7.9	125
130	10	9.4	8.9	9	8.4	8	9.1	8.6	8.2	8.6	8.2	7.9	8.5	8.1	7.8	130
135	9.7	9.1	8.7	8.7	8.1	7.8	8.9	8.4	8	8.4	8	7.7	8.3	7.9	7.6	135
140	9.5	8.9	8.6	8.5	7.8	7.6	8.7	8.1	7.8	8.2	7.8	7.5	8.1	7.7	7.5	140
145	9.2	8.7	8.4	8.3	7.6	7.4	8.5	7.9	7.6	8	7.6	7.3	8	7.5	7.3	145
150	9	8.5	8.2	8.1	7.4	7.2	8.3	7.7	7.5	7.9	7.4	7.2	7.8	7.4	7.1	150
155	8.7	8.3	8	7.8	7.2	7	8.1	7.5	7.3	7.7	7.2	7	7.6	7.2	7	155
160	8.5	8.1	7.9	7.6	7	6.9	7.9	7.3	7.1	7.5	7	6.9	7.5	7	6.9	160
165	8.3	7.9	7.7	7.3	6.9	6.7	7.6	7.1	7	7.3	6.9	6.7	7.3	6.8	6.7	165
170	8.1	7.7	7.6	7.1	6.7	6.6	7.4	7	6.8	7.1	6.7	6.6	7.1	6.7	6.6	170
175	7.8	7.5	7.5	7	6.6	6.5	7.3	6.8	6.7	7	6.6	6.5	7	6.5	6.4	175
180	7.6	7.4	7.4	6.8	6.4	6.3	7.1	6.7	6.6	6.8	6.4	6.3	6.8	6.4	6.3	180
185	7.5	7.2	7.2	6.6	6.3	6.2	6.9	6.5	6.5	6.6	6.3	6.2	6.6	6.3	6.2	185
190	7.3	7.1	7.1	6.4	6.1	6.1	6.7	6.4	6.3	6.5	6.1	6.1	6.5	6.1	6.1	190
195	7.1	6.9	7	6.3	6	6	6.6	6.2	6.2	6.3	6	6	6.3	6	6	195
200	7	6.8	6.9	6.1	5.9	5.9	6.4	6.1	6.1	6.2	5.9	5.9	6.2	5.9	5.9	200
205	6.8	6.7	6.8	6	5.7	5.8	6.3	6	6	6	5.8	5.8	6.1	5.8	5.8	205
210	6.7	6.5	6.8	5.8	5.6	5.7	6.1	5.9	5.9	5.9	5.7	5.7	5.9	5.7	5.7	210
215	6.5	6.4	6.7	5.7	5.5	5.6	6	5.8	5.8	5.8	5.6	5.6	5.8	5.6	5.6	215
220	6.4	6.3	6.6	5.6	5.4	5.5	5.8	5.6	5.7	5.7	5.5	5.5	5.7	5.5	5.5	220
225	6.3	6.2	6.6	5.5	5.3	5.4	5.7	5.5	5.7	5.5	5.4	5.5	5.6	5.4	5.5	225
230	6.2	6.2	6.5	5.4	5.2	5.4	5.6	5.5	5.6	5.4	5.3	5.4	5.5	5.3	5.4	230
235	6.1	6.1	6.5	5.3	5.2	5.4	5.5	5.4	5.5	5.3	5.2	5.3	5.4	5.2	5.3	235
240	6	6	6.5	5.2	5.1	5.3	5.4	5.3	5.5	5.2	5.1	5.3	5.3	5.1	5.3	240
245	5.9	5.9		5.1	5	5.3	5.3	5.2	5.4	5.1	5	5.2	5.2	5	5.2	245
250	5.7	5.9		4.9	5		5.2	5.1	5.4	5.1	5	5.2	5	5	5.2	250
255	5.3	5.6		4.8	4.9		5.1	5.1		5	4.9	5.1	4.9	4.9	5.1	255
260	5	5.2		4.6	4.7		5	5		4.8	4.9	5	4.8	4.9	5	260
265	4.3	5		4.5			4.7	5		4.6	4.8		4.4	4.7		265
270				4.3			4.3	4.7		4.2	4.6		4	4.4		270
275				3.3			3.3	4.2		3.8			3.6	4		275
280										3.4			3.2			280
285													2.4			285

t_259_107_22151 / 42151_00_000

Lifting capacities

Forces de levage

TVNZK

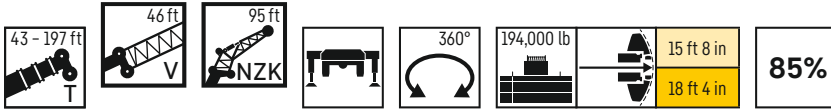

	43 ft + 46 ft			99 ft + 46 ft			114 ft + 46 ft			128 ft + 46 ft			142 ft + 46 ft			156 ft + 46 ft			
	0°	22,5°	45°	0°	22,5°	45°	0°	22,5°	45°	0°	22,5°	45°	0°	22,5°	45°	0°	22,5°	45°	
24	12.4																		24
26	12.3																		26
28	12.3																		28
30	12.2																		30
32	12.2																		32
34	12.1																		34
36	12			12.3															36
38	12			12.3			11.8												38
40	11.9			12.2			11.8			11.2									40
45	11.8			12.1			11.7			11.2			10.5						45
50	11.6			12			11.6			11.1			10.4			9.5			50
55	11.4			11.9			11.5			11			10.3			9.5			55
60	11.1			11.8			11.4			10.9			10.2			9.4			60
65	10.6	9.8		11.6			11.3			10.8			10.1			9.3			65
70	10.1	9.4		11.5			11.1			10.7			10			9.3			70
75	9.6	9.1		11.4	9.9		11			10.6			10			9.2			75
80	9.2	8.7		11.1	9.6		10.9	9.5		10.4			9.9			9.1			80
85	8.7	8.4		10.7	9.3		10.6	9.2		10.3	9.1		9.8	8.8		9			85
90	8.2	8.1	6.9	10.3	9		10.3	9		10	8.9		9.6	8.6		9	8.3		90
95	7.8	7.8	6.7	10	8.8		10	8.7		9.7	8.6		9.4	8.4		8.8	8.1		95
100	7.5	7.5	6.6	9.6	8.5	6.9	9.6	8.5		9.4	8.4		9.1	8.2		8.6	7.9		100
105	7.1	7.2	6.5	9.2	8.3	6.8	9.3	8.3	6.7	9.1	8.2		8.8	8		8.4	7.8		105
110	6.8	6.9	6.4	8.9	8.1	6.7	8.9	8.1	6.6	8.8	8	6.6	8.6	7.9	6.5	8.1	7.6		110
115	6.5	6.6	6.3	8.5	7.9	6.6	8.6	7.9	6.6	8.6	7.8	6.5	8.3	7.7	6.4	7.9	7.4	6.3	115
120	6.2	6.3	6.2	8.2	7.7	6.5	8.3	7.7	6.5	8.3	7.7	6.4	8.1	7.5	6.4	7.7	7.2	6.3	120
125	5.9	6.1	6.1	7.9	7.4	6.4	8	7.5	6.4	8	7.4	6.4	7.8	7.3	6.3	7.5	7.1	6.2	125
130	5.6	5.8	5.9	7.6	7.2	6.3	7.7	7.3	6.3	7.7	7.3	6.3	7.6	7.1	6.2	7.3	6.9	6.1	130
135	5.4	5.5	5.7	7.3	7	6.3	7.5	7.1	6.3	7.5	7.1	6.2	7.4	7	6.2	7.1	6.7	6.1	135
140	5.1	5.3	5.5	7	6.8	6.2	7.2	6.9	6.2	7.3	6.9	6.2	7.2	6.8	6.1	7	6.6	6	140
145	4.9	5	5.3	6.8	6.5	6.2	7	6.7	6.1	7	6.7	6.1	7	6.6	6.1	6.8	6.4	6	145
150	4.7	4.8	5.1	6.6	6.3	6.1	6.8	6.5	6.1	6.8	6.5	6.1	6.8	6.4	6	6.6	6.3	5.9	150
155	4.5	4.6	4.9	6.3	6.1	6	6.5	6.3	6	6.6	6.3	6	6.6	6.3	5.9	6.4	6.1	5.8	155
160	4.3	4.5	4.7	6.1	5.9	5.8	6.3	6.1	5.9	6.4	6.1	5.9	6.4	6.1	5.8	6.2	6	5.7	160
165	4.1	4.3	4.6	5.9	5.7	5.7	6.1	5.9	5.8	6.2	5.9	5.8	6.2	5.9	5.7	6.1	5.8	5.6	165
170	4	4.1		5.7	5.6	5.5	5.9	5.7	5.6	6	5.8	5.6	6	5.8	5.6	5.9	5.7	5.5	170
175	3.8	4.1		5.5	5.4	5.4	5.7	5.5	5.5	5.8	5.6	5.5	5.8	5.6	5.5	5.8	5.5	5.4	175
180				5.3	5.2	5.3	5.5	5.4	5.4	5.6	5.5	5.4	5.7	5.5	5.4	5.6	5.4	5.3	180
185				5.1	5	5.1	5.3	5.2	5.2	5.5	5.3	5.3	5.5	5.3	5.3	5.5	5.3	5.2	185
190				4.9	4.9	5	5.1	5.1	5.1	5.3	5.1	5.2	5.4	5.2	5.2	5.3	5.1	5.1	190
195				4.8	4.8	4.9	5	4.9	5	5.2	5	5	5.2	5	5.1	5.2	5	5	195
200				4.6	4.6	4.8	4.8	4.8	4.9	5	4.9	4.9	5.1	4.9	5	5	4.9	4.9	200
205				4.5	4.5	4.7	4.7	4.7	4.8	4.8	4.8	4.9	4.9	4.8	4.9	4.9	4.8	4.8	205
210				4.3	4.4		4.5	4.5	4.7	4.7	4.6	4.8	4.8	4.7	4.8	4.8	4.7	4.7	210
215				4.2	4.2		4.4	4.4	4.6	4.6	4.5	4.7	4.7	4.6	4.7	4.7	4.6	4.6	215
220				4.1	4.1		4.3	4.3		4.4	4.4	4.6	4.5	4.5	4.6	4.5	4.5	4.6	220
225				3.9	4.1		4.2	4.2		4.3	4.3	4.5	4.4	4.4	4.5	4.4	4.4	4.5	225
230				3.8			4.1	4.1		4.2	4.2		4.3	4.3	4.5	4.3	4.3	4.4	230
235				3.8			4	4		4.1	4.1		4.2	4.2	4.4	4.2	4.2	4.4	235
240							3.9			4	4		4.1	4.1	4.4	4.1	4.1	4.3	240
245							3.8			3.9	4		4	4		4	4	4.3	245
250										3.8	3.9		3.9	4		3.9	3.9	4.3	250
255										3.7			3.8	3.9		3.8	3.9	4.3	255
260										3.2			3.7	3.9		3.8	3.8	4.3	260
265													3.7	3.8		3.7	3.8		265
270													3.6			3.6	3.7		270
275													3.1			3.5	3.7		275
280																3.5	3.7		280
285																3.1			285

t 259_107_25151 / 45151_00_000

Lifting capacities

Forces de levage

TVNZK

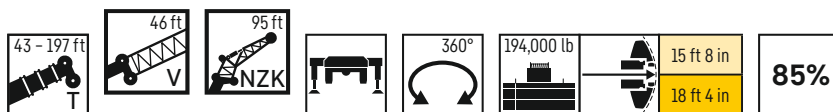

	170 ft + 46 ft			180 ft + 46 ft			184 ft + 46 ft			194 ft + 46 ft			197 ft + 46 ft			
	95 ft															
	0°	22,5°	45°	0°	22,5°	45°	0°	22,5°	45°	0°	22,5°	45°	0°	22,5°	45°	
55	8.5														55	
60	8.4			7.2			7.3								60	
65	8.4			7.2			7.3			6.7			6.5		65	
70	8.3			7.1			7.2			6.6			6.5		70	
75	8.3			7.1			7.2			6.6			6.5		75	
80	8.2			7.1			7.2			6.6			6.5		80	
85	8.1			7.1			7.1			6.5			6.4		85	
90	8.1			7			7.1			6.5			6.4		90	
95	8			6.9			7.1			6.4			6.3		95	
100	7.8	7.5		6.9			7			6.4			6.2		100	
105	7.7	7.3		6.8	6.3		6.9	6.5		6.3	5.7		6.2		105	
110	7.5	7.1		6.7	6.2		6.8	6.5		6.2	5.7		6.1	5.6	110	
115	7.3	7		6.5	6.2		6.6	6.4		6.2	5.7		6.1	5.6	115	
120	7.2	6.8		6.4	6.2		6.5	6.3		6.1	5.7		6	5.6	120	
125	7	6.7	6	6.3	6.1		6.4	6.2		6	5.7		5.9	5.6	125	
130	6.9	6.5	6	6.2	6	5.5	6.3	6	5.6	5.9	5.7		5.8	5.6	130	
135	6.7	6.4	5.9	6	5.9	5.5	6.1	5.9	5.6	5.8	5.6	5	5.7	5.6	4.9	135
140	6.6	6.2	5.9	5.9	5.7	5.4	6	5.8	5.5	5.7	5.5	5	5.6	5.5	4.9	140
145	6.4	6.1	5.8	5.8	5.6	5.4	5.9	5.7	5.4	5.6	5.4	5	5.5	5.4	4.9	145
150	6.3	6	5.7	5.7	5.5	5.3	5.8	5.6	5.3	5.5	5.3	5	5.4	5.3	4.9	150
155	6.1	5.8	5.6	5.6	5.4	5.2	5.7	5.5	5.2	5.4	5.2	5	5.3	5.2	4.9	155
160	6	5.7	5.5	5.5	5.3	5.1	5.5	5.3	5.2	5.2	5.1	5	5.2	5.1	4.9	160
165	5.8	5.6	5.4	5.3	5.2	5	5.4	5.2	5.1	5.1	5	4.9	5.1	5	4.8	165
170	5.7	5.5	5.3	5.2	5	4.9	5.3	5.1	5	5	4.9	4.8	5	4.9	4.8	170
175	5.5	5.3	5.2	5.1	4.9	4.8	5.2	5	4.9	4.9	4.8	4.7	4.9	4.8	4.7	175
180	5.4	5.2	5.1	5	4.8	4.7	5.1	4.9	4.8	4.8	4.7	4.6	4.8	4.7	4.6	180
185	5.3	5.1	5	4.9	4.6	4.6	5	4.8	4.7	4.7	4.6	4.5	4.7	4.6	4.5	185
190	5.2	5	4.9	4.8	4.5	4.4	4.9	4.7	4.6	4.7	4.5	4.4	4.6	4.5	4.4	190
195	5	4.9	4.9	4.6	4.4	4.3	4.8	4.6	4.5	4.6	4.4	4.3	4.5	4.4	4.3	195
200	4.9	4.8	4.8	4.5	4.3	4.2	4.7	4.5	4.4	4.5	4.3	4.2	4.4	4.3	4.2	200
205	4.8	4.7	4.7	4.4	4.2	4.2	4.6	4.4	4.3	4.4	4.2	4.2	4.4	4.2	4.2	205
210	4.7	4.6	4.6	4.3	4.1	4.1	4.4	4.3	4.2	4.3	4.1	4.1	4.3	4.1	4.1	210
215	4.6	4.5	4.6	4.2	4	4	4.4	4.2	4.2	4.2	4	4	4.2	4	4	215
220	4.5	4.4	4.5	4.1	3.9	3.9	4.3	4.1	4.1	4.1	3.9	3.9	4.1	3.9	3.9	220
225	4.3	4.3	4.4	4	3.8	3.8	4.2	4	4	4	3.8	3.8	4	3.8	3.8	225
230	4.2	4.2	4.4	3.9	3.7	3.8	4.1	3.9	3.9	3.9	3.7	3.8	3.9	3.7	3.8	230
235	4.2	4.1	4.3	3.8	3.6	3.7	4	3.8	3.8	3.8	3.7	3.7	3.8	3.7	3.7	235
240	4.1	4	4.2	3.7	3.5	3.6	3.9	3.7	3.8	3.8	3.6	3.7	3.8	3.6	3.6	240
245	4	4	4.2	3.6	3.5	3.6	3.8	3.6	3.7	3.7	3.5	3.6	3.7	3.5	3.6	245
250	3.9	3.9	4.2	3.5	3.4	3.5	3.7	3.5	3.7	3.6	3.4	3.5	3.6	3.4	3.5	250
255	3.8	3.8	4.1	3.4	3.3	3.5	3.6	3.5	3.6	3.5	3.4	3.5	3.5	3.4	3.5	255
260	3.7	3.8	4.1	3.4	3.3	3.4	3.5	3.4	3.6	3.4	3.3	3.4	3.4	3.3	3.4	260
265	3.7	3.7	4.1	3.3	3.2	3.4	3.5	3.4	3.5	3.3	3.2	3.4	3.3	3.2	3.4	265
270	3.6	3.7	4.1	3.2	3.2	3.4	3.4	3.3	3.5	3.3	3.2	3.4	3.3	3.2	3.4	270
275	3.5	3.6		3.2	3.1	3.4	3.3	3.3	3.5	3.2	3.1	3.4	3.2	3.1	3.3	275
280	3.5	3.6		3.1	3.1	3.4	3.2	3.2	3.5	3.1	3.1	3.3	3.2	3.1	3.3	280
285	3.4	3.6		3	3		3.2	3.2	3.5	3.1	3	3.3	3	3	3.3	285
290	3.1	3.5		3	3		3.1	3.1		3	3		2.8	3	3.3	290
295	2.7			2.9	3		2.9	3.1		2.7	3		2.5	3		295
300				2.7	2.9		2.5	3		2.4	2.9			2.8		300
305								2.6			2.6					305
310											2.2					310

t 259_107_25151 / 45151_00_000

Lifting heights

Hauteurs de levage

TVNZK

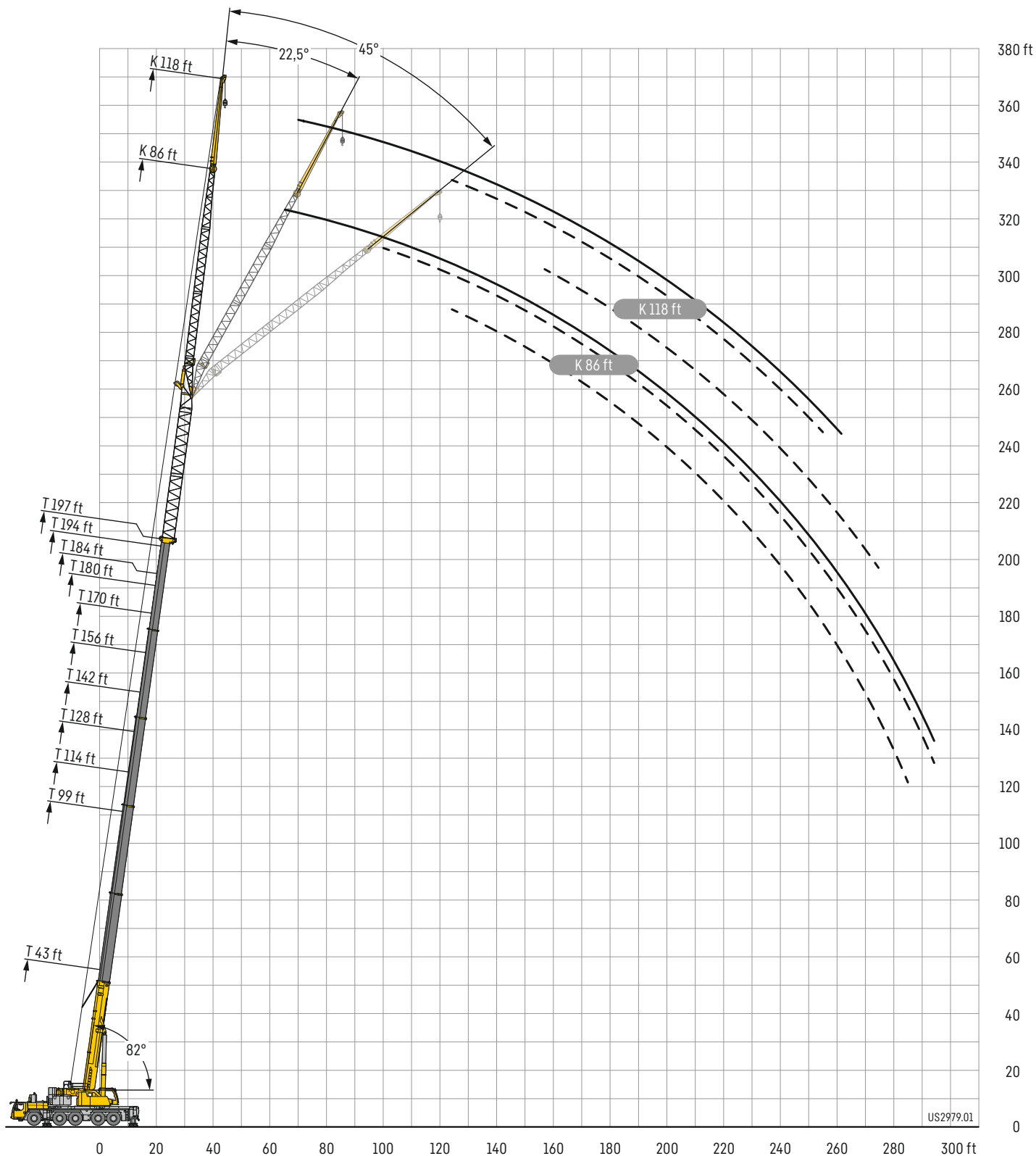

US2979.01

Lifting capacities

Forces de levage

TVNZK

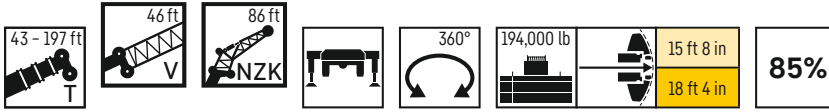

	43 ft + 46 ft			99 ft + 46 ft			114 ft + 46 ft			128 ft + 46 ft			142 ft + 46 ft			156 ft + 46 ft			
	86 ft																		
	0°	22,5°	45°	0°	22,5°	45°	0°	22,5°	45°	0°	22,5°	45°	0°	22,5°	45°	0°	22,5°	45°	
24	16.5																		24
26	16.4																		26
28	16.3																		28
30	16.2																		30
32	16.1																		32
34	16			16.5															34
36	15.9			16.4			15.7												36
38	15.8			16.3			15.6												38
40	15.7			16.2			15.5			14.6									40
45	15			16.1			15.4			14.4			13.3						45
50	14.3			15.9			15.2			14.3			13.2			11.9			50
55	13.5			15.6			15			14.1			13.1			11.8			55
60	12.7	12.2		15.2			14.8			14			13			11.7			60
65	12	11.6		14.6			14.3			13.8			12.8			11.6			65
70	11.3	11.1		14	12.3		13.8			13.3			12.6			11.5			70
75	10.6	10.5		13.4	11.9		13.3	11.8		12.9			12.3			11.3			75
80	10	10	8.3	12.8	11.5		12.8	11.4		12.4	11.2		11.9	10.6		11			80
85	9.5	9.4	8.1	12.3	11.1		12.3	11		12	10.8		11.5	10.3		10.7	9.7		85
90	8.9	8.9	7.9	11.7	10.7		11.8	10.6		11.6	10.4		11.1	10		10.4	9.4		90
95	8.4	8.4	7.7	11.2	10.2	8.2	11.3	10.2	8.2	11.1	10		10.7	9.7		10.1	9.2		95
100	7.9	7.9	7.6	10.7	9.8	8	10.9	9.8	8	10.7	9.7	7.9	10.4	9.4		9.8	8.9		100
105	7.5	7.5	7.4	10.2	9.4	7.9	10.4	9.4	7.9	10.3	9.3	7.8	10	9.1	7.7	9.5	8.6		105
110	7.1	7.2	7.1	9.8	9	7.8	10	9.1	7.7	9.9	9	7.7	9.7	8.8	7.6	9.2	8.4	7.4	110
115	6.8	6.8	6.8	9.4	8.7	7.6	9.6	8.7	7.6	9.5	8.7	7.6	9.3	8.5	7.5	8.9	8.1	7.3	115
120	6.4	6.5	6.6	9	8.3	7.5	9.2	8.4	7.5	9.2	8.4	7.5	9	8.2	7.4	8.6	7.9	7.2	120
125	6.1	6.2	6.3	8.6	8	7.4	8.8	8.1	7.4	8.8	8.1	7.4	8.7	7.9	7.3	8.3	7.7	7	125
130	5.8	5.9	6.1	8.2	7.7	7.2	8.5	7.8	7.3	8.5	7.8	7.2	8.4	7.7	7.1	8.1	7.4	6.9	130
135	5.6	5.7	5.9	7.8	7.4	7	8.1	7.5	7.1	8.2	7.5	7	8.1	7.5	6.9	7.8	7.2	6.8	135
140	5.3	5.4	5.6	7.5	7.1	6.8	7.8	7.3	6.9	7.9	7.3	6.9	7.8	7.2	6.8	7.6	7.1	6.6	140
145	5	5.2	5.4	7.3	6.9	6.7	7.5	7	6.7	7.6	7.1	6.7	7.6	7	6.6	7.4	6.9	6.5	145
150	4.9	5	5.2	7	6.7	6.5	7.2	6.8	6.5	7.4	6.9	6.5	7.3	6.9	6.5	7.2	6.7	6.3	150
155	4.6	4.8	5.1	6.7	6.4	6.3	7	6.6	6.4	7.1	6.7	6.4	7.1	6.7	6.4	7	6.6	6.2	155
160	4.5	4.6		6.5	6.2	6.2	6.7	6.4	6.2	6.9	6.5	6.3	6.9	6.5	6.2	6.8	6.4	6.1	160
165	4.3	4.5		6.2	6	6	6.5	6.2	6.1	6.7	6.3	6.1	6.7	6.3	6.1	6.6	6.2	6	165
170				6	5.8	5.8	6.3	6	6	6.4	6.1	6	6.5	6.1	6	6.4	6.1	5.9	170
175				5.8	5.6	5.7	6	5.8	5.8	6.2	6	5.9	6.3	6	5.9	6.2	5.9	5.8	175
180				5.6	5.5	5.5	5.8	5.7	5.7	6	5.8	5.7	6.1	5.8	5.7	6	5.8	5.6	180
185				5.4	5.3	5.4	5.7	5.5	5.6	5.8	5.6	5.6	5.9	5.7	5.6	5.9	5.6	5.5	185
190				5.2	5.1	5.3	5.5	5.4	5.4	5.6	5.5	5.5	5.7	5.5	5.5	5.7	5.5	5.4	190
195				5	5	5.2	5.3	5.2	5.3	5.5	5.3	5.4	5.6	5.4	5.4	5.5	5.3	5.3	195
200				4.9	4.8		5.1	5	5.2	5.3	5.2	5.3	5.4	5.2	5.3	5.4	5.2	5.2	200
205				4.7	4.7		4.9	4.9	5.1	5.1	5	5.2	5.2	5.1	5.2	5.3	5.1	5.1	205
210				4.6	4.6		4.8	4.8	5	5	4.9	5.1	5.1	5	5.1	5.1	5	5.1	210
215				4.4	4.5		4.6	4.7		4.8	4.8	5	4.9	4.9	5	5	4.9	5	215
220				4.3			4.5	4.6		4.7	4.7	4.9	4.8	4.7	4.9	4.8	4.8	4.9	220
225				4.2			4.4	4.5		4.6	4.6		4.7	4.6	4.9	4.7	4.6	4.8	225
230							4.3	4.4		4.4	4.5		4.6	4.5	4.8	4.6	4.5	4.8	230
235							4.2			4.3	4.4		4.4	4.5		4.5	4.5	4.7	235
240							2.6			4.2	4.3		4.3	4.4		4.4	4.4	4.7	240
245										4.1	4.3		4.2	4.3		4.3	4.3	4.7	245
250										4			4.1	4.2		4.2	4.2	4.7	250
255													4.1	4.2		4.1	4.2		255
260													4	4.2		4	4.1		260
265													3.4			4	4.1		265
270																3.9	4.1		270
275																3.4			275

t_259_107_24151 / 44151_00_000

Lifting capacities

Forces de levage

TVNZK

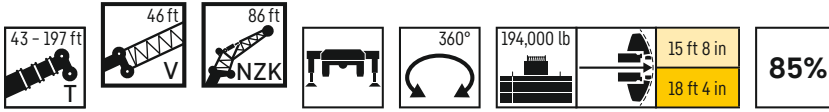

	170 ft + 46 ft			180 ft + 46 ft			184 ft + 46 ft			194 ft + 46 ft			197 ft + 46 ft			
	0°	22,5°	45°	0°	22,5°	45°	0°	22,5°	45°	0°	22,5°	45°	0°	22,5°	45°	
55	10.4															55
60	10.3			8.6			8.7									60
65	10.2			8.5			8.7			7.7			7.6			65
70	10.2			8.5			8.6			7.7			7.6			70
75	10.1			8.4			8.6			7.6			7.5			75
80	9.9			8.2			8.5			7.5			7.4			80
85	9.6			8.1			8.3			7.4			7.3			85
90	9.4	8.6		8			8.2			7.3			7.2			90
95	9.1	8.4		7.8	7.2		8	7.3		7.3			7.1			95
100	8.9	8.2		7.7	7.1		7.8	7.3		7.2	6.5		7	6.4		100
105	8.7	8		7.5	7.1		7.6	7.2		7.1	6.5		7	6.4		105
110	8.4	7.8		7.3	7		7.5	7.1		7	6.5		6.9	6.4		110
115	8.2	7.5	7	7.2	6.8		7.3	6.9		6.8	6.5		6.8	6.4		115
120	8	7.4	6.8	7.1	6.7	6.2	7.2	6.8	6.2	6.7	6.4		6.6	6.3		120
125	7.7	7.2	6.7	6.9	6.6	6.2	7	6.6	6.2	6.6	6.3	5.7	6.5	6.2	5.5	125
130	7.5	7	6.6	6.8	6.4	6.1	6.9	6.5	6.2	6.5	6.2	5.7	6.4	6.1	5.5	130
135	7.3	6.9	6.4	6.6	6.3	6	6.7	6.4	6.1	6.3	6.1	5.7	6.3	6	5.5	135
140	7.2	6.7	6.3	6.5	6.2	5.9	6.6	6.2	5.9	6.2	5.9	5.7	6.1	5.9	5.5	140
145	7	6.6	6.2	6.3	6	5.8	6.4	6.1	5.8	6.1	5.8	5.6	6	5.8	5.5	145
150	6.8	6.4	6.1	6.2	5.9	5.7	6.3	6	5.7	5.9	5.7	5.5	5.9	5.7	5.5	150
155	6.6	6.3	6	6.1	5.7	5.5	6.1	5.9	5.6	5.8	5.6	5.4	5.8	5.5	5.4	155
160	6.5	6.1	5.9	5.9	5.6	5.4	6	5.7	5.5	5.7	5.5	5.3	5.7	5.4	5.3	160
165	6.3	6	5.8	5.8	5.4	5.2	5.9	5.6	5.4	5.6	5.4	5.2	5.5	5.3	5.2	165
170	6.1	5.8	5.7	5.6	5.3	5.1	5.7	5.5	5.3	5.5	5.2	5.1	5.4	5.2	5.1	170
175	6	5.7	5.6	5.5	5.1	5	5.6	5.3	5.2	5.4	5.1	5	5.3	5.1	5	175
180	5.8	5.6	5.5	5.4	5	4.9	5.5	5.2	5.1	5.2	5	4.9	5.2	5	4.9	180
185	5.7	5.4	5.4	5.2	4.9	4.8	5.4	5.1	5	5.1	4.9	4.8	5.1	4.9	4.8	185
190	5.5	5.3	5.3	5.1	4.8	4.7	5.2	4.9	4.9	5	4.7	4.7	5	4.7	4.7	190
195	5.4	5.2	5.2	4.9	4.6	4.6	5.1	4.8	4.7	4.9	4.6	4.6	4.9	4.6	4.6	195
200	5.3	5.1	5.1	4.8	4.5	4.5	5	4.7	4.6	4.8	4.5	4.5	4.8	4.5	4.5	200
205	5.1	5	5	4.7	4.4	4.4	4.9	4.6	4.6	4.7	4.4	4.4	4.7	4.4	4.4	205
210	5	4.9	5	4.6	4.3	4.3	4.8	4.5	4.5	4.6	4.3	4.3	4.6	4.3	4.3	210
215	4.9	4.8	4.9	4.4	4.2	4.2	4.6	4.4	4.4	4.5	4.2	4.2	4.5	4.2	4.2	215
220	4.8	4.7	4.8	4.3	4.1	4.1	4.5	4.3	4.3	4.3	4.1	4.1	4.4	4.1	4.1	220
225	4.6	4.6	4.7	4.2	4	4.1	4.4	4.2	4.2	4.2	4	4.1	4.3	4	4.1	225
230	4.5	4.5	4.7	4.1	3.9	4	4.3	4.1	4.2	4.1	3.9	4	4.2	3.9	4	230
235	4.4	4.4	4.6	4	3.8	3.9	4.2	4	4.1	4	3.9	3.9	4.1	3.9	3.9	235
240	4.3	4.3	4.6	3.9	3.7	3.8	4.1	3.9	4	4	3.8	3.9	4	3.8	3.9	240
245	4.2	4.2	4.5	3.8	3.7	3.8	4	3.8	4	3.9	3.7	3.8	3.9	3.7	3.8	245
250	4.2	4.2	4.5	3.7	3.6	3.7	3.9	3.8	3.9	3.8	3.6	3.8	3.8	3.6	3.8	250
255	4.1	4.1	4.5	3.6	3.5	3.7	3.8	3.7	3.9	3.7	3.5	3.7	3.7	3.6	3.7	255
260	4	4.1	4.5	3.5	3.5	3.7	3.7	3.6	3.9	3.6	3.5	3.7	3.6	3.5	3.7	260
265	4	4	4.5	3.5	3.4	3.7	3.6	3.6	3.8	3.5	3.4	3.6	3.5	3.4	3.6	265
270	3.9	4		3.4	3.3	3.7	3.6	3.5	3.8	3.5	3.4	3.6	3.5	3.4	3.6	270
275	3.8	4		3.3	3.3	3.7	3.5	3.5	3.8	3.4	3.3	3.6	3.4	3.3	3.6	275
280	3.4	3.9		3.3	3.3		3.4	3.4		3.3	3.3	3.6	3.2	3.3	3.6	280
285	3.2			3.2	3.3		3.3	3.4		3.1	3.3		2.9	3.3	3.5	285
290				3	3.2		2.9	3.3		2.7	3.2		2.6	3.1		290
295				2.3				3		2.4	2.9		2.2	2.8		295
300											2.5					300

t_259_107_24151 / 44151_00_000

Lifting capacities

Forces de levage

TVNZK

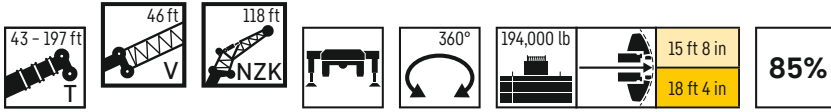

	43 ft + 46 ft			99 ft + 46 ft			114 ft + 46 ft			128 ft + 46 ft			142 ft + 46 ft			156 ft + 46 ft			
	0°	22,5°	45°	0°	22,5°	45°	0°	22,5°	45°	0°	22,5°	45°	0°	22,5°	45°	0°	22,5°	45°	
28	8.8																		28
30	8.8																		30
32	8.7																		32
34	8.7																		34
36	8.6																		36
38	8.6																		38
40	8.5			8.8															40
45	8.4			8.7			8			7.8									45
50	8.3			8.6			8			7.8			7.2						50
55	8.1			8.5			8			7.7			7.2			6.6			55
60	8			8.4			8			7.7			7.2			6.6			60
65	7.8			8.3			8			7.6			7.2			6.6			65
70	7.6			8.2			7.9			7.5			7.1			6.6			70
75	7.3	6.4		8.1			7.8			7.4			7			6.5			75
80	7	6.2		7.9			7.7			7.4			7			6.5			80
85	6.8	6		7.8			7.6			7.3			6.9			6.4			85
90	6.5	5.8		7.6	6.3		7.5	6.2		7.2			6.9			6.4			90
95	6.3	5.6		7.4	6.1		7.3	6.1		7.2	6		6.8			6.3			95
100	6.1	5.4		7.2	6		7.1	5.9		7	5.8		6.7	5.7		6.3			100
105	5.8	5.2		7	5.8		7	5.8		6.8	5.7		6.6	5.6		6.2	5.4		105
110	5.6	5	4.3	6.8	5.6		6.8	5.6		6.7	5.6		6.5	5.4		6.1	5.3		110
115	5.3	4.9	4.1	6.6	5.5		6.6	5.5		6.5	5.4		6.3	5.3		6.1	5.2		115
120	5.1	4.7	4.1	6.4	5.3	4.3	6.4	5.3		6.4	5.3		6.2	5.2		5.9	5.1		120
125	4.8	4.6	4	6.2	5.2	4.2	6.2	5.2	4.2	6.2	5.2		6	5.1		5.8	5		125
130	4.6	4.5	3.9	6	5.1	4.1	6.1	5.1	4.1	6	5.1	4.1	5.9	5	4	5.6	4.9		130
135	4.4	4.3	3.9	5.8	4.9	4.1	5.9	5	4	5.9	4.9	4	5.7	4.9	4	5.5	4.8		135
140	4.1	4.2	3.8	5.6	4.8	4	5.7	4.8	4	5.7	4.8	4	5.6	4.8	3.9	5.3	4.7	3.8	140
145	3.9	4.1	3.7	5.4	4.7	4	5.5	4.7	3.9	5.5	4.7	3.9	5.4	4.7	3.9	5.2	4.6	3.8	145
150	3.7	3.9	3.7	5.2	4.6	3.9	5.3	4.6	3.9	5.3	4.6	3.9	5.3	4.6	3.8	5.1	4.5	3.8	150
155	3.6	3.7	3.7	5	4.5	3.9	5.1	4.5	3.8	5.1	4.5	3.8	5.1	4.5	3.8	4.9	4.4	3.7	155
160	3.4	3.6	3.6	4.8	4.4	3.8	5	4.4	3.8	5	4.4	3.8	4.9	4.4	3.7	4.8	4.3	3.7	160
165	3.2	3.4	3.6	4.7	4.3	3.8	4.8	4.4	3.8	4.8	4.4	3.7	4.8	4.3	3.7	4.6	4.3	3.6	165
170	3.1	3.2	3.4	4.5	4.2	3.7	4.6	4.3	3.7	4.7	4.3	3.7	4.6	4.2	3.7	4.5	4.2	3.6	170
175	2.9	3.1	3.3	4.3	4.1	3.7	4.4	4.2	3.7	4.5	4.2	3.7	4.5	4.2	3.6	4.4	4.1	3.6	175
180	2.8	2.9	3.2	4.1	4	3.7	4.3	4.1	3.7	4.3	4.1	3.6	4.4	4.1	3.6	4.2	4	3.6	180
185	2.6	2.8	3.1	4	3.9	3.7	4.1	4	3.7	4.2	4	3.6	4.2	4	3.6	4.1	3.9	3.5	185
190	2.5	2.7		3.8	3.8	3.6	4	3.9	3.6	4	3.9	3.6	4.1	3.9	3.6	4	3.8	3.5	190
195	2.4	2.6		3.7	3.6	3.6	3.8	3.7	3.6	3.9	3.8	3.6	3.9	3.8	3.5	3.9	3.7	3.5	195
200	2.4			3.5	3.5	3.6	3.7	3.6	3.6	3.8	3.7	3.6	3.8	3.7	3.5	3.8	3.6	3.5	200
205				3.4	3.4	3.5	3.6	3.5	3.5	3.6	3.6	3.5	3.7	3.6	3.5	3.6	3.5	3.5	205
210				3.3	3.3	3.4	3.4	3.4	3.4	3.5	3.5	3.5	3.6	3.5	3.4	3.5	3.4	3.4	210
215				3.1	3.1	3.3	3.3	3.3	3.4	3.4	3.4	3.4	3.4	3.4	3.4	3.4	3.3	3.3	215
220				3	3	3.2	3.2	3.2	3.3	3.3	3.3	3.3	3.3	3.2	3.3	3.3	3.2	3.3	220
225				2.9	2.9	3.2	3	3.1	3.2	3.2	3.2	3.2	3.2	3.2	3.2	3.2	3.1	3.2	225
230				2.8	2.8		2.9	3	3.1	3	3.1	3.2	3.1	3.1	3.2	3.1	3.1	3.1	230
235				2.7	2.8		2.8	2.9	3.1	2.9	3	3.1	3	3	3.1	3	3	3.1	235
240				2.6	2.7		2.7	2.8		2.9	2.9	3.1	2.9	2.9	3.1	2.9	2.9	3	240
245				2.5	2.6		2.6	2.7		2.8	2.8	3	2.8	2.8	3	2.8	2.8	3	245
250				2.4			2.6	2.6		2.7	2.7	3	2.8	2.8	2.9	2.8	2.7	2.9	250
255				2.4			2.5	2.6		2.6	2.6		2.7	2.7	2.9	2.7	2.7	2.9	255
260							2.4	2.5		2.5	2.6		2.6	2.6	2.9	2.6	2.6	2.8	260
265							2.3			2.4	2.5		2.5	2.5		2.5	2.6	2.8	265
270							2.3			2.4	2.5		2.4	2.5		2.4	2.5	2.8	270
275										2.3			2.4	2.5		2.4	2.4	2.8	275
280										2.3			2.3	2.4		2.3	2.4		280
285													2.2	2.4		2.3	2.4		285
290													2.2				2.3		290
295																	2.3		295

t 259_107_26151 / 46151_00_000

Lifting capacities

Forces de levage

TVNZK

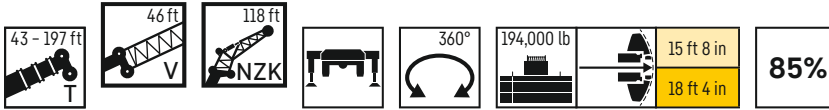

	170 ft + 46 ft			180 ft + 46 ft			184 ft + 46 ft			194 ft + 46 ft			197 ft + 46 ft			
	0°	22,5°	45°	0°	22,5°	45°	0°	22,5°	45°	0°	22,5°	45°	0°	22,5°	45°	
60	6.1															60
65	6			5.2			5.2									65
70	5.9			5.1			5.1			4.7			3.6			70
75	5.9			5.1			5.2			4.7			3.6			75
80	5.9			5.1			5.1			4.7			3.6			80
85	5.8			5			5.1			4.6			3.6			85
90	5.8			5			5.1			4.6			3.6			90
95	5.7			5			5			4.6			3.6			95
100	5.7			4.9			5			4.5			3.6			100
105	5.7			4.9			5			4.5			3.6			105
110	5.6	5		4.8			5			4.4			3.6			110
115	5.5	4.9		4.8			4.9			4.4			3.6			115
120	5.5	4.8		4.7	4.3		4.8	4.5		4.3			3.6			120
125	5.4	4.7		4.7	4.3		4.8	4.4		4.3	3.9		3.6	3.9		125
130	5.3	4.6		4.6	4.3		4.7	4.4		4.3	3.9		3.6	3.8		130
135	5.1	4.6		4.5	4.3		4.6	4.3		4.2	3.9		3.6	3.8		135
140	5	4.5		4.4	4.2		4.5	4.2		4.2	3.9		3.6	3.8		140
145	4.9	4.4	3.7	4.3	4.1		4.4	4.2		4.1	3.9		3.6	3.8		145
150	4.7	4.3	3.7	4.2	4.1	3.5	4.3	4.1	3.5	4	3.9		3.6	3.8		150
155	4.6	4.3	3.6	4.1	4	3.5	4.2	4	3.5	3.9	3.8	3.2	3.6	3.8	3.1	155
160	4.5	4.2	3.6	4	3.9	3.5	4.1	4	3.5	3.9	3.8	3.2	3.6	3.7	3.1	160
165	4.4	4.1	3.6	3.9	3.8	3.4	4	3.9	3.4	3.8	3.7	3.2	3.6	3.6	3.1	165
170	4.3	4	3.5	3.8	3.8	3.4	3.9	3.8	3.4	3.7	3.6	3.2	3.6	3.6	3.1	170
175	4.2	3.9	3.5	3.7	3.7	3.4	3.8	3.7	3.4	3.6	3.5	3.2	3.6	3.5	3.1	175
180	4	3.9	3.5	3.7	3.6	3.4	3.7	3.6	3.4	3.5	3.4	3.2	3.5	3.4	3.1	180
185	3.9	3.8	3.5	3.6	3.5	3.4	3.6	3.5	3.3	3.4	3.4	3.2	3.4	3.3	3.1	185
190	3.8	3.7	3.4	3.5	3.4	3.3	3.6	3.4	3.3	3.4	3.3	3.2	3.3	3.3	3.1	190
195	3.7	3.6	3.4	3.4	3.3	3.3	3.5	3.4	3.3	3.3	3.2	3.2	3.2	3.2	3.1	195
200	3.6	3.5	3.4	3.3	3.2	3.2	3.4	3.3	3.2	3.2	3.1	3.1	3.2	3.1	3.1	200
205	3.5	3.4	3.4	3.2	3.1	3.1	3.3	3.2	3.2	3.1	3.1	3.1	3.1	3	3	205
210	3.4	3.3	3.3	3.1	3.1	3	3.2	3.1	3.1	3	3	3	3	2.9	3	210
215	3.3	3.2	3.2	3	3	2.9	3.1	3.1	3.1	3	2.9	2.9	2.9	2.9	2.9	215
220	3.2	3.1	3.2	3	2.9	2.9	3	3	3	2.9	2.8	2.8	2.9	2.8	2.9	220
225	3.1	3.1	3.1	2.9	2.8	2.8	3	2.9	2.9	2.8	2.7	2.8	2.8	2.7	2.8	225
230	3	3	3.1	2.8	2.7	2.7	2.9	2.8	2.8	2.7	2.6	2.7	2.7	2.6	2.7	230
235	2.9	2.9	3	2.7	2.6	2.6	2.8	2.7	2.8	2.6	2.6	2.6	2.6	2.6	2.6	235
240	2.9	2.8	2.9	2.6	2.5	2.6	2.7	2.7	2.7	2.6	2.5	2.6	2.6	2.5	2.6	240
245	2.8	2.8	2.9	2.5	2.4	2.5	2.6	2.6	2.6	2.5	2.4	2.5	2.5	2.4	2.5	245
250	2.7	2.7	2.9	2.4	2.4	2.4	2.6	2.5	2.6	2.4	2.3	2.5	2.4	2.3	2.5	250
255	2.6	2.6	2.8	2.3	2.3	2.4	2.5	2.4	2.5	2.3	2.3	2.4	2.3	2.3	2.4	255
260	2.6	2.6	2.8	2.3	2.2	2.3	2.4	2.3	2.5	2.3		2.4	2.3		2.4	260
265	2.5	2.5	2.7			2.3	2.3	2.3	2.4			2.3			2.3	265
270	2.4	2.4	2.7			2.3	2.3	2.2	2.4			2.3			2.3	270
275	2.4	2.4	2.7						2.3			2.2			2.2	275
280	2.3	2.4	2.7						2.3							280
285	2.2	2.3	2.7						2.3							285
290		2.3	2.7						2.2							290
295		2.2							2.2							295
300		2.2							2.2							300
305		2.2														305

t_259_107_26151 / 46151_00_000

Lifting heights

Hauteurs de levage

TS

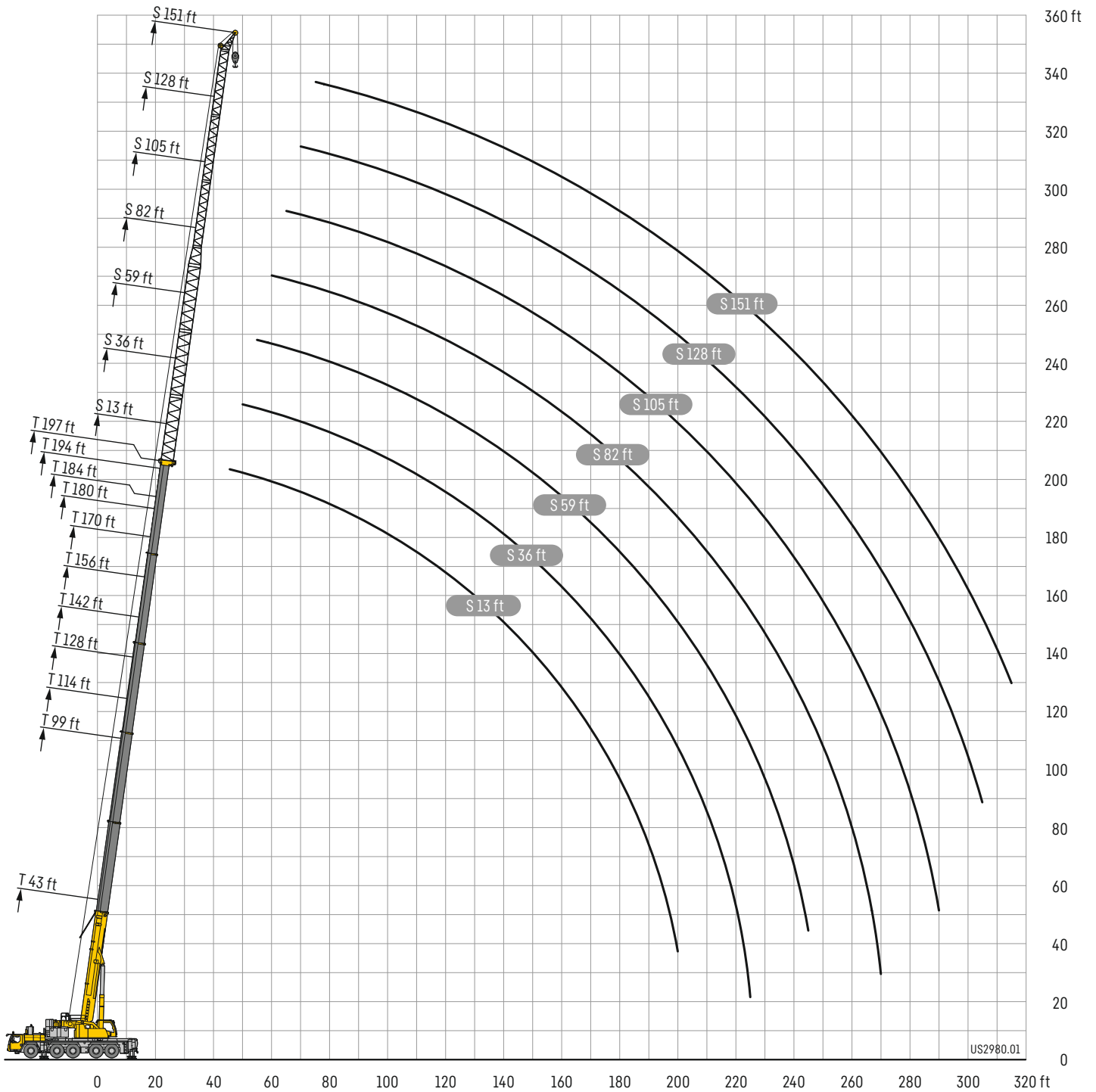

Lifting capacities

Forces de levage

TS 13 ft

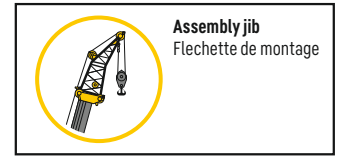
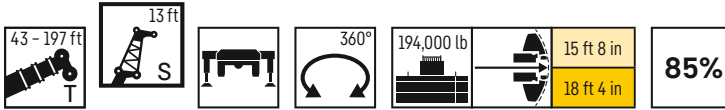

	43 ft	57 ft	71 ft	73 ft	85 ft	99 ft	114 ft	128 ft	142 ft	156 ft	170 ft	180 ft	184 ft	194 ft	197 ft	
	13 ft															
10	90.8	90.8														10
11	90.8	90.8														11
12	90.8	90.8														12
13	90.8	90.8	90.8	90.8												13
14	90.8	90.8	90.8	90.8												14
15	90.8	90.8	90.8	90.8	90.8											15
16	90.8	90.8	90.8	90.8	90.8											16
17	90.8	90.8	90.8	90.8	90.8											17
18	90.8	90.8	90.8	90.8	90.8											18
19	90.8	90.8	90.8	90.8	90.8	90.8										19
20	90.8	90.8	90.8	90.8	90.8	90.8										20
22	90.8	90.8	90.8	90.8	90.8	90.8	90.8									22
24	90.4	90.8	90.8	90.8	90.8	90.8	90.8									24
26	89.1	90.8	90.8	90.8	90.8	90.8	90.8	90.8								26
28	87.5	90.8	90.8	90.8	90.8	90.8	90.8	90.8								28
30	85	90.6	90.8	90.8	90.8	90.8	90.8	90.8	90.8							30
32	82.2	89.5	90.8	90.8	90.8	90.8	90.8	90.8	90.8	72.8						32
34	78.9	88.5	90.8	90.8	90.8	90.8	90.8	90.8	90.8	81.4						34
36	75.6	87	90.7	90.7	90.8	90.8	90.8	90.8	90.8	80.4	61.5					36
38	72.7	84.9	89.8	90.3	90.8	90.8	90.8	90.8	90.8	79.3	65.1					38
40	70	82.8	89	89.5	90.8	90.8	90.8	90.8	90.5	78.1	64.3	51.6	53.7			40
45	64.3	76.2	85.8	86.9	89.7	90.8	90.8	90.7	85.6	74.4	62.1	50.2	52.3	44.8	44	45
50	60.3	70.6	81.2	82.7	87.6	90.2	90.5	86.3	79.4	70.5	59.5	48.3	50.5	43.9	43.1	50
55		66	75.7	77.4	84.2	88.6	89.6	79.2	73.5	66.6	56.9	46.2	48.5	42.7	42	55
60		62.2	71.1	72.7	79.9	85.6	85.5	73.2	68	62.9	54.3	44	46.6	41.3	40.7	60
65			67.2	68.6	75.3	78.8	77.4	68.5	63.1	59.5	51.9	41.8	44.7	39.9	39.4	65
70			63.8	65.1	71.4	71.6	70.1	64.4	58.8	55.9	49.5	39.8	42.9	38.4	38	70
75			61.1	61.8	66.3	65.3	63.9	60.5	55.1	52.5	47.1	37.9	41.1	36.7	36.5	75
80				49.9	60.8	59.9	58.4	57.2	52.3	49.3	44.9	36	39.5	35.2	35	80
85					56.1	55.2	53.7	53.1	49.4	46.4	42.8	34.3	37.9	33.8	33.7	85
90					48.8	51	49.6	49	46.5	43.7	40.8	32.7	36.5	32.4	32.3	90
95						47.4	45.9	45.6	44.1	41.2	38.8	31.3	35.1	31.1	31	95
100						44.2	42.6	43.5	42.1	39	37.3	30	33.8	29.9	29.8	100
105						36.2	40.2	40.6	39.8	36.9	35.6	28.6	32.6	28.8	28.7	105
110							38	37.8	37.2	34.9	33.8	27.4	31.4	27.7	27.7	110
115							36.7	35.4	34.7	33.2	32.1	26.3	30.1	26.6	26.6	115
120							28.2	33.1	32.4	31.9	30.6	25.2	28.9	25.6	25.6	120
125								31.1	30.4	30.5	29.1	24.2	27.6	24.7	24.6	125
130								29	28.7	28.8	27.7	23.3	26.4	23.8	23.7	130
135								21.1	27.7	27.1	26	22.4	25.2	23	22.7	135
140									26.2	25.5	24.8	21.5	24.1	22.2	21.9	140
145									23.5	24	23.5	20.7	22.9	21.4	21	145
150										22.7	22.6	19.9	21.5	20.7	20.2	150
155										21.9	21.4	19.1	20.2	20	19.4	155
160										18.8	20.2	18.5	19	19.2	18.7	160
165											19.1	17.8	17.9	18.2	17.9	165
170											17.9	17.2	16.9	17.1	16.9	170
175											13.8	16.7	15.9	16.1	15.9	175
180												16	15	15.2	15	180
185												11.9	13.5	14.3	14.1	185
190													9.2	13.5	13.2	190
195														11.9	11.5	195
200														7.8	9.5	200

t_259_105_10151 / 30151_00_000

Lifting capacities

Forces de levage

TS 36 ft

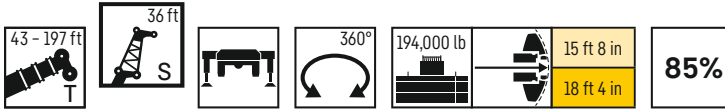

	43 ft	99 ft	114 ft	128 ft	142 ft	156 ft	170 ft	180 ft	184 ft	194 ft	197 ft	
	36 ft											
12	77.5											12
13	75.8											13
14	72.9											14
15	70.2											15
16	67.5											16
17	65.1											17
18	62.7											18
19	60.4											19
20	58.2											20
22	54.3	77.1										22
24	50.7	73.7										24
26	47.7	70.5	68.5									26
28	44.8	67.5	67.7	65.9								28
30	42.2	64.6	65.7	63.9								30
32	39.9	61.8	63.5	61.9	58.2							32
34	37.8	59.3	61.3	60.1	57.2							34
36	36	56.9	59.2	58.3	55.8	51.8						36
38	34.1	54.6	57.2	56.6	54.4	50.7						38
40	32.5	52.5	55.2	55	53.1	49.7	44.8					40
45	29.1	47.9	50.6	51.1	49.9	47.2	43.3	37.7	38.2			45
50	26.3	43.7	46.6	47.4	46.9	44.8	41.6	36.5	37.1	34.1	33.5	50
55	23.9	40.3	43	44.2	44	42.4	39.9	35.4	36	33.4	32.8	55
60	21.9	37.3	40.1	41.4	41.4	40.3	38.2	34.2	34.9	32.5	32.1	60
65	20.2	34.7	37.3	38.8	39.2	38.3	36.7	33.2	33.7	31.7	31.3	65
70	18.8	32.4	35.1	36.5	37	36.5	35.2	32.1	32.7	30.8	30.5	70
75		30.4	33	34.5	35.1	34.8	33.9	31.1	31.6	30	29.7	75
80		28.5	31.1	32.6	33.4	33.2	32.6	30	30.6	29.2	28.9	80
85		26.9	29.3	30.9	31.8	31.8	31.3	29	29.7	28.4	28.1	85
90		25.4	27.8	29.4	30.3	30.4	30.2	27.9	28.8	27.5	27.3	90
95		24.1	26.4	28	28.9	29.2	29.1	26.9	27.9	26.6	26.5	95
100		23	25.2	26.7	27.7	28.1	28.1	25.9	27.1	25.7	25.6	100
105		21.9	24	25.6	26.6	27	27.2	24.9	26.3	24.8	24.8	105
110		20.9	23	24.5	25.5	26	26.3	24	25.5	24	23.9	110
115		20	22	23.5	24.6	25.1	25.4	23.1	24.8	23.1	23.1	115
120		19.2	21.1	22.5	23.7	24.2	24.7	22.2	24.2	22.4	22.3	120
125		18.5	20.3	21.7	22.8	23.4	23.9	21.4	23.5	21.6	21.6	125
130		18.1	19.6	20.9	22	22.7	23.2	20.6	22.9	20.8	20.8	130
135			18.9	20.3	21.3	22	22.6	19.8	22.2	20.1	20.1	135
140			18.4	19.6	20.7	21.4	22	19.1	21.6	19.4	19.4	140
145				19	20	20.8	21.4	18.4	20.9	18.8	18.8	145
150				18.5	19.5	20.2	20.9	17.8	20.3	18.2	18.2	150
155				17.7	19	19.7	20.3	17.2	19.7	17.6	17.6	155
160					18.5	19.1	19.2	16.6	19.1	17	17.1	160
165					18.1	18.7	18.2	16	18.4	16.5	16.5	165
170					16.1	18	17.6	15.5	17.5	16	16	170
175						17	17.1	15	16.5	15.6	15.5	175
180						15.6	16.6	14.5	15.5	15.1	14.9	180
185						12.2	15.8	14.1	14.7	14.6	14.4	185
190							15	13.6	13.8	13.8	13.7	190
195							12.9	13.2	13.1	13.1	12.9	195
200							7.9	12.8	12.3	12.3	12.1	200
205								11.2	11.5	11.6	11.4	205
210								6.6	9	11	10.8	210
215									4	10.2	10.2	215
220										7.7	8.5	220
225										2.8	5.6	225

t_259_105_11151 / 31151_00_000

Lifting capacities

Forces de levage

TS 59 ft

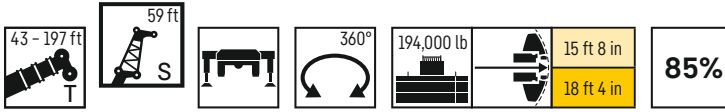

	43 ft	99 ft	114 ft	128 ft	142 ft	156 ft	170 ft	180 ft	184 ft	194 ft	197 ft	
	59 ft											
16	56.2											16
17	55.8											17
18	54.7											18
19	53.6											19
20	52.5											20
22	50.4											22
24	48.3											24
26	46.3											26
28	44.4	54.9										28
30	42.7	53.5	52.8									30
32	41	52.1	51.6									32
34	39.4	50.8	50.5	48.4								34
36	37.9	49.4	49.3	47.6								36
38	36.4	48.2	48.2	46.7	43.9							38
40	35.1	46.9	47.1	45.8	43.2							40
45	32.1	43.8	44.3	43.4	41.4	38.2						45
50	29.6	41.1	41.8	41.2	39.7	36.9	33.2	28.4	29			50
55	27.4	38.6	39.5	39.2	38	35.7	32.4	27.8	28.6	25.8	25.3	55
60	25.5	36.3	37.4	37.4	36.5	34.5	31.6	27.1	28.1	25.3	24.9	60
65	23.8	34.2	35.3	35.6	35	33.3	30.8	26.4	27.5	24.8	24.5	65
70	22.4	32.3	33.5	33.9	33.7	32.3	30	25.6	27	24.3	24	70
75	21.1	30.7	31.8	32.3	32.3	31.2	29.1	24.9	26.4	23.8	23.5	75
80	19.9	29.1	30.4	30.9	31	30.1	28.3	24.2	25.8	23.2	22.9	80
85	18.8	27.7	29	29.6	29.8	29.1	27.5	23.6	25	22.7	22.4	85
90	17.8	26.5	27.7	28.4	28.7	28.1	26.8	22.9	24.1	22.1	21.9	90
95	17	25.3	26.6	27.3	27.6	27.2	26.1	22.2	23.4	21.6	21.4	95
100		24.2	25.5	26.2	26.7	26.3	25.4	21.4	22.6	21	20.9	100
105		23.2	24.5	25.3	25.8	25.6	24.7	20.7	21.9	20.4	20.3	105
110		22.4	23.6	24.4	24.9	24.8	24.1	20	21.2	19.9	19.8	110
115		21.5	22.7	23.5	24.2	24.1	23.4	19.4	20.6	19.3	19.2	115
120		20.8	21.9	22.7	23.4	23.4	22.9	18.8	19.9	18.8	18.7	120
125		20.1	21.2	22	22.7	22.8	22.4	18.2	19.4	18.2	18.2	125
130		19.4	20.5	21.3	22.1	22.2	21.8	17.7	18.8	17.7	17.7	130
135		18.7	19.9	20.7	21.5	21.6	21.2	17.1	18.3	17.2	17.2	135
140		18	19.3	20.1	20.9	21.1	20.6	16.6	17.8	16.7	16.7	140
145		17.4	18.7	19.6	20.4	20.6	20	16.1	17.3	16.2	16.2	145
150		17	18.2	19.1	19.9	20.1	19.4	15.5	16.9	15.7	15.7	150
155			17.6	18.6	19.4	19.7	18.8	15	16.4	15.2	15.2	155
160			17.2	18.1	19	19.1	18.3	14.5	16	14.8	14.8	160
165			16.1	17.6	18.5	18.2	17.7	14	15.6	14.3	14.3	165
170				17.2	18.1	17.2	17.1	13.5	15.2	13.9	13.9	170
175				15.9	17.3	16.3	16.3	13.1	14.9	13.4	13.5	175
180				12.1	16.4	15.8	15.4	12.7	14.5	13	13	180
185					15.5	15.3	14.5	12.2	14.1	12.6	12.7	185
190					13.1	14.8	13.6	11.9	13.7	12.2	12.3	190
195					9.9	14	13	11.5	13.2	11.9	11.9	195
200						13.1	12.7	11.1	12.4	11.5	11.6	200
205						11.7	12.4	10.8	11.7	11.2	11.2	205
210							12.1	10.5	11.1	10.9	10.8	210
215							11.1	10.2	10.4	10.4	10.2	215
220							8.2	10	9.8	9.8	9.6	220
225								9.5	9.3	9.2	9	225
230								7	7.8	8.7	8.5	230
235									5.3	8.1	8	235
240										6.7	7.2	240
245										4.4	5.3	245

t_259_105_13151 / 33151_00_000

Lifting capacities

Forces de levage

TS 82 ft

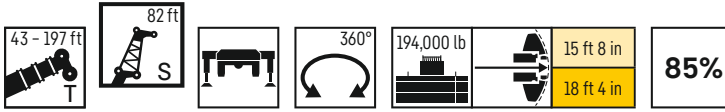

	43 ft	99 ft	114 ft	128 ft	142 ft	156 ft	170 ft	180 ft	184 ft	194 ft	197 ft	
	82 ft											
20	40											20
22	39.2											22
24	37.9											24
26	36.6											26
28	35.3											28
30	34.1											30
32	32.9	39.3										32
34	31.7	38.4	37.8									34
36	30.6	37.6	37.1									36
38	29.6	36.7	36.3	34.8								38
40	28.6	35.8	35.5	34.3								40
45	26.5	33.6	33.6	32.6	30.9							45
50	24.5	31.6	31.8	31.1	29.7	27.5	24.6					50
55	22.8	29.8	30.1	29.6	28.5	26.6	24.1	20.5	20.8			55
60	21.3	28.2	28.6	28.2	27.3	25.7	23.5	20.1	20.5	18.7	18.4	60
65	19.9	26.7	27.1	27	26.2	24.8	22.8	19.8	20.1	18.5	18.2	65
70	18.8	25.3	25.9	25.8	25.2	24	22.2	19.4	19.7	18.2	17.9	70
75	17.7	24.1	24.7	24.7	24.2	23.2	21.6	19	19.3	17.9	17.7	75
80	16.7	22.9	23.5	23.7	23.3	22.4	21	18.6	18.9	17.6	17.4	80
85	15.9	21.9	22.5	22.7	22.4	21.7	20.4	18.2	18.5	17.3	17.1	85
90	15.1	20.9	21.6	21.8	21.6	21	19.8	17.8	18.1	17	16.8	90
95	14.3	19.9	20.7	21	20.9	20.3	19.3	17.4	17.8	16.6	16.5	95
100	13.6	19.1	19.8	20.2	20.1	19.7	18.8	16.9	17.4	16.3	16.1	100
105	12.9	18.4	19.1	19.5	19.4	19.1	18.3	16.5	17	15.9	15.8	105
110	12.4	17.6	18.4	18.8	18.8	18.5	17.8	16	16.6	15.5	15.4	110
115	11.9	17	17.7	18.1	18.2	18	17.3	15.6	16.1	15.2	15.1	115
120		16.3	17.1	17.5	17.7	17.5	16.9	15.1	15.7	14.8	14.7	120
125		15.8	16.5	16.9	17.1	17	16.4	14.7	15.3	14.5	14.4	125
130		15.3	16	16.4	16.6	16.5	16.1	14.3	14.9	14.2	14.1	130
135		14.7	15.5	15.9	16.1	16.1	15.7	13.9	14.5	13.8	13.8	135
140		14.2	15	15.4	15.7	15.7	15.3	13.5	14.1	13.5	13.4	140
145		13.7	14.5	15	15.3	15.3	15	13.2	13.7	13.2	13.1	145
150		13.3	14	14.5	14.9	14.9	14.6	12.8	13.4	12.8	12.8	150
155		12.9	13.6	14.1	14.5	14.5	14.3	12.4	13	12.5	12.5	155
160		12.5	13.2	13.7	14.1	14.2	14	12.1	12.7	12.2	12.2	160
165		12.1	12.8	13.3	13.7	13.8	13.7	11.8	12.4	11.8	11.8	165
170		11.9	12.5	13	13.3	13.5	13.4	11.5	12.2	11.5	11.6	170
175		11.7	12.2	12.7	13	13.2	13.1	11.2	11.9	11.3	11.3	175
180			11.9	12.4	12.7	12.9	12.9	10.9	11.6	11	11	180
185			11.7	12.1	12.4	12.6	12.6	10.6	11.4	10.7	10.8	185
190			8.8	11.8	12.2	12.4	12.4	10.3	11.1	10.5	10.5	190
195				11.6	11.9	12.1	12.1	10.1	10.9	10.2	10.2	195
200				10.8	11.7	11.9	11.9	9.8	10.6	10	10	200
205					11.5	11.6	11.6	9.5	10.4	9.7	9.7	205
210					11.2	11.4	11	9.2	10.2	9.4	9.5	210
215					9.2	11.3	10.3	8.9	10	9.2	9.2	215
220						10.9	9.7	8.6	9.8	8.9	8.9	220
225						9.3	9.4	8.4	9.5	8.6	8.7	225
230						7.4	9.3	8.1	9	8.4	8.4	230
235							9.1	7.9	8.5	8.2	8.1	235
240							7.6	7.6	8	7.9	7.8	240
245							4.9	7.5	7.5	7.4	7.3	245
250								6.6	6.8	7.1	6.9	250
255								3.9	5.1	6.7	6.6	255
260										5.9	6	260
265										4.2	4.8	265
270											2.7	270

t_259_105_15151 / 35151_00_000

Lifting capacities

Forces de levage

TS 105 ft

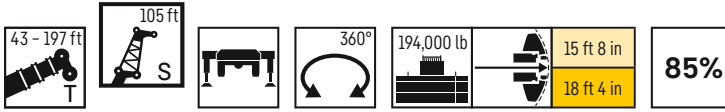

	43 ft	99 ft	114 ft	128 ft	142 ft	156 ft	170 ft	180 ft	184 ft	194 ft	197 ft	
	105 ft											
24	28.7											24
26	28.4											26
28	27.8											28
30	26.9											30
32	26.1											32
34	25.4											34
36	24.6	28.4										36
38	23.9	28	27.3									38
40	23.2	27.5	26.9									40
45	21.5	26	25.7	24.7	22.9							45
50	20	24.6	24.5	23.7	22.3	20.5						50
55	18.7	23.3	23.3	22.7	21.6	20	17.9					55
60	17.5	22.1	22.2	21.7	20.8	19.4	17.5	15.1	15.4			60
65	16.4	21	21.1	20.8	20.1	18.8	17.1	14.9	15.1	13.9	13.6	65
70	15.4	19.9	20.1	19.9	19.3	18.2	16.7	14.6	14.8	13.7	13.4	70
75	14.5	19	19.2	19.1	18.6	17.7	16.3	14.3	14.6	13.4	13.2	75
80	13.6	18	18.4	18.3	18	17.1	15.9	14	14.3	13.2	13	80
85	12.9	17.2	17.6	17.5	17.3	16.6	15.4	13.7	14	13	12.8	85
90	12.2	16.4	16.8	16.8	16.7	16.1	15	13.4	13.7	12.7	12.6	90
95	11.5	15.7	16.1	16.2	16.2	15.6	14.6	13.1	13.4	12.5	12.4	95
100	10.9	15	15.4	15.5	15.6	15.1	14.3	12.9	13.1	12.3	12.1	100
105	10.4	14.4	14.8	15	15.1	14.6	13.9	12.6	12.8	12	11.9	105
110	9.8	13.8	14.2	14.4	14.6	14.2	13.5	12.3	12.5	11.8	11.7	110
115	9.3	13.2	13.7	13.9	14.1	13.8	13.2	12	12.2	11.6	11.5	115
120	8.9	12.7	13.2	13.4	13.6	13.4	12.8	11.7	12	11.4	11.3	120
125	8.5	12.2	12.7	12.9	13.2	13	12.5	11.4	11.7	11.1	11	125
130	8.1	11.7	12.2	12.5	12.8	12.6	12.2	11.1	11.4	10.9	10.8	130
135	7.8	11.3	11.8	12.1	12.4	12.3	11.9	10.8	11.2	10.7	10.6	135
140	7.6	10.8	11.4	11.7	12.1	11.9	11.6	10.5	10.9	10.4	10.4	140
145		10.4	10.9	11.3	11.7	11.6	11.3	10.2	10.6	10.2	10.2	145
150		10	10.6	10.9	11.3	11.3	11	9.9	10.3	9.9	9.9	150
155		9.7	10.2	10.5	11	11	10.8	9.6	10.1	9.7	9.7	155
160		9.3	9.8	10.2	10.7	10.7	10.5	9.4	9.8	9.4	9.4	160
165		9	9.5	9.9	10.4	10.5	10.3	9.1	9.5	9.2	9.2	165
170		8.7	9.2	9.5	10.2	10.2	10.1	8.8	9.2	8.9	8.9	170
175		8.4	8.9	9.2	9.9	10	9.8	8.6	9	8.7	8.7	175
180		8.2	8.6	9	9.6	9.7	9.6	8.4	8.8	8.5	8.5	180
185		8	8.4	8.7	9.4	9.5	9.4	8.2	8.6	8.3	8.3	185
190		7.8	8.1	8.5	9.1	9.3	9.2	8	8.3	8.1	8.1	190
195		7.6	7.9	8.3	8.9	9	9	7.8	8.1	7.9	7.9	195
200			7.8	8.1	8.7	8.8	8.8	7.6	8	7.7	7.7	200
205			7.6	7.9	8.5	8.6	8.6	7.5	7.8	7.6	7.6	205
210			7.5	7.7	8.3	8.4	8.4	7.3	7.6	7.4	7.4	210
215				7.5	8.1	8.3	8.3	7.2	7.5	7.3	7.3	215
220				7.4	7.9	8.1	8.1	7.1	7.4	7.2	7.2	220
225				6.6	7.8	8	8	7	7.2	7.1	7.1	225
230					7.7	7.8	7.8	6.8	7.1	7	7	230
235					7.6	7.7	7.7	6.7	7	6.8	6.9	235
240					6.5	7.6	7.6	6.6	6.9	6.7	6.8	240
245						7.5	7.4	6.5	6.8	6.6	6.6	245
250						6.5	7	6.3	6.7	6.5	6.5	250
255						3.9	6.7	6.2	6.6	6.4	6.4	255
260							6.5	6	6.4	6.2	6.2	260
265							4.9	5.9	6.1	6	5.8	265
270								5.7	5.6	5.7	5.5	270
275								4	4.4	5.3	5.2	275
280									2.5	4.8	4.9	280
285										3.5	3.9	285
290											2.3	290

t_259_105_18151 / 38151_00_000

Lifting capacities

Forces de levage

TS 128 ft

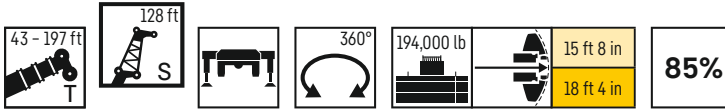

	43 ft	99 ft	114 ft	128 ft	142 ft	156 ft	170 ft	180 ft	184 ft	194 ft	197 ft	
	128 ft											
28	21.9											28
30	21.7											30
32	21.2											32
34	20.7											34
36	20.2											36
38	19.7											38
40	19.2	21.7										40
45	18	20.8	20.3									45
50	16.8	19.8	19.5	18.7	17.5							50
55	15.8	18.9	18.7	18	17	15.7						55
60	14.8	18	17.9	17.3	16.5	15.2	13.6					60
65	13.9	17.2	17.1	16.7	15.9	14.8	13.3	11.4	11.6			65
70	13.1	16.3	16.3	16	15.4	14.3	13	11.2	11.4	10.4	10.2	70
75	12.3	15.6	15.6	15.4	14.8	13.9	12.7	10.9	11.1	10.2	10	75
80	11.6	14.8	15	14.7	14.3	13.5	12.3	10.7	10.9	10	9.9	80
85	10.9	14.2	14.3	14.2	13.8	13	12	10.5	10.7	9.8	9.7	85
90	10.3	13.5	13.7	13.6	13.2	12.6	11.7	10.3	10.4	9.6	9.5	90
95	9.7	12.9	13.1	13.1	12.8	12.2	11.4	10	10.2	9.4	9.3	95
100	9.2	12.3	12.6	12.6	12.3	11.8	11	9.8	10	9.2	9.1	100
105	8.7	11.8	12	12.1	11.9	11.5	10.7	9.5	9.7	9.1	8.9	105
110	8.2	11.3	11.6	11.6	11.5	11.1	10.4	9.3	9.5	8.9	8.8	110
115	7.8	10.8	11.1	11.2	11.1	10.7	10.1	9.1	9.3	8.7	8.6	115
120	7.5	10.3	10.7	10.7	10.7	10.4	9.8	8.9	9	8.5	8.4	120
125	7.1	9.9	10.2	10.4	10.3	10.1	9.5	8.6	8.8	8.3	8.2	125
130	6.8	9.5	9.8	10	9.9	9.7	9.2	8.4	8.6	8.1	8	130
135	6.5	9.1	9.4	9.6	9.6	9.4	9	8.2	8.4	8	7.9	135
140	6.2	8.7	9.1	9.3	9.3	9.1	8.8	8	8.2	7.8	7.7	140
145	6	8.4	8.7	8.9	9	8.9	8.5	7.8	8	7.6	7.5	145
150	5.7	8.1	8.4	8.6	8.7	8.6	8.3	7.6	7.8	7.5	7.4	150
155	5.5	7.8	8.1	8.3	8.4	8.3	8.1	7.4	7.6	7.3	7.2	155
160	5.3	7.5	7.8	8	8.1	8.1	7.9	7.2	7.4	7.2	7.1	160
165	5.2	7.2	7.6	7.8	7.9	7.8	7.6	7.1	7.3	7	7	165
170		7	7.3	7.5	7.6	7.6	7.5	6.9	7.1	6.9	6.8	170
175		6.7	7.1	7.3	7.4	7.4	7.3	6.7	6.9	6.7	6.7	175
180		6.5	6.8	7.1	7.2	7.2	7.1	6.5	6.8	6.6	6.5	180
185		6.3	6.6	6.9	7	7	6.9	6.4	6.6	6.4	6.4	185
190		6.1	6.4	6.7	6.8	6.8	6.7	6.2	6.5	6.2	6.2	190
195		5.9	6.3	6.5	6.6	6.6	6.6	6.1	6.3	6.1	6.1	195
200		5.8	6.1	6.3	6.5	6.5	6.5	5.9	6.2	6	6	200
205		5.6	5.9	6.1	6.3	6.4	6.3	5.8	6	5.8	5.8	205
210		5.5	5.7	6	6.1	6.2	6.2	5.6	5.9	5.7	5.7	210
215		5.3	5.6	5.8	6	6.1	6	5.5	5.7	5.6	5.6	215
220		5.3	5.5	5.7	5.8	5.9	5.9	5.4	5.6	5.5	5.5	220
225			5.3	5.5	5.7	5.8	5.8	5.3	5.5	5.3	5.4	225
230			5.3	5.4	5.6	5.7	5.7	5.2	5.4	5.2	5.3	230
235			5.2	5.3	5.5	5.6	5.6	5	5.3	5.1	5.1	235
240				5.2	5.3	5.5	5.5	4.9	5.2	5	5	240
245				5.2	5.3	5.3	5.4	4.8	5.1	4.9	4.9	245
250				4.5	5.2	5.3	5.3	4.8	5	4.9	4.9	250
255					5.1	5.2	5.2	4.7	4.9	4.8	4.8	255
260					4.9	5.1	5.1	4.6	4.8	4.7	4.7	260
265						5	5	4.5	4.7	4.6	4.6	265
270						5	5	4.5	4.6	4.5	4.6	270
275						4.3	4.9	4.4	4.6	4.5	4.5	275
280							4.5	4.4	4.5	4.4	4.4	280
285							4.2	4.3	4.5	4.4	4.3	285
290								4.2	4.4	4.2	4	290
295								3.3	3.3	3.9	3.7	295
300										3.5	3.4	300
305										2.4	2.6	305

t_259_105_22151 / 42151_00_000

Lifting capacities

Forces de levage

TS 151 ft

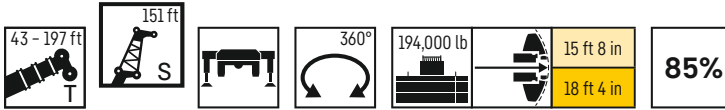

	43 ft	99 ft	114 ft	128 ft	142 ft	156 ft 151 ft	170 ft	180 ft	184 ft	194 ft	197 ft	
32	15.4											32
34	15.3											34
36	15.1											36
38	14.9											38
40	14.6											40
45	14	15.2										45
50	13.4	14.8	14.4	13.7								50
55	12.7	14.3	14	13.4	12.7							55
60	11.9	13.9	13.6	13.1	12.4	11.4						60
65	11.3	13.4	13.2	12.7	12	11.1	9.9					65
70	10.6	12.8	12.7	12.3	11.7	10.8	9.7	8.2	8.4			70
75	10	12.2	12.2	11.8	11.3	10.5	9.5	8	8.2	7.4	7.3	75
80	9.5	11.7	11.7	11.4	10.9	10.2	9.2	7.9	8	7.3	7.2	80
85	8.9	11.2	11.2	11	10.6	9.9	9	7.7	7.8	7.2	7.1	85
90	8.4	10.7	10.7	10.6	10.2	9.6	8.8	7.6	7.7	7.1	7	90
95	8	10.2	10.3	10.2	9.8	9.3	8.5	7.4	7.5	7	6.9	95
100	7.5	9.8	9.9	9.8	9.5	9	8.3	7.3	7.4	6.9	6.8	100
105	7.1	9.4	9.5	9.4	9.1	8.7	8	7.1	7.2	6.7	6.7	105
110	6.8	8.9	9.1	9	8.8	8.4	7.8	7	7.1	6.6	6.5	110
115	6.4	8.5	8.7	8.7	8.5	8.2	7.6	6.8	6.9	6.5	6.4	115
120	6.1	8.2	8.4	8.3	8.2	7.9	7.4	6.7	6.8	6.4	6.3	120
125	5.8	7.8	8	8	7.9	7.6	7.2	6.5	6.6	6.2	6.2	125
130	5.6	7.5	7.7	7.7	7.4	7.4	7	6.4	6.5	6.1	6	130
135	5.3	7.2	7.4	7.5	7.4	7.2	6.8	6.2	6.3	6	5.9	135
140	5.1	6.9	7.1	7.2	7.2	7	6.7	6.1	6.2	5.8	5.8	140
145	4.8	6.7	6.9	7	6.9	6.8	6.5	5.9	6	5.7	5.7	145
150	4.6	6.4	6.6	6.7	6.7	6.6	6.3	5.8	5.9	5.6	5.5	150
155	4.4	6.2	6.4	6.5	6.5	6.4	6.1	5.6	5.8	5.5	5.4	155
160	4.2	5.9	6.2	6.3	6.3	6.2	6	5.5	5.6	5.3	5.3	160
165	4	5.7	5.9	6.1	6.1	6	5.8	5.4	5.5	5.2	5.2	165
170	3.9	5.5	5.7	5.9	5.9	5.9	5.7	5.3	5.3	5.1	5.1	170
175	3.7	5.3	5.5	5.7	5.8	5.7	5.5	5.1	5.2	5	5	175
180	3.6	5.1	5.3	5.5	5.6	5.5	5.4	5	5.1	4.9	4.9	180
185	3.5	4.9	5.1	5.3	5.4	5.4	5.2	4.9	5	4.8	4.8	185
190		4.7	5	5.1	5.2	5.2	5.1	4.8	4.9	4.7	4.7	190
195		4.6	4.8	5	5.1	5.1	4.9	4.7	4.7	4.6	4.6	195
200		4.4	4.6	4.8	4.9	4.9	4.8	4.6	4.6	4.5	4.5	200
205		4.3	4.5	4.7	4.8	4.8	4.7	4.4	4.5	4.4	4.4	205
210		4.1	4.4	4.5	4.6	4.7	4.6	4.3	4.4	4.3	4.3	210
215		4	4.2	4.4	4.5	4.5	4.5	4.2	4.3	4.2	4.2	215
220		3.9	4.1	4.2	4.4	4.4	4.4	4.1	4.2	4.1	4.1	220
225		3.8	4	4.1	4.2	4.3	4.2	4	4.1	4	4	225
230		3.7	3.8	4	4.1	4.2	4.1	3.9	4	3.9	3.9	230
235		3.5	3.7	3.9	4	4.1	4	3.8	3.9	3.8	3.8	235
240		3.5	3.6	3.8	3.9	4	4	3.7	3.8	3.7	3.7	240
245		3.4	3.5	3.7	3.8	3.9	3.9	3.6	3.7	3.7	3.7	245
250			3.5	3.6	3.7	3.8	3.8	3.5	3.7	3.6	3.6	250
255			3.4	3.5	3.6	3.7	3.7	3.4	3.6	3.5	3.5	255
260				3.4	3.5	3.6	3.6	3.3	3.5	3.4	3.4	260
265				3.4	3.4	3.5	3.5	3.3	3.4	3.3	3.3	265
270				3.4	3.4	3.4	3.5	3.2	3.3	3.3	3.3	270
275					3.3	3.4	3.4	3.1	3.3	3.2	3.2	275
280					3.3	3.3	3.3	3	3.2	3.1	3.1	280
285					3	3.3	3.3	3	3.1	3.1	3.1	285
290						3.2	3.2	2.9	3.1	3	3	290
295						3	3.2	2.9	3	2.9	2.9	295
300							3	2.9	3	2.9	2.9	300
305							2.9	2.8	2.9	2.8	2.8	305
310								2.8	2.8	2.7	2.5	310
315								2.3		2.5	2.3	315

t 259_105_22151 / 42151_00_000

Lifting heights

Hauteurs de levage

TNZF

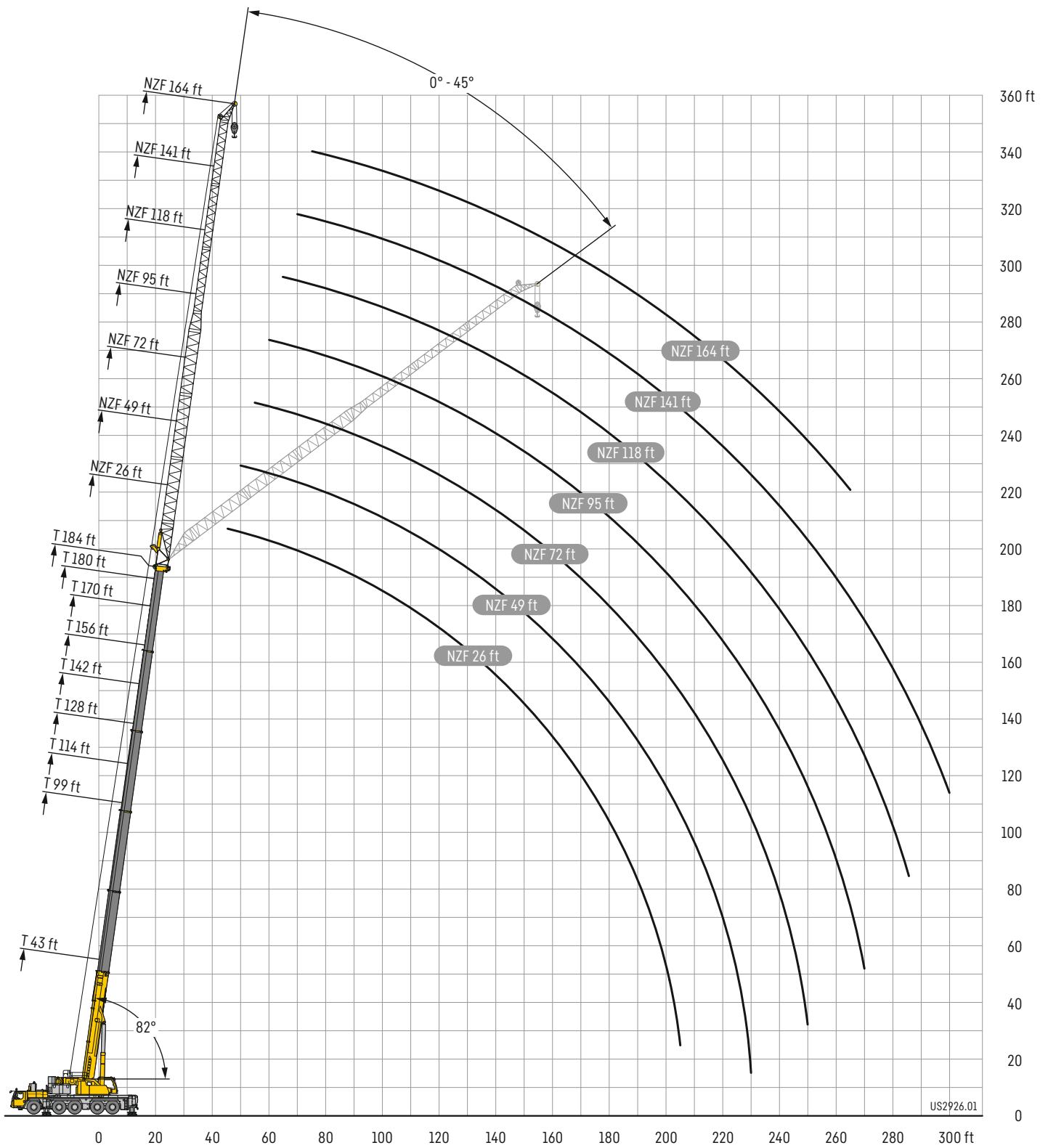

Lifting capacities

Forces de levage

TNZF 26 ft

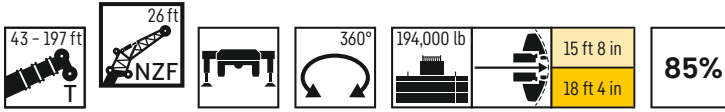

	43 ft + 3.3 ft*			99 ft + 3.3 ft*			114 ft + 3.3 ft*			128 ft + 3.3 ft*			142 ft + 3.3 ft*			156 ft + 3.3 ft*			
	26 ft																		
	0°	22,5°	45°	0°	22,5°	45°	0°	22,5°	45°	0°	22,5°	45°	0°	22,5°	45°	0°	22,5°	45°	
10	90.9																		10
11	90.9																		11
12	90.9																		12
13	90.9																		13
14	90																		14
15	88.5																		15
16	86.7																		16
17	85																		17
18	83.3																		18
19	81.6																		19
20	80.1	62.8																	20
22	76.9	61.9		90.9															22
24	73.9	60.1		90.9			88.5												24
26	70.9	58.2		89.7			87												26
28	68.1	56.5	49.3	87.7			85.5			79.2									28
30	65.3	54.9	48.4	85.8			83.9			78.3									30
32	62.6	53.4	47.5	83.9	62.1		82.4			77.3			69.9						32
34	60	52	46.6	82	61.1		80.9	60.8		76.3			69.3						34
36	57.5	50.5	45.8	80.3	60.1		79.4	59.9		75.2			68.7			60.2			36
38	55.2	48.9	44.9	78.5	59.1	49.2	78	59		74.2	57.8		68			59.9			38
40	53.2	47.5	44	76.7	58.1	48.7	76.4	58.2		73	57.1		67.3			59.5			40
45	48.6	44.2	41.8	72.6	55.8	47.5	72.7	56	47.5	70	55.2	47	65.1	53.4		58.3			45
50	44.8	41.4	40	68.6	53.7	46.4	69.3	54.1	46.5	67.2	53.4	46.2	63.1	51.8	45.4	57.1	49.4		50
55	41.7	39.3	38.8	64.7	51.9	45.4	66.2	52.3	45.6	64.7	51.9	45.3	61.2	50.5	44.7	55.8	48.3	43.8	55
60	39	37.7	38.6	61.1	49.8	44.2	63.3	50.7	44.8	62.3	50.4	44.6	59.1	49.2	44	54.2	47.3	43.1	60
65	36.8	36.9		57.6	47.9	43.1	60.5	49.1	43.8	60	49.1	43.9	56.8	48	43.4	51.6	46.3	42.6	65
70				54.5	46	42	57.6	47.5	42.8	57.8	47.8	43.1	54.2	47	42.9	49	45.4	42.1	70
75				51.7	44.3	41.1	54.7	46	41.8	54.8	46.6	42.3	51.1	46	42.3	46.6	44.4	41.7	75
80				49.4	42.8	40.3	52.4	44.5	41.1	51.3	45.3	41.5	47.8	45.1	41.5	44.3	42.8	41.2	80
85				47.1	41.5	39.5	50.1	43.1	40.3	48	44.1	40.7	45	44.2	40.8	42.1	40.9	40.2	85
90				45.1	40.3	39	48	41.9	39.7	45.1	42.8	40.1	42.2	42.5	40.2	40	39.1	38.7	90
95				43.3	39.3	38.7	45.4	40.8	39.2	42.2	41.4	39.5	39.7	40.2	39.1	37.8	37.4	37.3	95
100				41.7	38.5	38.6	42.2	39.8	38.8	39.9	40	39.1	37.5	37.9	37.8	35.7	35.7	35.7	100
105				40.2	37.8	38.6	39.1	39	38.5	37.5	38.1	38.2	35.3	35.8	36.3	33.7	34.1	34.2	105
110				38	37.2	38.3	36.4	37.1	37.3	34.9	35.7	36.1	33.3	33.8	34.3	31.9	32.4	32.7	110
115				35.6	35.8	35.6	33.9	34.5	34.6	32.3	33.2	33.5	31.5	32	32.4	30.2	30.7	31.1	115
120				30.5	31.8		31.7	32.1	32.1	30.1	30.8	31	30	30.2	30.6	28.6	29.1	29.5	120
125							29.6	30	29.8	28	28.6	28.8	28.8	28.5	28.7	27.1	27.5	27.9	125
130							27.7	28	27	26.2	26.7	26.7	27	27.4	27.6	25.6	26.1	26.5	130
135							22.1	22.5		24.4	24.8	24.8	25.2	25.7	25.9	24	24.6	24.9	135
140										22.8	23.1	22.9	23.6	24	24.1	22.8	23	23.2	140
145										21	21.6		22.1	22.5	22.5	22	21.9	22.2	145
150										15.9	16.2		20.7	21	20.9	20.9	21.2	21.3	150
155													19.5	19.7	19.4	19.7	20	20	155
160													17.2	17.9		18.5	18.8	18.7	160
165													13.7			17.4	17.6	17.5	165
170																16.3	16.5		170
175																15	15.3		175
180																8.1			180

* adapter - pièce d'adaptateur

t_259_104_10151 / 30151_00_000

Lifting capacities

Forces de levage

TNZF 26 ft

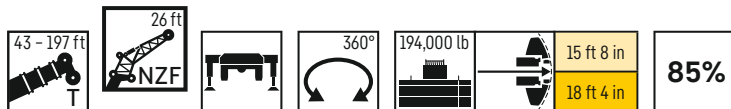

	170 ft + 3.3 ft*			180 ft + 3.3 ft*			184 ft + 3.3 ft*			194 ft + 3.3 ft*			197 ft + 3.3 ft*			
	0°	22,5°	45°	0°	22,5°	45°	0°	22,5°	45°	0°	22,5°	45°	0°	22,5°	45°	
40	51.2															40
45	50.6			39.7			42									45
50	49.5			38.6			40.9			35.5			34.8			50
55	47.6	44.7		37.5	35.5		39.7			34.8			34.1			55
60	45.6	43.7	41.4	36.2	34.2		38.5	35.9		34	33		33.4	32.6		60
65	43.7	42	40.9	34.9	32.9	31.5	37.1	34.6	33.1	33.1	32		32.7	31.7		65
70	41.8	40.2	39.8	33.5	31.7	30.4	35.7	33.4	32.1	32.2	31	29.8	31.8	30.7	29.7	70
75	40.1	38.6	38.2	32	30.5	29.4	34.3	32.2	31.1	31.1	29.9	28.9	30.8	29.8	28.8	75
80	38.4	37	36.7	30.7	29.4	28.5	33	31.2	30.1	30	28.9	28.1	29.7	28.7	28	80
85	36.8	35.6	35.3	29.5	28.3	27.6	31.8	30.2	29.2	28.9	27.9	27.3	28.6	27.7	27.2	85
90	35.3	34.2	34	28.2	27.3	26.8	30.5	29.2	28.4	27.8	26.9	26.5	27.6	26.8	26.4	90
95	33.9	32.8	32.8	27	26.3	25.9	29.4	28.3	27.6	26.7	26	25.7	26.6	25.9	25.7	95
100	32.5	31.7	31.6	25.8	25.3	25.1	28.3	27.4	26.9	25.7	25.1	25	25.5	25	24.9	100
105	31.2	30.5	30.5	24.7	24.3	24.2	27.3	26.6	26.2	24.7	24.2	24.2	24.6	24.2	24.1	105
110	29.9	29.4	29.4	23.7	23.4	23.4	26.3	25.8	25.5	23.7	23.4	23.4	23.6	23.4	23.3	110
115	28.6	28.3	28.4	22.6	22.5	22.6	25.4	24.9	24.9	22.8	22.6	22.6	22.7	22.5	22.6	115
120	27.3	27.2	27.4	21.7	21.6	21.7	24.5	24.1	24.2	22	21.8	21.9	21.9	21.7	21.8	120
125	26	26.2	26.4	20.8	20.7	20.9	23.6	23.3	23.5	21.1	21	21.1	21.1	21	21.1	125
130	24.7	25.1	25.4	20	19.9	20.1	22.9	22.6	22.8	20.3	20.2	20.4	20.3	20.2	20.4	130
135	23.5	24	24.3	19.2	19.2	19.3	22.1	21.9	22.1	19.6	19.5	19.7	19.6	19.5	19.7	135
140	22.4	22.8	23.1	18.4	18.4	18.6	21.3	21.2	21.4	18.9	18.8	19	18.9	18.8	19	140
145	21.1	21.6	21.9	17.7	17.7	17.9	20.6	20.5	20.8	18.2	18.1	18.4	18.2	18.2	18.4	145
150	19.8	20.3	20.5	17	17	17.2	19.9	19.9	20.1	17.5	17.5	17.7	17.5	17.5	17.8	150
155	18.7	19	19.1	16.4	16.4	16.6	19.1	19.3	19.5	16.9	16.9	17.1	16.9	16.9	17.2	155
160	18	18.1	18.3	15.8	15.8	16	18	18.5	18.7	16.3	16.3	16.6	16.2	16.4	16.6	160
165	17.4	17.5	17.8	15.2	15.3	15.4	16.9	17.3	17.4	15.8	15.8	16	15.6	15.8	16	165
170	16.8	16.9	17.2	14.6	14.7	14.9	15.8	16.2	16.3	15.2	15.3	15.5	15	15.2	15.4	170
175	15.9	16.2	16.1	14.1	14.2	14.4	14.8	15.2	15.2	14.7	14.8	15	14.4	14.6	14.8	175
180	15	15.2	15	13.5	13.6	13.8	13.9	14.2	14.2	13.9	14.2	14.3	13.7	14	14.1	180
185	14	14.2		13.1	13.1	13.3	13	13.3	13.2	13	13.3	13.3	12.8	13.2	13.2	185
190	10.9	11.1		12.6	12.7		12.2	12.4	12.2	12.2	12.5	12.4	12	12.3	12.3	190
195				12.1	12.3		11.4	11.5		11.4	11.6	11.5	11.2	11.5	11.4	195
200				9.2	9.3		10.2	10.5		10.7	10.8	10.7	10.5	10.7	10.6	200
205							7	6.9		10	10.1		9.8	9.9	9.8	205
210										8.6	9		9	9.2		210
215										5.8			6.8	7		215
220													3			220

* adapter · pièce d'adaptateur

t_259_104_10151 / 30151_00_000

Lifting capacities

Forces de levage

TNZF 49 ft

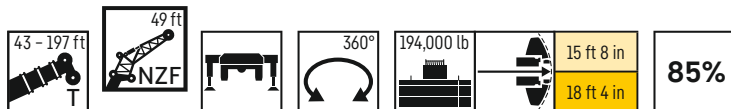

	43 ft + 3.3 ft*			99 ft + 3.3 ft*			114 ft + 3.3 ft*			128 ft + 3.3 ft*			142 ft + 3.3 ft*			156 ft + 3.3 ft*			
	49 ft																		
	0°	22,5°	45°	0°	22,5°	45°	0°	22,5°	45°	0°	22,5°	45°	0°	22,5°	45°	0°	22,5°	45°	
14	60.9																		14
15	60.9																		15
16	60.2																		16
17	59.1																		17
18	58																		18
19	57																		19
20	56																		20
22	54																		22
24	51.9																		24
26	49.9			60.1															26
28	48			58.7			57												28
30	46.2			57.4			56												30
32	44.4			56.1			55			51.8									32
34	42.7	32.1		54.9			54			51.1									34
36	41	31		53.6			52.9			50.4			46						36
38	39.3	30		52.4			51.8			49.5			45.7						38
40	37.6	29		51.1			50.7			48.6			45.3			40.7			40
45	34.1	26.8		48	31.8		48			46.4			43.7			39.6			45
50	31	25	20.9	45.2	30.2		45.5	30.5		44.3	30.4		42.1			38.5			50
55	28.4	23.5	20	42.6	28.7		43.2	29.1		42.3	29.2		40.6	29.7		37.4			55
60	26.2	22.1	19.3	40	27.4	21.1	41.1	27.9	21.2	40.5	28		39.1	28.6		36.3	27.9		60
65	24.3	21	18.7	37.3	26.2	20.6	39	26.8	20.7	38.9	27	20.7	37.7	27.5		35.2	27		65
70	22.7	20	18.2	35.1	25.2	20.1	36.7	25.8	20.2	37.2	26	20.2	36.4	26.6	20.6	34.2	26.2		70
75	21.2	19.2	18.1	33.1	24.2	19.6	34.7	24.8	19.8	35.5	25.1	19.8	35.2	25.7	20.3	33.3	25.4	20.1	75
80	20	18.5	18.1	31.2	23.3	19.3	32.9	24	19.4	33.8	24.3	19.5	34	25	19.9	32.3	24.7	19.8	80
85	18.9	18.2		29.5	22.6	18.9	31.2	23.2	19.1	32.2	23.5	19.2	32.8	24.2	19.6	31.5	24	19.5	85
90	18.2			28	21.8	18.6	29.7	22.5	18.8	30.8	22.8	18.9	31.5	23.6	19.3	30.6	23.4	19.2	90
95				26.6	21.2	18.4	28.3	21.8	18.5	29.3	22.2	18.6	30.4	22.9	19	29.7	22.8	19	95
100				25.3	20.6	18.2	27	21.2	18.3	28.1	21.6	18.4	29.2	22.3	18.8	28.8	22.3	18.7	100
105				24.3	20	18.1	25.9	20.6	18.2	27	21	18.2	28.1	21.8	18.6	27.9	21.8	18.5	105
110				23.2	19.5	18.1	24.8	20.1	18	25.9	20.5	18.1	27.1	21.3	18.4	27	21.3	18.4	110
115				22.3	19.1	18.1	23.8	19.7	17.9	24.9	20.1	17.9	26.1	20.8	18.3	26.1	20.8	18.2	115
120				21.4	18.7	18.1	22.9	19.3	17.9	24	19.7	17.9	25.2	20.4	18.2	25.3	20.4	18.1	120
125				20.6	18.4	18.1	22	18.9	17.9	23.2	19.3	17.8	24.4	20	18.1	24.6	20.1	18.1	125
130				19.9	18.3		21.2	18.6	17.9	22.4	18.9	17.8	23.6	19.6	18.1	23.8	19.7	18	130
135				19.2	18.2		20.5	18.3	17.9	21.7	18.6	17.8	22.8	19.3	18.1	23.1	19.4	18	135
140				18.6	18.2		19.9	18.2	17.9	21	18.4	17.8	22.2	19	18.1	22.2	19.1	18	140
145				18.2			19.3	18.1		20.4	18.2	17.8	21.6	18.8	18.1	21.4	18.9	18	145
150							18.8	18.1		19.8	18	17.8	20.8	18.6	18.1	20.4	18.7	18	150
155							18.4	18.1		19.3	18	17.8	20.2	18.4	18.1	19.1	18.5	18	155
160							12.9			18.6	18		19.1	18.3	18.1	17.9	18.3	18	160
165										17.4	17.8		18	18.2	18.1	16.9	17.6	17.9	165
170										14.3	15.7		16.9	17.4	17.3	16.3	16.4	16.7	170
175										9.2			15.9	16.3		15.7	15.8	16.2	175
180													14.8	15.3		15	15.3	15.5	180
185													12	11		14.2	14.6	13.1	185
190																13.3	13.7		190
195																12	12.8		195
200																9.7			200

* adapter · pièce d'adaptateur

t_259_104_11151 / 31151_00_000

Lifting capacities

Forces de levage

TNZF 49 ft

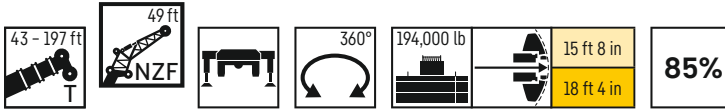

	170 ft + 3.3 ft*			180 ft + 3.3 ft*			184 ft + 3.3 ft*			194 ft + 3.3 ft*			197 ft + 3.3 ft*				
	0°	22,5°	45°	0°	22,5°	45°	0°	22,5°	45°	0°	22,5°	45°	0°	22,5°	45°		
45	34.8															45	
50	34.1			29.2			29.5									50	
55	33.4			28.7			29.1				26.3			25.6		55	
60	32.7			28.3			28.6				25.9			25.3		60	
65	32	26		27.6			28.2				25.6			25.1		65	
70	31.3	25.3		26.8	23		27.8	23.7			25.3			24.8		70	
75	30.6	24.7		26	22.3		27.3	23			24.7	22		24.4	21.8	75	
80	29.9	24	19.5	25.2	21.7		26.6	22.4			24.1	21.4		23.9	21.3	80	
85	29.2	23.4	19.2	24.4	21.1	18.5	25.7	21.8	18.8		23.6	20.9		23.3	20.8	85	
90	28.6	22.9	19	23.5	20.6	18.2	24.9	21.2	18.6		22.9	20.4	18.1	22.7	20.3	18	90
95	28	22.4	18.8	22.7	20.1	17.9	24	20.7	18.3		22.3	19.9	17.8	22.1	19.8	17.8	95
100	27.2	21.9	18.6	21.9	19.6	17.6	23.2	20.2	18.1		21.6	19.5	17.5	21.5	19.4	17.5	100
105	26.3	21.4	18.4	21.1	19.1	17.3	22.4	19.8	17.8		20.9	19	17.3	20.8	19	17.2	105
110	25.4	21	18.3	20.3	18.6	17.1	21.7	19.4	17.6		20.1	18.6	17	20.1	18.5	17	110
115	24.5	20.6	18.1	19.6	18.1	16.9	21	19	17.4		19.5	18.1	16.8	19.4	18	16.8	115
120	23.7	20.2	18	18.9	17.6	16.7	20.4	18.6	17.2		18.8	17.6	16.6	18.8	17.5	16.6	120
125	22.8	19.9	17.9	18.2	17.1	16.5	19.8	18.2	17		18.2	17.1	16.4	18.2	17.1	16.4	125
130	22	19.6	17.9	17.6	16.7	16.2	19.2	17.8	16.8		17.6	16.7	16.2	17.5	16.7	16.2	130
135	21.3	19.3	17.8	16.9	16.2	15.9	18.6	17.4	16.6		17	16.3	16	17	16.3	15.9	135
140	20.6	19.1	17.8	16.3	15.8	15.6	18	16.9	16.5		16.4	15.9	15.7	16.4	15.9	15.6	140
145	19.9	18.8	17.8	15.6	15.4	15.3	17.5	16.5	16.2		15.8	15.5	15.4	15.8	15.5	15.3	145
150	19.2	18.6	17.8	15	14.9	15	16.9	16.1	16		15.3	15.1	15.1	15.3	15.1	15	150
155	18.6	18.3	17.8	14.4	14.5	14.6	16.4	15.8	15.8		14.8	14.7	14.7	14.8	14.7	14.7	155
160	17.8	17.9	17.8	13.9	14	14.2	15.9	15.4	15.5		14.2	14.2	14.4	14.2	14.3	14.4	160
165	16.9	17.4	17.6	13.4	13.5	13.8	15.4	15.1	15.3		13.7	13.8	14	13.7	13.8	14.1	165
170	15.8	16.7	17	12.9	13	13.3	15	14.8	15		13.3	13.3	13.6	13.3	13.4	13.7	170
175	14.8	15.6	15.9	12.4	12.5	12.8	14.5	14.4	14.8		12.8	12.9	13.2	12.8	12.9	13.2	175
180	13.9	14.6	14.8	12	12.1	12.4	14.1	14.1	14.5		12.4	12.5	12.8	12.4	12.5	12.8	180
185	13.3	13.6	13.8	11.5	11.6	11.9	13.4	13.7	14.2		12	12.1	12.4	12	12.1	12.4	185
190	12.9	13	13.5	11.1	11.2	11.5	12.5	13.2	13.4		11.6	11.7	12	11.6	11.7	12	190
195	12.5	12.7	13.1	10.7	10.9	11.2	11.7	12.3	12.5		11.2	11.3	11.6	11.2	11.4	11.7	195
200	12.1	12.3		10.4	10.5	10.8	11	11.5	11.6		10.8	11	11.3	10.7	11	11.3	200
205	11.4	11.7		10	10.2	10.5	10.3	10.8	10.7		10.2	10.7	10.8	10	10.6	10.7	205
210	9.6	10.6		9.7	9.9		9.6	10	9.9		9.6	10	10.1	9.4	9.9	9.9	210
215	6.3			9.4	9.6		9	9.3			8.9	9.4	9.3	8.7	9.2	9.2	215
220				8.1	8.9		8.2	8.6			8.3	8.7	8.5	8.1	8.5	8.4	220
225				5.2			6.4				7.8	8		7.6	7.9		225
230							3.3				7	7.5		7.1	7.3		230
235											5.3			5.9	6.5		235
240														3.6			240

* adapter - pièce d'adaptateur

t_259_104_11151 / 31151_00_000

Lifting capacities

Forces de levage

TNZF 72 ft

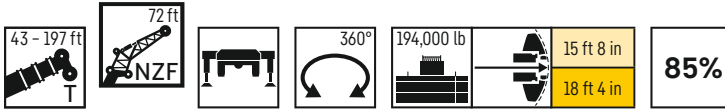

	43 ft + 3.3 ft*			99 ft + 3.3 ft*			114 ft + 3.3 ft*			128 ft + 3.3 ft*			142 ft + 3.3 ft*			156 ft + 3.3 ft*			
	72 ft																		
	0°	22,5°	45°	0°	22,5°	45°	0°	22,5°	45°	0°	22,5°	45°	0°	22,5°	45°	0°	22,5°	45°	
18	43																		18
19	43																		19
20	42.6																		20
22	41.4																		22
24	40.1																		24
26	38.8																		26
28	37.5																		28
30	36.1			42.5															30
32	34.9			41.7			40.5												32
34	33.7			40.9			39.8												34
36	32.6			40			39.1			37									36
38	31.6			39.2			38.4			36.4									38
40	30.6			38.3			37.6			35.8			33.1						40
45	28.3	23.7		36			35.6			34.2			32			29.1			45
50	26.2	22.6		34			33.8			32.7			30.8			28.2			50
55	24.3	21.2		32.1			32.1			31.2			29.7			27.4			55
60	22.5	20		30.4	23		30.6	22.8		29.9			28.6			26.5			60
65	20.8	18.9		28.9	22		29.2	22		28.6	21.8		27.5			25.7			65
70	19.1	18	16.3	27.4	21.1		27.8	21.2		27.4	21		26.5	20.6		24.9			70
75	17.7	17.1	15.6	26.1	20.3		26.6	20.5		26.3	20.3		25.5	19.9		24.1	19.3		75
80	16.5	16.3	15	24.8	19.6	16.5	25.4	19.8	16.6	25.3	19.7		24.6	19.4		23.4	18.8		80
85	15.4	15.5	14.5	23.6	19	16.1	24.3	19.1	16.1	24.3	19.1	16.1	23.8	18.8		22.7	18.3		85
90	14.4	14.8	14.1	22.3	18.3	15.7	23.3	18.5	15.8	23.4	18.5	15.7	23	18.3	15.6	22	17.8		90
95	13.6	14.2	13.8	21.2	17.8	15.3	22.3	18	15.4	22.5	18	15.4	22.2	17.8	15.3	21.4	17.4	15.1	95
100	12.8	13.7	13.6	20	17.2	15	21.3	17.5	15.1	21.8	17.5	15.1	21.5	17.3	15	20.7	17	14.8	100
105	12.2	13.3	13.6	19	16.7	14.7	20.3	17	14.8	21	17	14.8	20.8	16.9	14.7	20.2	16.6	14.6	105
110	11.6	13.2		18.1	16.2	14.4	19.3	16.5	14.5	20.2	16.6	14.5	20.2	16.5	14.5	19.6	16.2	14.3	110
115				17.1	15.7	14.2	18.4	16.1	14.3	19.3	16.2	14.3	19.5	16.1	14.3	19.1	15.9	14.1	115
120				16.4	15.2	14	17.6	15.6	14.1	18.5	15.8	14.1	18.9	15.8	14.1	18.6	15.6	13.9	120
125				15.7	14.8	13.8	16.8	15.2	13.9	17.7	15.5	13.9	18.3	15.4	13.9	18.1	15.2	13.8	125
130				15	14.5	13.7	16.1	14.8	13.8	17	15.1	13.8	17.6	15.1	13.7	17.6	14.9	13.6	130
135				14.4	14.1	13.7	15.5	14.5	13.6	16.4	14.8	13.6	17	14.8	13.6	17.1	14.7	13.5	135
140				13.8	13.8	13.6	14.9	14.2	13.6	15.8	14.4	13.5	16.4	14.5	13.5	16.6	14.4	13.4	140
145				13.3	13.6	13.6	14.3	13.9	13.5	15.2	14.1	13.5	15.8	14.2	13.4	16.1	14.1	13.3	145
150				12.8	13.4		13.8	13.6	13.5	14.6	13.9	13.4	15.3	14	13.3	15.6	13.9	13.2	150
155				12.3	13.2		13.3	13.4	13.5	14.1	13.6	13.4	14.8	13.7	13.3	15.2	13.7	13.1	155
160				11.9	13.2		12.9	13.2		13.7	13.4	13.4	14.3	13.5	13.2	14.7	13.5	13.1	160
165				11.6	13.2		12.4	13.1		13.2	13.2	13.4	13.9	13.3	13.2	14.3	13.3	13.1	165
170							12.1	13.1		12.8	13.1	13.4	13.5	13.1	13.2	13.9	13.1	13.1	170
175							11.7	13.1		12.5	12.9		13.1	13	13.2	13.5	12.9	13.1	175
180							11.5	13.1		12.1	12.9		12.7	12.9	13.2	13.2	12.8	13.1	180
185										11.8	12.9		12.4	12.7	13.2	12.8	12.7	13.1	185
190										11.6			12.1	12.7		12.4	12.6	13.1	190
195										8.8			11.8	12.7		12	12.4	12.7	195
200													11.6	12.6		11.7	11.8	12.4	200
205													10.1			11.4	11.5		205
210													8.4			10.7	11.2		210
215																9.9	10.4		215
220																8.6			220
225																5.3			225

* adapter - pièce d'adaptateur

t_259_104.13151 / 33151_00_000

Lifting capacities

Forces de levage

TNZF 72 ft

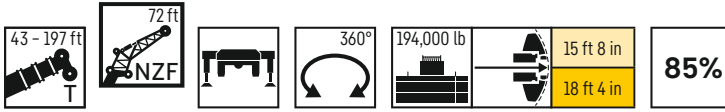

	170 ft + 3.3 ft*			180 ft + 3.3 ft*			184 ft + 3.3 ft*			194 ft + 3.3 ft*			197 ft + 3.3 ft*			
	0°	22,5°	45°	0°	22,5°	45°	0°	22,5°	45°	0°	22,5°	45°	0°	22,5°	45°	
50	25															50
55	24.5			20.5			20.9			18.8			18.5			55
60	23.9			20.2			20.5			18.6			18.3			60
65	23.3			19.9			20.2			18.4			18.1			65
70	22.7			19.6			19.8			18.1			17.8			70
75	22.2			19.2			19.5			17.9			17.6			75
80	21.6	17.9		18.9			19.2			17.6			17.4			80
85	21	17.4		18.6	15.6		18.8	16.1		17.4			17.1			85
90	20.5	17		18.2	15.2		18.5	15.7		17.1	15		16.9	14.9		90
95	20	16.7		17.8	14.8		18.2	15.2		16.8	14.6		16.6	14.5		95
100	19.5	16.3	14.5	17.4	14.4	12.3	17.8	14.9		16.6	14.2		16.4	14.2		100
105	19	16	14.3	16.9	14	12.1	17.5	14.5	12.4	16.3	13.9	12	16.1	13.8		105
110	18.6	15.7	14	16.4	13.6	11.9	17.2	14.1	12.2	15.9	13.5	11.8	15.8	13.5	11.8	110
115	18.1	15.3	13.9	15.9	13.3	11.7	16.8	13.8	12	15.5	13.2	11.6	15.4	13.2	11.6	115
120	17.7	15.1	13.7	15.4	13	11.5	16.4	13.4	11.8	15.1	12.9	11.4	15	12.9	11.4	120
125	17.3	14.8	13.6	14.9	12.7	11.3	15.9	13.1	11.6	14.7	12.6	11.2	14.7	12.6	11.2	125
130	17	14.5	13.4	14.5	12.4	11.1	15.4	12.9	11.4	14.3	12.4	11.1	14.3	12.4	11.1	130
135	16.6	14.3	13.3	14	12.1	11	15	12.6	11.3	13.9	12.1	10.9	13.9	12.1	10.9	135
140	16.3	14.1	13.2	13.6	11.9	10.9	14.5	12.3	11.2	13.5	11.9	10.8	13.5	11.9	10.8	140
145	15.9	13.9	13.1	13.1	11.7	10.7	14.1	12.1	11.1	13.1	11.7	10.7	13.1	11.7	10.7	145
150	15.5	13.7	13	12.7	11.4	10.6	13.7	11.8	10.9	12.8	11.4	10.6	12.7	11.4	10.6	150
155	15.2	13.5	13	12.3	11.2	10.5	13.3	11.6	10.8	12.4	11.2	10.5	12.4	11.2	10.5	155
160	14.8	13.3	12.9	12	11	10.4	12.9	11.4	10.8	12	11	10.4	12	11	10.4	160
165	14.5	13.1	12.9	11.6	10.8	10.4	12.6	11.2	10.7	11.7	10.8	10.3	11.7	10.8	10.3	165
170	14.1	12.9	12.9	11.2	10.6	10.3	12.2	11.1	10.6	11.3	10.6	10.3	11.3	10.6	10.2	170
175	13.7	12.8	12.9	10.9	10.4	10.2	11.9	10.9	10.6	11	10.4	10.2	11	10.4	10.2	175
180	13.4	12.7	12.9	10.5	10.1	10.1	11.6	10.7	10.5	10.7	10.2	10.2	10.6	10.2	10.1	180
185	13.1	12.5	12.9	10.1	9.9	10	11.3	10.6	10.5	10.3	10	10.1	10.3	10	10	185
190	12.4	12.4	12.9	9.7	9.7	9.9	11	10.4	10.5	10	9.8	9.9	10	9.8	9.9	190
195	11.7	12.2	12.9	9.4	9.5	9.7	10.7	10.3	10.5	9.6	9.6	9.8	9.6	9.6	9.8	195
200	10.9	11.9	12.2	9	9.2	9.5	10.5	10.1	10.4	9.3	9.4	9.6	9.3	9.4	9.7	200
205	10.2	11.1	11.3	8.7	8.9	9.2	10.2	10	10.4	9	9.1	9.4	9	9.1	9.4	205
210	9.7	10.3	10.4	8.4	8.6	8.9	9.9	9.8	10.3	8.7	8.8	9.1	8.7	8.8	9.2	210
215	9.4	9.6		8.1	8.3	8.6	9.3	9.6	10.1	8.4	8.6	8.9	8.4	8.6	8.9	215
220	9.1	9.3		7.8	8	8.2	8.7	9.4	9.5	8.1	8.3	8.6	8.1	8.3	8.7	220
225	8.9	9.1		7.5	7.7		8.1	8.8	8.7	7.9	8	8.3	7.8	8.1	8.4	225
230	8.2	7.5		7.3	7.5		7.6	8.1		7.5	7.8	8.1	7.4	7.8	8.1	230
235	6.1			7.1	7.3		7.2	7.5		7.1	7.5		6.9	7.4	7.4	235
240				6.8	7.1		6.7	7		6.6	7.1		6.5	6.9		240
245				5.1			5.5			6.2	6.6		6.1	6.5		245
250							3.5			5.8	6.1		5.7	6		250
255										4.5			4.9	5.5		255
260										2.4			3.2			260

* adapter - pièce d'adaptateur

t_259_104_13151 / 33151_00_000

Lifting capacities

Forces de levage

TNZF 95 ft

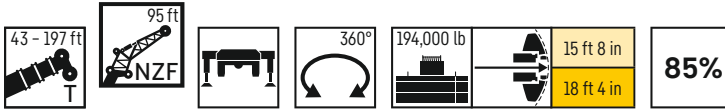

	43 ft + 3.3 ft*			99 ft + 3.3 ft*			114 ft + 3.3 ft*			128 ft + 3.3 ft*			142 ft + 3.3 ft*			156 ft + 3.3 ft*			
	95 ft																		
	0°	22,5°	45°	0°	22,5°	45°	0°	22,5°	45°	0°	22,5°	45°	0°	22,5°	45°	0°	22,5°	45°	
22	31.3																		22
24	31.2																		24
26	30.4																		26
28	29.5																		28
30	28.6																		30
32	27.8																		32
34	26.9			31.1															34
36	26.1			30.6			29.6												36
38	25.4			30			29.1												38
40	24.6			29.3			28.6			26.9									40
45	22.9			27.8			27.3			26			24.2						45
50	21.4			26.3			26			24.9			23.4			21.3			50
55	19.9			25			24.7			23.9			22.6			20.8			55
60	18.5	16.3		23.7			23.6			22.9			21.7			20.2			60
65	17.2	15.4		22.5			22.5			22			20.9			19.6			65
70	15.8	14.5		21.5	16.3		21.5			21.1			20.2			19			70
75	14.6	13.8		20.4	15.7		20.6	15.7		20.2			19.4			18.5			75
80	13.5	13		19.4	15.1		19.6	15.1		19.4	14.9		18.8			17.9			80
85	12.6	12.3	11.1	18.4	14.5		18.8	14.6		18.7	14.4		18.1	14.1		17.4			85
90	11.7	11.7	10.6	17.5	14		18	14		17.9	14		17.5	13.7		16.9	13.6		90
95	11	11.1	10.2	16.5	13.5		17.2	13.6		17.2	13.5		16.9	13.3		16.4	13.2		95
100	10.3	10.5	9.8	15.6	13	10.8	16.4	13.1	10.8	16.6	13.1		16.3	12.9		15.9	12.9		100
105	9.7	10.1	9.5	14.7	12.5	10.5	15.6	12.7	10.5	15.9	12.7	10.5	15.7	12.5		15.5	12.5		105
110	9.1	9.7	9.2	13.9	12.1	10.2	14.8	12.3	10.3	15.3	12.3	10.2	15.2	12.2	10.1	15	12.2		110
115	8.6	9.3	9	13.2	11.7	10	14.1	11.9	10	14.6	11.9	10	14.7	11.9	9.9	14.6	12	10.4	115
120	8.1	8.9	8.8	12.5	11.3	9.8	13.4	11.5	9.8	14	11.6	9.8	14.1	11.5	9.7	14.2	11.7	10.2	120
125	7.7	8.6	8.8	12	10.9	9.5	12.8	11.2	9.6	13.4	11.2	9.6	13.6	11.2	9.6	13.8	11.4	10.1	125
130	7.4	8.5		11.4	10.5	9.4	12.2	10.8	9.4	12.8	10.9	9.4	13.1	10.9	9.4	13.4	11.2	9.9	130
135	7.2			10.9	10.2	9.2	11.6	10.5	9.3	12.2	10.6	9.3	12.6	10.6	9.2	13.1	10.9	9.7	135
140				10.4	9.9	9.1	11.1	10.2	9.1	11.7	10.3	9.1	12.1	10.4	9.1	12.7	10.7	9.6	140
145				9.9	9.7	9	10.7	9.9	9	11.2	10.1	9	11.7	10.1	9	12.4	10.5	9.5	145
150				9.5	9.4	8.9	10.2	9.7	8.9	10.8	9.8	8.9	11.2	9.9	8.9	12.1	10.2	9.3	150
155				9.1	9.2	8.8	9.8	9.4	8.8	10.4	9.6	8.8	10.8	9.6	8.8	11.8	10.1	9.2	155
160				8.7	9	8.8	9.4	9.2	8.7	10	9.3	8.7	10.4	9.4	8.7	11.5	9.9	9.1	160
165				8.4	8.8	8.8	9.1	9	8.7	9.6	9.1	8.7	10	9.2	8.6	11.2	9.7	9.1	165
170				8.1	8.6		8.7	8.8	8.7	9.3	8.9	8.6	9.7	9	8.5	10.8	9.5	9	170
175				7.8	8.5		8.4	8.6	8.7	8.9	8.8	8.6	9.4	8.9	8.5	10.5	9.4	8.9	175
180				7.5	8.5		8.1	8.5		8.6	8.6	8.6	9.1	8.7	8.5	10.1	9.2	8.9	180
185				7.3	8.5		7.9	8.4		8.4	8.5	8.6	8.8	8.5	8.5	9.8	9.1	8.9	185
190				7.2			7.6	8.4		8.1	8.4	8.6	8.5	8.4	8.5	9.5	8.9	8.9	190
195							7.4	8.4		7.9	8.3		8.2	8.3	8.5	9.3	8.8	8.9	195
200							7.3			7.6	8.3		8	8.2	8.5	9	8.7	8.9	200
205							7.2			7.5	8.2		7.8	8.2	8.5	8.7	8.6	8.9	205
210										7.3	8.2		7.6	8.1		8.5	8.5	8.9	210
215										7.2			7.5	8.1		8.3	8.5	8.9	215
220										6.6			7.3	8.1		8.1	8.4	8.9	220
225													7.2	8.1		7.9	8.4		225
230													6.7			7.7	8.4		230
235													3.5			7.6	8.4		235
240																6.9			240
245																5.7			245

* adapter - pièce d'adaptateur

t_259_104_15151 / 35151_00_000

Lifting capacities

Forces de levage

TNZF 95 ft

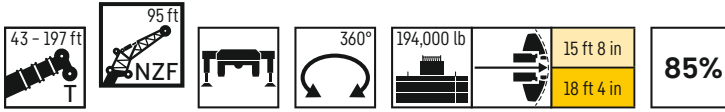

	170 ft + 3.3 ft*			180 ft + 3.3 ft*			184 ft + 3.3 ft*			194 ft + 3.3 ft*			197 ft + 3.3 ft*			
	0°	22,5°	45°	0°	22,5°	45°	0°	22,5°	45°	0°	22,5°	45°	0°	22,5°	45°	
55	18,4															55
60	18			15,3			15,6			14,1						60
65	17,6			15			15,3			13,9			13,6			65
70	17,2			14,8			15			13,7			13,4			70
75	16,8			14,5			14,7			13,5			13,2			75
80	16,4			14,2			14,4			13,3			13			80
85	15,9			14			14,2			13			12,8			85
90	15,6			13,7			13,9			12,8			12,6			90
95	15,2	12,6		13,4			13,6			12,6			12,4			95
100	14,8	12,3		13,2	11		13,3	11,3		12,4			12,2			100
105	14,4	12		12,9	10,6		13,1	11		12,2	10,5		12	10,5		105
110	14,1	11,7		12,6	10,3		12,8	10,7		11,9	10,2		11,8	10,2		110
115	13,7	11,5		12,4	10,1		12,5	10,4		11,7	10		11,6	9,9		115
120	13,4	11,2	10	12,1	9,8		12,3	10,1		11,5	9,7		11,4	9,7		120
125	13,1	11	9,8	11,9	9,5	8	12	9,9	8,3	11,3	9,4	8	11,2	9,4		125
130	12,8	10,7	9,7	11,6	9,3	7,9	11,8	9,6	8,1	11,1	9,2	7,9	11	9,2	7,8	130
135	12,5	10,5	9,6	11,2	9	7,8	11,6	9,4	8	10,9	9	7,7	10,8	9	7,7	135
140	12,2	10,4	9,4	10,9	8,8	7,6	11,3	9,1	7,9	10,7	8,8	7,6	10,6	8,8	7,6	140
145	11,9	10,2	9,3	10,6	8,6	7,5	11,1	8,9	7,7	10,5	8,6	7,5	10,4	8,6	7,5	145
150	11,6	10	9,2	10,3	8,4	7,4	10,8	8,7	7,6	10,3	8,4	7,4	10,2	8,4	7,4	150
155	11,4	9,8	9,1	10	8,2	7,3	10,5	8,5	7,5	10	8,2	7,3	10	8,2	7,3	155
160	11,1	9,6	9	9,7	8	7,3	10,2	8,3	7,4	9,8	8	7,2	9,7	8	7,2	160
165	10,9	9,5	8,9	9,5	7,9	7,2	9,9	8,2	7,4	9,5	7,9	7,2	9,5	7,9	7,2	165
170	10,7	9,3	8,9	9,2	7,7	7,1	9,6	8	7,3	9,3	7,7	7,1	9,2	7,7	7,1	170
175	10,4	9,2	8,8	8,9	7,6	7,1	9,4	7,8	7,2	9	7,6	7	9	7,6	7	175
180	10,2	9,1	8,8	8,7	7,4	7	9,1	7,7	7,2	8,8	7,5	7	8,8	7,5	7	180
185	9,9	8,9	8,7	8,4	7,3	7	8,9	7,6	7,1	8,5	7,4	6,9	8,5	7,3	7	185
190	9,7	8,8	8,7	8,2	7,2	6,9	8,7	7,4	7,1	8,3	7,2	6,9	8,3	7,2	6,9	190
195	9,4	8,7	8,7	8	7,1	6,9	8,5	7,3	7,1	8,1	7,1	6,9	8,1	7,1	6,9	195
200	9,2	8,6	8,7	7,7	7	6,9	8,3	7,3	7,1	7,9	7	6,9	7,9	7	6,9	200
205	9	8,5	8,7	7,5	6,9	6,9	8,1	7,2	7,1	7,7	7	6,8	7,7	7	6,9	205
210	8,7	8,4	8,7	7,3	6,8	6,9	7,9	7,1	7,1	7,5	6,9	6,8	7,5	6,9	6,8	210
215	8,5	8,4	8,7	7,1	6,8	6,9	7,7	7	7,1	7,3	6,8	6,8	7,3	6,8	6,8	215
220	8,3	8,3	8,7	6,9	6,7	6,9	7,6	6,9	7,1	7,1	6,8	6,8	7,1	6,7	6,8	220
225	8,1	8,3	8,7	6,7	6,6	6,9	7,4	6,9	7,1	6,9	6,7	6,8	6,9	6,7	6,8	225
230	7,6	8,3	8,6	6,5	6,6	6,9	7,3	6,9	7,1	6,7	6,6	6,8	6,7	6,6	6,8	230
235	7,2	7,9		6,2	6,5	6,7	7,2	6,8	7,1	6,5	6,5	6,8	6,5	6,6	6,8	235
240	6,9	7,3		6,1	6,3		6,9	6,8	7,1	6,3	6,4	6,7	6,3	6,4	6,8	240
245	6,7	6,8		5,9	6,1		6,5	6,8		6,1	6,3	6,6	6,1	6,3	6,6	245
250	6,6	6,8		5,7	5,9		6,1	6,6		5,9	6,1	6,4	5,8	6,1	6,4	250
255	5,4			5,5	5,7		5,7	6,2		5,6	5,9		5,4	6	6,1	255
260	3,4			5,4			5,3	5,7		5,2	5,7		5,1	5,6		260
265				4,5			4,6			4,9	5,3		4,7	5,2		265
270				2,2			3			4,5	4,9		4,3	4,8		270
275										3,6			3,8	4,3		275
280													2,4			280

* adapter - pièce d'adaptateur

t_259_104_15151 / 35151_00_000

Lifting capacities

Forces de levage

TNZF 118 ft

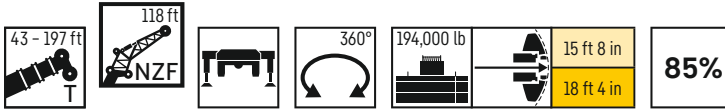

	43 ft + 3.3 ft*			99 ft + 3.3 ft*			114 ft + 3.3 ft*			128 ft + 3.3 ft*			142 ft + 3.3 ft*			156 ft + 3.3 ft*			
	118 ft																		
	0°	22,5°	45°	0°	22,5°	45°	0°	22,5°	45°	0°	22,5°	45°	0°	22,5°	45°	0°	22,5°	45°	
26	22.9																		26
28	22.8																		28
30	22.3																		30
32	21.8																		32
34	21.4																		34
36	20.9																		36
38	20.4			22.8															38
40	19.9			22.4		21.6													40
45	18.7			21.5		20.9				19.7									45
50	17.6			20.6		20.1				19.1			17.8						50
55	16.6			19.7		19.3				18.5			17.3			15.7			55
60	15.6			18.9		18.5				17.8			16.7			15.3			60
65	14.7			18		17.8				17.2			16.2			14.9			65
70	13.8			17.2		17.1				16.5			15.7			14.5			70
75	13	11.7		16.5		16.4				15.9			15.2			14.1			75
80	12.2	11		15.7		15.7				15.3			14.7			13.7			80
85	11.4	10.5		15	11.8		15.1			14.8			14.2			13.3			85
90	10.6	9.9		14.4	11.4		14.5	11.3		14.2			13.7			12.9			90
95	9.9	9.5		13.8	10.9		13.9	10.9		13.7	10.8		13.3	10.5		12.5			95
100	9.2	9		13.1	10.5		13.3	10.5		13.2	10.4		12.9	10.2		12.2	9.8		100
105	8.6	8.5	7.8	12.6	10.1		12.8	10.2		12.7	10.1		12.4	9.8		11.8	9.5		105
110	8	8.1	7.5	12	9.8		12.3	9.8		12.3	9.7		12	9.6		11.5	9.2		110
115	7.5	7.7	7.2	11.4	9.4		11.8	9.5		11.8	9.4		11.6	9.3		11.1	9		115
120	7.1	7.4	6.9	10.8	9.1	7.6	11.3	9.1	7.6	11.4	9.1		11.2	9		10.8	8.7		120
125	6.7	7.1	6.7	10.2	8.8	7.4	10.8	8.9	7.4	11	8.8	7.4	10.9	8.7		10.5	8.5		125
130	6.4	6.8	6.5	9.7	8.5	7.2	10.3	8.6	7.2	10.6	8.6	7.2	10.5	8.5	7.2	10.2	8.3		130
135	6.1	6.6	6.4	9.2	8.2	7.1	9.8	8.3	7.1	10.2	8.3	7.1	10.2	8.3	7	9.9	8	6.9	135
140	5.8	6.3	6.2	8.7	7.9	6.9	9.3	8.1	6.9	9.8	8.1	6.9	9.9	8	6.9	9.6	7.8	6.8	140
145	5.5	6.1	6.2	8.3	7.6	6.8	8.9	7.8	6.8	9.4	7.9	6.8	9.5	7.8	6.8	9.3	7.7	6.7	145
150	5.3	6	6.2	7.9	7.4	6.6	8.5	7.6	6.7	8.9	7.6	6.7	9.2	7.6	6.7	9.1	7.5	6.6	150
155	5.1	5.9		7.6	7.2	6.5	8.1	7.4	6.6	8.6	7.4	6.6	8.8	7.4	6.6	8.8	7.3	6.5	155
160				7.2	7	6.4	7.7	7.2	6.5	8.2	7.3	6.5	8.5	7.3	6.5	8.5	7.2	6.4	160
165				6.9	6.8	6.3	7.4	7	6.4	7.9	7.1	6.4	8.2	7.1	6.4	8.3	7	6.3	165
170				6.7	6.7	6.3	7.2	6.8	6.3	7.6	6.9	6.3	7.9	7	6.3	8	6.9	6.2	170
175				6.4	6.5	6.2	6.9	6.7	6.2	7.3	6.8	6.2	7.6	6.8	6.2	7.7	6.8	6.2	175
180				6.2	6.4	6.2	6.7	6.5	6.2	7	6.6	6.2	7.3	6.7	6.2	7.5	6.6	6.1	180
185				6	6.2		6.4	6.4	6.2	6.8	6.5	6.1	7.1	6.5	6.1	7.3	6.5	6.1	185
190				5.8	6.1		6.2	6.3	6.2	6.6	6.3	6.1	6.9	6.4	6.1	7.1	6.4	6	190
195				5.6	6		6	6.1		6.4	6.2	6.1	6.6	6.3	6	6.8	6.3	6	195
200				5.4	6		5.8	6.1		6.2	6.1	6.1	6.4	6.2	6	6.6	6.2	5.9	200
205				5.3	5.9		5.6	6		6	6	6.1	6.3	6.1	6	6.5	6.1	5.9	205
210				5.1			5.5	5.9		5.8	6	6.1	6.1	6	6	6.3	6	5.9	210
215				5			5.3	5.9		5.6	5.9		5.9	5.9	6	6.1	5.9	5.9	215
220							5.2			5.5	5.8		5.8	5.8	6	6	5.9	5.9	220
225							5.1			5.4	5.8		5.6	5.8	6	5.8	5.8	5.9	225
230										5.2	5.8		5.5	5.7		5.7	5.7	5.9	230
235										5.1			5.3	5.7		5.6	5.7	5.9	235
240										5			5.2	5.7		5.4	5.6		240
245													5.1	5.7		5.3	5.6		245
250													5			5.2	5.6		250
255													4.8			5.1	5.6		255
260																5	5.6		260
265																4.8			265
270																2.8			270

* adapter - pièce d'adaptateur

t.259_104_18151 / 38151_00_000

Lifting capacities

Forces de levage

TNZF 118 ft

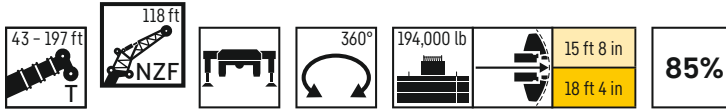

	170 ft + 3.3 ft*			180 ft + 3.3 ft*			184 ft + 3.3 ft*			194 ft + 3.3 ft*			197 ft + 3.3 ft*			
	0°	22,5°	45°	0°	22,5°	45°	0°	22,5°	45°	0°	22,5°	45°	0°	22,5°	45°	
60	13.6															60
65	13.3			11.3			11.5			10.3						65
70	13			11.1			11.3			10.2			10			70
75	12.7			10.9			11			10			9.8			75
80	12.4			10.7			10.8			9.9			9.7			80
85	12.1			10.4			10.6			9.7			9.5			85
90	11.8			10.2			10.4			9.5			9.4			90
95	11.5			10			10.2			9.4			9.2			95
100	11.2			9.8			10			9.2			9			100
105	10.9			9.6			9.8			9			8.9			105
110	10.6	8.8		9.4			9.6			8.8			8.7			110
115	10.4	8.5		9.2	7.7		9.3	7.9		8.7			8.5			115
120	10.1	8.3		9	7.5		9.1	7.7		8.5	7.4		8.4	7.4		120
125	9.8	8.1		8.8	7.3		8.9	7.5		8.3	7.2		8.2	7.2		125
130	9.6	7.9		8.6	7.1		8.7	7.3		8.2	7		8.1	7		130
135	9.3	7.7		8.4	6.9		8.5	7.1		8	6.9		7.9	6.9		135
140	9.1	7.5	6.7	8.2	6.8		8.3	7		7.9	6.7		7.8	6.7		140
145	8.9	7.4	6.6	8.1	6.6	5.6	8.2	6.8	5.8	7.7	6.6		7.6	6.5		145
150	8.6	7.3	6.5	7.9	6.4	5.5	8	6.7	5.7	7.6	6.4	5.5	7.5	6.4	5.5	150
155	8.4	7.1	6.4	7.7	6.3	5.5	7.8	6.5	5.6	7.4	6.3	5.4	7.4	6.3	5.4	155
160	8.2	7	6.3	7.5	6.2	5.4	7.7	6.4	5.5	7.3	6.1	5.3	7.2	6.1	5.3	160
165	8	6.9	6.2	7.3	6	5.3	7.5	6.2	5.4	7.2	6	5.3	7.1	6	5.2	165
170	7.8	6.8	6.1	7.1	5.9	5.2	7.3	6.1	5.4	7	5.9	5.2	7	5.9	5.2	170
175	7.7	6.6	6.1	6.9	5.8	5.1	7.2	6	5.3	6.9	5.8	5.1	6.9	5.8	5.1	175
180	7.5	6.5	6	6.8	5.6	5.1	7	5.8	5.2	6.8	5.6	5.1	6.7	5.6	5.1	180
185	7.3	6.4	6	6.6	5.5	5	6.8	5.7	5.2	6.6	5.5	5	6.6	5.5	5	185
190	7.1	6.3	5.9	6.4	5.4	5	6.7	5.6	5.1	6.5	5.4	5	6.5	5.4	4.9	190
195	6.9	6.2	5.9	6.3	5.3	4.9	6.5	5.5	5	6.3	5.4	4.9	6.3	5.4	4.9	195
200	6.8	6.1	5.9	6.1	5.2	4.9	6.4	5.4	5	6.2	5.3	4.9	6.2	5.3	4.9	200
205	6.6	6	5.9	6	5.1	4.8	6.2	5.3	5	6.1	5.2	4.8	6.1	5.2	4.8	205
210	6.4	5.9	5.8	5.8	5.1	4.8	6.1	5.3	4.9	5.9	5.1	4.8	5.9	5.1	4.8	210
215	6.2	5.9	5.8	5.7	5	4.8	5.9	5.2	4.9	5.8	5	4.8	5.8	5	4.8	215
220	6.1	5.8	5.8	5.6	4.9	4.8	5.8	5.1	4.9	5.7	4.9	4.8	5.7	4.9	4.7	220
225	6	5.7	5.8	5.5	4.8	4.8	5.7	5	4.9	5.6	4.9	4.7	5.6	4.9	4.7	225
230	5.8	5.7	5.8	5.4	4.8	4.8	5.6	4.9	4.9	5.4	4.8	4.7	5.4	4.8	4.7	230
235	5.7	5.6	5.8	5.3	4.7	4.8	5.5	4.9	4.9	5.3	4.7	4.7	5.3	4.7	4.7	235
240	5.6	5.6	5.8	5.1	4.7	4.8	5.4	4.8	4.9	5.2	4.7	4.7	5.2	4.7	4.7	240
245	5.4	5.5	5.8	5	4.6	4.8	5.2	4.8	4.9	5.1	4.6	4.7	5.1	4.7	4.7	245
250	5.3	5.5		4.9	4.6	4.8	5.2	4.8	4.9	5	4.6	4.7	5	4.6	4.7	250
255	5.2	5.5		4.7	4.6	4.8	5.1	4.7	4.9	4.9	4.6	4.7	4.9	4.6	4.7	255
260	5.2	5.5		4.6	4.6		5	4.7	4.9	4.8	4.5	4.7	4.8	4.6	4.7	260
265	5	5.5		4.4	4.6		4.9	4.7		4.7	4.5	4.7	4.6	4.5	4.7	265
270	4.8	5.1		4.3	4.5		4.7	4.7		4.5	4.5	4.7	4.3	4.5	4.7	270
275	4.5			4.2	4.3		4.3	4.7		4.1	4.4		3.9	4.5		275
280	3			4	4.2		4	4.6		3.8	4.4		3.6	4.3		280
285				3.5			3.4	4.1		3.4	4.1		3.3	4		285
290										3.1	3.7		2.9	3.5		290
295										2.4	3.2		2.5	3.1		295

* adapter - pièce d'adaptateur

t.259_104_18151 / 38151_00_000

Lifting capacities

Forces de levage

TNZF 141 ft

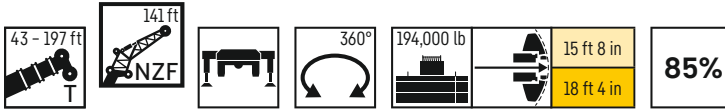

	43 ft + 3.3 ft*			99 ft + 3.3 ft*			114 ft + 3.3 ft*			128 ft + 3.3 ft*			142 ft + 3.3 ft*			156 ft + 3.3 ft*				
	141 ft																			
	0°	22,5°	45°	0°	22,5°	45°	0°	22,5°	45°	0°	22,5°	45°	0°	22,5°	45°	0°	22,5°	45°		
30	17.4																			30
32	17.3																			32
34	17																			34
36	16.7																			36
38	16.4																			38
40	16																			40
45	15.2			17			16.3													45
50	14.4			16.3			15.8			14.9										50
55	13.6			15.7			15.2			14.4			13.4							55
60	12.8			15.1			14.7			14			13			11.8				60
65	12			14.4			14.1			13.5			12.6			11.5				65
70	11.3			13.8			13.6			13			12.2			11.2				70
75	10.7			13.2			13			12.6			11.8			10.9				75
80	10.1			12.6			12.5			12.1			11.5			10.6				80
85	9.5	8.5		12			12			11.6			11.1			10.3				85
90	8.8	8.1		11.5			11.5			11.2			10.7			9.9				90
95	8.2	7.6		11			11			10.8			10.3			9.6				95
100	7.6	7.3		10.5	8.2		10.6	8.2		10.4			10			9.3				100
105	7.2	6.9		10	7.9		10.1	7.9		10	7.7		9.6			9				105
110	6.7	6.6		9.6	7.6		9.7	7.6		9.6	7.5		9.3	7.3		8.8				110
115	6.3	6.3		9.1	7.3		9.3	7.3		9.2	7.2		8.9	7.1		8.5	6.8			115
120	5.9	6		8.6	7.1		8.9	7.1		8.9	7		8.6	6.9		8.2	6.6			120
125	5.6	5.7	5.3	8.1	6.8		8.5	6.8		8.5	6.8		8.4	6.7		7.9	6.4			125
130	5.3	5.5	5.1	7.7	6.6		8.1	6.6		8.2	6.6		8.1	6.5		7.7	6.3			130
135	5	5.2	4.9	7.3	6.3		7.7	6.4		7.9	6.4		7.8	6.3		7.5	6.1			135
140	4.7	5	4.7	7	6.1	5.2	7.3	6.2	5.2	7.6	6.2		7.5	6.1		7.3	6			140
145	4.4	4.8	4.5	6.6	5.9	5	7	6	5	7.3	6	5	7.3	5.9		7.1	5.8			145
150	4.2	4.6	4.4	6.3	5.7	4.9	6.7	5.8	4.9	7	5.8	4.9	7.1	5.8	4.9	6.9	5.7			150
155	4	4.4	4.3	6	5.5	4.8	6.4	5.6	4.8	6.7	5.7	4.8	6.8	5.6	4.7	6.7	5.5	4.7		155
160	3.8	4.2	4.2	5.7	5.3	4.7	6.1	5.5	4.7	6.4	5.5	4.7	6.6	5.5	4.7	6.5	5.4	4.6		160
165	3.6	4.1	4.1	5.5	5.2	4.6	5.9	5.3	4.6	6.1	5.4	4.6	6.3	5.3	4.6	6.3	5.3	4.5		165
170	3.4	4	4.1	5.2	5	4.5	5.6	5.1	4.5	5.9	5.2	4.5	6.1	5.2	4.5	6.2	5.1	4.4		170
175	3.3	3.9		5	4.9	4.4	5.4	5	4.4	5.7	5.1	4.4	5.9	5.1	4.4	6	5	4.3		175
180	3.1	3.9		4.8	4.7	4.3	5.2	4.8	4.3	5.5	4.9	4.3	5.7	4.9	4.3	5.8	4.9	4.2		180
185				4.6	4.6	4.2	5	4.7	4.3	5.2	4.8	4.2	5.5	4.8	4.2	5.6	4.8	4.2		185
190				4.4	4.5	4.1	4.8	4.6	4.2	5	4.7	4.2	5.2	4.7	4.2	5.4	4.6	4.1		190
195				4.2	4.3	4.1	4.6	4.5	4.1	4.9	4.5	4.1	5.1	4.6	4.1	5.2	4.5	4.1		195
200				4.1	4.2	4.1	4.4	4.3	4.1	4.7	4.4	4.1	4.9	4.4	4.1	5	4.4	4		200
205				3.9	4.1	4.1	4.2	4.2	4	4.5	4.3	4	4.7	4.3	4	4.9	4.3	4		205
210				3.7	4		4.1	4.1	4	4.3	4.2	4	4.6	4.2	4	4.7	4.2	3.9		210
215				3.6	4		3.9	4.1	4	4.2	4.1	4	4.4	4.2	3.9	4.5	4.1	3.9		215
220				3.5	3.9		3.8	4		4	4	4	4.3	4.1	3.9	4.4	4.1	3.9		220
225				3.3	3.9		3.6	3.9		3.9	4	4	4.1	4	3.9	4.3	4	3.9		225
230				3.2			3.5	3.9		3.8	3.9	4	4	3.9	3.9	4.1	3.9	3.8		230
235				3.2			3.4	3.8		3.6	3.9		3.8	3.9	3.9	4	3.9	3.8		235
240							3.3	3.8		3.5	3.8		3.7	3.8	3.9	3.9	3.8	3.8		240
245							3.2			3.4	3.8		3.6	3.8	3.9	3.8	3.7	3.8		245
250							3.1			3.3	3.7		3.5	3.7		3.7	3.7	3.8		250
255										3.2	3.7		3.4	3.7		3.6	3.7	3.8		255
260										3.2			3.3	3.7		3.5	3.6			260
265										3.1			3.2	3.7		3.4	3.6			265
270													3.2			3.3	3.6			270
275													3.1			3.2	3.6			275
280																3.1	3.6			280
285																3.1				285
290																2.6				290

* adapter - pièce d'adaptateur

t_259_104_22151 / 42151_00_000

Lifting capacities

Forces de levage

TNZF 141 ft

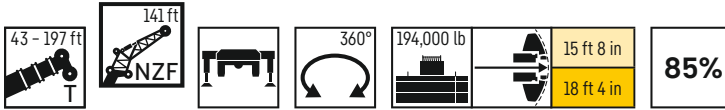

	170 ft + 3.3 ft*			180 ft + 3.3 ft*			184 ft + 3.3 ft*			194 ft + 3.3 ft*			197 ft + 3.3 ft*			
	0°	22,5°	45°	0°	22,5°	45°	0°	22,5°	45°	0°	22,5°	45°	0°	22,5°	45°	
65	10.1															65
70	9.9			8.3			8.4									70
75	9.7			8.1			8.2			7.4			7.3			75
80	9.4			7.9			8.1			7.3			7.2			80
85	9.2			7.8			7.9			7.2			7.1			85
90	8.9			7.6			7.7			7.1			7			90
95	8.7			7.4			7.6			6.9			6.8			95
100	8.5			7.3			7.4			6.8			6.7			100
105	8.2			7.2			7.3			6.7			6.6			105
110	8			7			7.1			6.6			6.5			110
115	7.8			6.9			7			6.5			6.4			115
120	7.6			6.7			6.8			6.4			6.3			120
125	7.4	6.1		6.6			6.7			6.2			6.1			125
130	7.2	6		6.4	5.5		6.5	5.6		6.1			6			130
135	7	5.9		6.3	5.4		6.4	5.5		6	5.2		5.9	5.2		135
140	6.8	5.7		6.2	5.2		6.3	5.4		5.9	5.1		5.8	5.1		140
145	6.7	5.6		6.1	5.1		6.1	5.2		5.8	5		5.7	5		145
150	6.5	5.4		5.9	4.9		6	5.1		5.7	4.9		5.6	4.9		150
155	6.3	5.3		5.8	4.8		5.9	5		5.5	4.8		5.5	4.8		155
160	6.2	5.2	4.5	5.7	4.7		5.7	4.8		5.4	4.7		5.4	4.6		160
165	6.1	5.1	4.4	5.5	4.5	3.8	5.6	4.7	3.9	5.3	4.5		5.3	4.5		165
170	5.9	5	4.3	5.4	4.4	3.7	5.5	4.6	3.8	5.2	4.4	3.7	5.2	4.4	3.6	170
175	5.8	4.9	4.2	5.3	4.3	3.6	5.4	4.5	3.7	5.1	4.3	3.6	5.1	4.3	3.6	175
180	5.6	4.7	4.2	5.2	4.2	3.5	5.3	4.4	3.7	5	4.2	3.5	5	4.2	3.5	180
185	5.5	4.6	4.1	5.1	4.1	3.5	5.2	4.3	3.6	5	4.1	3.5	4.9	4.1	3.5	185
190	5.3	4.5	4.1	4.9	4	3.4	5.1	4.1	3.5	4.9	4	3.4	4.8	4	3.4	190
195	5.2	4.4	4	4.8	3.9	3.4	5	4.1	3.5	4.8	3.9	3.3	4.7	3.9	3.4	195
200	5	4.3	4	4.7	3.8	3.3	4.8	4	3.4	4.7	3.8	3.3	4.6	3.8	3.3	200
205	4.9	4.3	3.9	4.6	3.7	3.2	4.7	3.9	3.4	4.6	3.7	3.2	4.5	3.7	3.2	205
210	4.8	4.2	3.9	4.4	3.6	3.2	4.6	3.8	3.3	4.5	3.6	3.2	4.4	3.6	3.2	210
215	4.6	4.1	3.8	4.3	3.5	3.2	4.5	3.7	3.3	4.4	3.6	3.2	4.4	3.6	3.2	215
220	4.5	4	3.8	4.2	3.5	3.1	4.4	3.6	3.3	4.3	3.5	3.1	4.2	3.5	3.1	220
225	4.3	3.9	3.8	4.1	3.4	3.1	4.3	3.5	3.2	4.1	3.4	3.1	4.1	3.4	3.1	225
230	4.2	3.9	3.8	4	3.3	3.1	4.2	3.5	3.2	4	3.4	3.1	4	3.3	3.1	230
235	4.1	3.8	3.8	3.9	3.3	3.1	4	3.4	3.2	3.9	3.3	3	3.9	3.3	3	235
240	4	3.7	3.8	3.8	3.2	3	3.9	3.3	3.2	3.8	3.2	3	3.8	3.2	3	240
245	3.9	3.7	3.8	3.7	3.1	3	3.9	3.3	3.1	3.7	3.2	3	3.7	3.2	3	245
250	3.8	3.6	3.8	3.6	3.1	3	3.8	3.2	3.1	3.7	3.1	3	3.7	3.1	3	250
255	3.7	3.6	3.8	3.5	3	3	3.7	3.2	3.1	3.6	3.1	3	3.6	3.1	3	255
260	3.6	3.6	3.8	3.4	3	3	3.6	3.1	3.1	3.5	3	3	3.5	3	3	260
265	3.5	3.5	3.8	3.3	3	3	3.5	3.1	3.1	3.4	3	3	3.4	3	3	265
270	3.4	3.5		3.3	2.9	3	3.4	3.1	3.1	3.3	2.9	3	3.3	2.9	3	270
275	3.3	3.5		3.2	2.9		3.4	3	3.1	3.2	2.9	3	3.3	2.9	3	275
280	3.2	3.5		3.1	2.9		3.3	3		3.1	2.9	3	3.2	2.9	3	280
285	3.2	3.5		2.9	2.9		3.2	3		3	2.9	3	2.9	2.9	3	285
290	3.1	3.5		2.8	2.9		3	3		2.8	2.9		2.6	2.8		290
295	3			2.7	2.9		2.8	3		2.5	2.9		2.3	2.8		295
300				2.5	2.8		2.4	3			2.8			2.8		300
305				2.3				2.7			2.7			2.5		305
310											2.3					310

* adapter - pièce d'adaptateur

t_259_104.22151 / 42151_00_000

Lifting capacities

Forces de levage

TNZF 164 ft

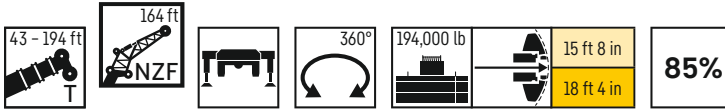

	43 ft + 3.3 ft*			99 ft + 3.3 ft*			114 ft + 3.3 ft*			128 ft + 3.3 ft*			142 ft + 3.3 ft*			156 ft + 3.3 ft*			
	164 ft																		
	0°	22,5°	45°	0°	22,5°	45°	0°	22,5°	45°	0°	22,5°	45°	0°	22,5°	45°	0°	22,5°	45°	
34	12.5																		34
36	12.5																		36
38	12.3																		38
40	12.1																		40
45	11.6																		45
50	11.1			12.1			11.7												50
55	10.6			11.8			11.3			10.7									55
60	10			11.4			11			10.4			9.6						60
65	9.5			11			10.7			10.1			9.4			8.5			65
70	9			10.6			10.3			9.8			9.1			8.3			70
75	8.5			10.1			9.9			9.5			8.8			8			75
80	8.1			9.7			9.5			9.1			8.6			7.8			80
85	7.6			9.3			9.2			8.8			8.3			7.6			85
90	7.2			8.9			8.8			8.5			8			7.4			90
95	6.9			8.6			8.5			8.2			7.8			7.2			95
100	6.5	6		8.2			8.1			7.9			7.5			7			100
105	6.1	5.7		7.8			7.8			7.6			7.3			6.8			105
110	5.7	5.4		7.5			7.5			7.3			7.1			6.6			110
115	5.3	5.2		7.2	5.8		7.2	5.8		7.1			6.8			6.5			115
120	5	4.9		6.9	5.6		6.9	5.6		6.8	5.5		6.6			6.3			120
125	4.6	4.6		6.6	5.4		6.7	5.4		6.6	5.3		6.4	5.1		6.1			125
130	4.3	4.4		6.3	5.2		6.4	5.2		6.4	5.1		6.2	5		5.9	4.8		130
135	4.1	4.2		6	5		6.2	5		6.2	5		6	4.8		5.7	4.6		135
140	3.8	4		5.7	4.8		5.9	4.8		5.9	4.8		5.8	4.7		5.6	4.5		140
145	3.6	3.8	3.5	5.4	4.6		5.6	4.6		5.7	4.6		5.6	4.5		5.4	4.4		145
150	3.4	3.6	3.3	5.1	4.4		5.4	4.5		5.5	4.5		5.5	4.4		5.2	4.2		150
155	3.1	3.4	3.2	4.8	4.3		5.2	4.3		5.3	4.3		5.3	4.3		5.1	4.1		155
160	2.9	3.2	3	4.6	4.1	3.4	4.9	4.1	3.4	5.1	4.2		5.1	4.1		4.9	4		160
165	2.8	3.1	2.9	4.4	3.9	3.3	4.7	4	3.3	4.9	4	3.3	4.9	4		4.8	3.9		165
170	2.6	2.9	2.8	4.2	3.8	3.2	4.4	3.8	3.2	4.7	3.9	3.2	4.8	3.9	3.1	4.6	3.8		170
175	2.4	2.8	2.7	4	3.6	3.1	4.2	3.7	3.1	4.5	3.7	3.1	4.6	3.7	3.1	4.5	3.7	3	175
180	2.3	2.7	2.6	3.8	3.5	3	4	3.6	3	4.2	3.6	3	4.4	3.6	3	4.3	3.5	2.9	180
185	2.2	2.5	2.5	3.6	3.4	2.9	3.8	3.5	2.9	4	3.5	2.9	4.2	3.5	2.9	4.2	3.4	2.8	185
190		2.4	2.5	3.4	3.3	2.8	3.7	3.3	2.9	3.9	3.4	2.9	4	3.4	2.8	4	3.3	2.8	190
195		2.3	2.5	3.2	3.1	2.8	3.5	3.2	2.8	3.7	3.3	2.8	3.8	3.3	2.7	3.9	3.2	2.7	195
200		2.3		3.1	3	2.7	3.3	3.1	2.7	3.5	3.2	2.7	3.7	3.2	2.7	3.7	3.1	2.6	200
205				2.9	2.9	2.6	3.2	3	2.6	3.4	3.1	2.6	3.5	3.1	2.6	3.5	3	2.6	205
210				2.8	2.8	2.6	3	2.9	2.6	3.2	3	2.6	3.4	3	2.6	3.4	2.9	2.5	210
215				2.6	2.7	2.5	2.9	2.8	2.6	3.1	2.9	2.5	3.2	2.9	2.5	3.3	2.8	2.5	215
220				2.5	2.6	2.5	2.7	2.7	2.5	3	2.8	2.5	3.1	2.8	2.5	3.1	2.8	2.4	220
225				2.4	2.5	2.5	2.6	2.6	2.5	2.8	2.7	2.5	2.9	2.7	2.4	3	2.7	2.4	225
230				2.2	2.5	2.5	2.5	2.6	2.5	2.7	2.6	2.4	2.8	2.6	2.4	2.9	2.6	2.4	230
235				2.1	2.4		2.4	2.5	2.5	2.6	2.5	2.4	2.7	2.6	2.4	2.7	2.5	2.3	235
240					2.4		2.3	2.4		2.5	2.5	2.4	2.6	2.5	2.4	2.6	2.5	2.3	240
245					2.3		2.2	2.4		2.3	2.4	2.4	2.5	2.4	2.4	2.5	2.4	2.3	245
250					2.3			2.3		2.2	2.3		2.4	2.4	2.3	2.4	2.4	2.3	250
255								2.3		2.1	2.3		2.2	2.3	2.3	2.3	2.3	2.3	255
260								2.3			2.3		2.1	2.3	2.3	2.2	2.3	2.3	260
265											2.2			2.2		2.1	2.2	2.3	265
270											2.2			2.2			2.2	2.3	270
275											2.2			2.2			2.1	2.3	275
280														2.2			2.1		280
285														2.1			2.1		285

* adapter - pièce d'adaptateur

t.259.104.24151 / 44151.00.000

Lifting capacities

Forces de levage

TNZF 164 ft

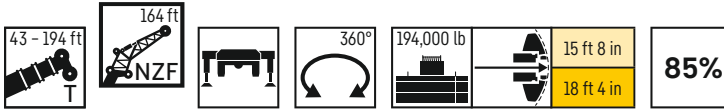

	170 ft + 3.3 ft*			180 ft + 3.3 ft*			184 ft + 3.3 ft*			194 ft + 3.3 ft*		
	0°	22,5°	45°	0°	22,5°	45°	0°	22,5°	45°	0°	22,5°	
70	7.3											70
75	7.1			6			6.1					75
80	7			5.9			6			5.4		80
85	6.8			5.8			5.9			5.3		85
90	6.7			5.7			5.8			5.2		90
95	6.5			5.6			5.7			5.1		95
100	6.4			5.5			5.6			5.1		100
105	6.2			5.4			5.4			5		105
110	6.1			5.2			5.3			4.9		110
115	5.9			5.1			5.2			4.8		115
120	5.8			5			5.1			4.7		120
125	5.6			4.9			5			4.6		125
130	5.5			4.8			4.9			4.5		130
135	5.3			4.7			4.8			4.4		135
140	5.2	4.3		4.6			4.7			4.3		140
145	5	4.1		4.5	3.8		4.5	3.8		4.2		145
150	4.9	4		4.4	3.7		4.4	3.7		4.1		150
155	4.8	3.9		4.2	3.6		4.3	3.6		4	3.4	155
160	4.6	3.8		4.1	3.4		4.2	3.5		3.9	3.3	160
165	4.5	3.7		4	3.3		4.1	3.4		3.8	3.2	165
170	4.4	3.6		4	3.2		4	3.3		3.7	3.1	170
175	4.3	3.5		3.9	3.1		3.9	3.2		3.7	3	175
180	4.1	3.4	2.8	3.8	3		3.8	3.1		3.6	2.9	180
185	4	3.3	2.8	3.7	2.9		3.7	3		3.5	2.8	185
190	3.9	3.2	2.7	3.5	2.8	2.3	3.6	2.9	2.4	3.4	2.7	190
195	3.8	3.1	2.6	3.4	2.7	2.2	3.5	2.8	2.3	3.3	2.6	195
200	3.6	3	2.6	3.3	2.6	2.2	3.4	2.7	2.3	3.2	2.5	200
205	3.5	2.9	2.5	3.2	2.5	2.1	3.3	2.7	2.2	3.1	2.5	205
210	3.4	2.9	2.5	3.1	2.4		3.2	2.6	2.1	3.1	2.4	210
215	3.3	2.8	2.4	3	2.3		3.1	2.5		3	2.3	215
220	3.1	2.7	2.4	2.9	2.3		3	2.4		2.9	2.2	220
225	3	2.6	2.4	2.8	2.2		2.9	2.3		2.8	2.2	225
230	2.9	2.6	2.3	2.7	2.1		2.8	2.3		2.7		230
235	2.8	2.5	2.3	2.6			2.7	2.2		2.6		235
240	2.6	2.4	2.3	2.5			2.6	2.1		2.5		240
245	2.5	2.4	2.2	2.4			2.5			2.4		245
250	2.4	2.3	2.2	2.3			2.4			2.3		250
255	2.3	2.3	2.2	2.2			2.3			2.3		255
260	2.3	2.2	2.2	2.2			2.2			2.2		260
265	2.2	2.2	2.2				2.2			2.1		265
270		2.1	2.2									270
275		2.1	2.2									275
280			2.2									280
285			2.2									285

* adapter - pièce d'adaptateur

t 259_104_24151 / 44151_00_000

Equipment

Crane carrier

Frame	Self-manufactured, torsion-resistant box-type design of high-tensile fine grained structural steel.
Outriggers	4-point supporting system, hydraulically telescopic into horizontal and vertical direction. Operation with remote control, automatic support leveling, electronic inclination display.
Engine	6-cylinder Diesel, make Liebherr, watercooled, output 400 kW (544 h.p.), max. torque 1856 lb-ft. Exhaust emissions acc. to (EU) 2016/1628, EPA/CARB or ECE-R.96. Fuel reservoir: 198 gallons.
Transmission	ZF 12-speed gear box with automatic control system. ZF-intarder fitted directly to the gear. Two-stage transfer case with lockable transfer differential.
Axles	Low maintenance carrier axles, all 5 axles steered. Axle 2, 4 and 5 are equipped with planetary gears, all driven axles with transverse differential locks, axle 4 with longitudinal differential lock.
Suspension	All axles are mounted on hydropneumatic suspension - "Niveaumatik suspension" and are lockable hydraulically.
Tyres	10 tyres. Size of tyres: 445/95 R 25 (16.00 R 25).
Steering	2-circuit system with hydraulic servo steering. Active speed depending rear axle steering, special steering programs for various driving situations.
Brakes	Service brake: all-wheel servo-air brake, all axles are equipped with disc brakes, dual circuit. Additional brakes: exhaust flap brake, Telma Eddy current brake (optional), intarder in gearbox. Hand brake: Spring-loaded, acting on all wheels of axles 2 to 5.
Driver's cab	Spacious corrosion resistant with comfort furnishings, mounted on rubber shock absorbers, safety glazing.
Electrical system	Modern data bus technique, 24 Volt DC.

Crane superstructure

Frame	Liebherr-manufactured, torsionally rigid steel construction made from high-tensile fine-grain steel. Triple-roller slewing rim.
Crane drive	Mechanical drive of the crane hydraulic from the chassis. Variable axial piston pumps with servo control and power regulation.
Control	Electric „Load Sensing“ control, simultaneous operation of 4 working motions, 2 self-centering hand control levers (joy-stick type).
Hoist gear	Axial piston fixed displacement motor, Liebherr hoist drum with integrated planetary gear and spring-loaded static brake.
Luffing gear	1 differential ram with pilot-controlled brake valve.
Slewing gear	Axial piston fixed displacement motor, planetary gear, spring-loaded static brake. Slewing gear invertible from released to locked as standard feature.
Crane cab	Large screen area, compound glass, comfort furnishing, cabin tiltable 20° to rear.
Safety devices	LICCON2 safe load indicator, test system, hoist limit switches, safety valves against rupture of pipes and hoses.
Telescopic boom	1 base section and 5 telescopic sections. All telescopic sections extendable individually by means of the rapid-cycle telescoping system TELEMATIK. Boom length 43 ft to 197 ft.
Counterweight	149,900 lb

Additional equipment

K	Swing away jib 18 ft, 40 ft - 72 ft, 95 ft, 118 ft Adjustment 0°; 22,5°; 45°
NZK	Hydraulically adjustable swing-away jib 18 ft, 40 ft - 72 ft, 95 ft, 118 ft Hydraulically adjustment 0° - 45°
V	Telescopic boom extension 2 x 23 ft
NZF	Fixed lattice jib 26 ft - 164 ft Hydraulic adjustment 0° - 45°
S	Powerful jib 13 ft - 151 ft, 0°
2nd hoist gear	For two-hook operation.
Tyres	10 tyres, size 525/80 R 25 (20.5 R 25).
Drive 10 x 8	Additional drive of the 3 rd axle.
Additional counterweight	44,100 lb for a total counterweight of 194,000 lb.

Other items of equipment available on request.

Équipement

Châssis porteur

Cadre	Châssis résistant à la torsion de fabrication Liebherr, en acier à grains fins très résistant.
Calage	Dispositif de calage horizontal et vertical en 4 points, entièrement déployable hydrauliquement. Utilisation avec commande à distance, mise à niveau automatique du calage, inclinomètre électronique.
Moteur	Moteur diesel, 6 cylindres, fabriqué par Liebherr, à refroidissement par eau, de 400 kW (544 ch), couple max. 1856 lb-ft. Emissions des gaz d'échappement conformes au directive (EU) 2016/1628, EPA/CARB ou ECE-R.96. Capacité du réservoir à carburant: 198 gallons.
Boîte de vitesse	Boîte de vitesses ZF à 12 rapports, mécanisme automatisé à commande. Ralentisseur hydrodynamique ZF directement accouplé à la boîte. Boîte de transfert à 2 étages avec blocage de différentiel.
Essieux	Essieux nécessitant peu d'entretien, les 5 essieux sont directeurs. Les essieux 2, 4 et 5 sont des essieux planétaires, tous les essieux moteurs avec différentiel transversal et l'essieu 4 avec différentiel longitudinal.
Suspension	Suspension hydropneumatique «Niveaumatik» - sur tous les essieux. Chaque essieu peut être bloqué hydrauliquement.
Pneumatiques	10 pneus. Taille: 445/95 R 25 (16.00 R 25).
Direction	2 circuits avec direction assistée hydraulique. Direction active des essieux arrière et dépendante de la vitesse, programmes de direction spéciaux pour les différents modes de déplacement.
Freins	Freins de service : servofrein à air comprimé, tous les essieux sont munis de freins à disque, à 2 circuits. Freins auxiliaire : par clapet sur échappement, frein Telma (option), ralentisseur monté sur boîte de vitesse. Frein de secours et frein à main : par cylindres à ressorts sur les essieux 2 à 5.
Cabine	Spacieuse cabine, traitement anticorrosion, équipement «grand confort», suspension par silentblochs, vitrage de sécurité.
Installation électrique	Technique moderne de transmission de données par BUS de données, courant continu 24 Volts.

Partie tournante

Cadre	Fabrication Liebherr, construction soudée indéformable, en acier à grain fin haute résistance. Couronne d'orientation à triple rangée de rouleaux.
Entraînement	Entraînement mécanique de l'hydraulique de la grue par le châssis de la grue. Pompes réglables à pistons axiaux avec servocommande et réglage de puissance.
Commande	Direction électrique "Load Sensing", 4 mouvements de travail dirigeable simultanément, deux leviers de commande à 4 positions et à auto-centrage.
Mécanisme de levage	Moteur à cylindrée constante et à pistons axiaux. Treuil de marque Liebherr équipé d'un engrenage planétaire et d'un frein d'arrêt commandé par ressort.
Mécanisme de relevage	1 vérin différentiel avec clapet de frein commandé.
Dispositif de rotation	Moteur à cylindrée constante à pistons axiaux, réducteur planétaire, frein d'arrêt commandé par ressort. Commutation en série du mécanisme d'orientation: ouvert et en orientation freinée automatiquement.
Cabine de grue	Large champ de vision, vitrage de sécurité, équipement pour un confort idéal, cabine inclinable de 20° vers l'arrière.
Dispositif de sécurité	Contrôleur de charge LICCON2, système test, fin de course crochet haut, clapets de sécurité en cas de ruptures de flexibles.
Flèche télescopique	Un élément de base et de 5 télescopes. Chaque partie peut être télescopée individuellement à l'aide du système de télescopage séquentiel rapide TELEMATIK. Longueur de flèche: 43 ft - 197 ft.
Contrepoids	149,900 lb

Équipement supplémentaire

K	Flechette pliante 18 ft, 40 ft - 72 ft, 95 ft, 118 ft Positionnement 0°; 22,5°; 45°
NZK	Flechette pliante à positionnement hydraulique 18 ft, 40 ft - 72 ft, 95 ft, 118 ft Positionnement hydraulique à 0° - 45°
V	Rallonge flèche télescopique 2 x 23 ft
NZF	Flechette treillis fixe 26 ft - 164 ft Positionnement hydraulique à 0° - 45°
S	Fléchette particulièrement puissante 13 ft - 151 ft, 0°
2ème mécanisme de levage	Pour l'utilisation du deuxième crochet.
Pneumatiques	10 pneus. Taille: 525/80 R 25 (20.5 R 25).
Entraînement 10 x 8	Essieu 3 est entraîné additionnellement.
Contrepoids additionnel	44,100 lb pour un contrepoids total de 194,000 lb.
Autres équipements supplémentaires sur demande.	

Description of symbols

Explication des symboles



Max. capacity
Capacité max.



Outriggers front
Calage avant



Radius
Portée



Max. hoist height
Hauteur de levage max.



Outriggers rear
Calage arrière



Telescopic boom
Flèche télescopique



Max. radius
Portée max.



Crane superstructure
Partie tournante de la grue



Swing away jib
Fléchette pliante



Tyres
Pneumatiques



infinitely variable
en continu



Hydraulic swing away jib
Fléchette pliante hydraulique



Hookblock/Capacity
Moufle à crochet/Capacité de charge



Rope diameter
Diamètre



Telescopic boom extension
Rallonge flèche télescopique



No. of sheaves
Poulies



Rope length
Longueur du câble



Hydraulic lattice jib
Fléchette treillis hydraulique



No. of lines
Brins



Max. single line pull
Effort au brin maxi.



Powerful jib
Fléchette particulièrement puissante



Weight
Poids



Hoist gear
Treuil de levage



Crane carrier
Châssis porteur



Slewing speeds
Vitesses d'orientation



Driving speed
Vitesse de translation



Boom length
Longueur de la flèche



Gradability
Aptitude à gravir les pentes



Boom position
Position de la flèche



Transmission
Boîte de vitesse



Counterweight
Contrepoids



Gear
Vitesse



Counterweight radius
Rayon de contrepoids



Onroad gear
Vitesse de route



Outriggers
Calage



Crawl speed
Marche lente



Slewing gear / Working area
Mécanisme d'orientation / Plage de travail



Max. supporting forces
Forces d'appui max.



Standard
Norme

Remarks

1. The lifting capacities do not exceed 85 % of the tipping load according to ASME B 30.5. The crane's structural steelwork is in accordance with EN 13000 and ASME B 30.5.
2. For the calculation of the load charts at least a wind speed of 30 ft/s (9 m/s, 20 mph) and regarding the load a sail area of 1 m² per ton load and a wind resistance coefficient of 1.2 on the load have been taken into account. For lifting of loads with large sail areas and/or high wind resistance coefficients the maximum wind speed as stated in the load charts has to be reduced.
3. The lifting capacities stated are valid for lifting operation only (corresponding with crane classification according to ISO 4301-1, crane group A1).
4. Lifting capacities are given in kip.
5. The weight of the hook blocks and hooks is part of the load and therefore it must be deducted from the lifting capacities.
6. Working radii are measured from the slewing center.
7. The stated lengths of the telescopic boom are maximum values and may deviate slightly.
8. The lifting capacities given for the telescopic boom apply if the folding jib is removed.
9. Subject to modification of lifting capacities.
10. Lifting capacities above 295,400 lb / 332,900 lb only with additional pulley block/special equipment.
11. The data of this brochure serves only for general information. All information is provided without warranty. Instructions for the correct commissioning of the crane please take from the operation manual and the load chart book.
12. The illustrations in this brochure may feature accessories and special equipment not included in the standard scope of delivery.

Remarques

1. La capacité de charge ne doit pas dépasser 85 % de la charge de basculement conformément à ASME B 30.5. La structure métallique de la grue est conforme à EN 13000 et ASME B 30.5.
2. Une vitesse de vent de 30 ft/s (9 m/s, 20 mph) minimum, une surface de prise au vent de 1 m² par tonne ainsi qu'un coefficient de résistance au vent de la charge 1,2 sont pris en compte pour le calcul des tableaux de charge. Lorsque des charges ayant une surface de prise au vent et/ou un coefficient de résistance au vent plus élevé(e)(s) sont levées, la vitesse de vent maximale indiquée dans les tableaux de charge doit être réduite.
3. Forces de levage pour application de grue de montage (correspond à la classification de grues selon ISO 4301-1, groupe de grues A1).
4. Les charges sont indiquées en kip.
5. Le poids du crochet de levage resp. de la moufle à crochet est une partie de la charge et doit donc être déduit de la capacité de charge.
6. Les portées sont calculées à partir de l'axe de rotation.
7. Les longueurs indiquées pour la flèche télescopique sont des valeurs maximales et peuvent légèrement varier dans la réalité.
8. Les charges indiquées pour la flèche télescopique sont valables lorsque la fléchette pliante est démontée.
9. Charges données sous réserve de modification.
10. Forces de levage plus de 295,400 lb / 332,900 lb seulement avec moufle additionnel/equipement supplémentaire.
11. Les données de cette brochure sont données à titre informatif. Ces renseignements sont sans garantie. Les consignes relatives à la bonne mise en service de la grue sont disponibles dans le manuel d'utilisation et le manuel de tableaux de charge.
12. Les figures contiennent également des accessoires et des équipements spéciaux non inclus de série dans la livraison.

MyLiebherr

Our MyLiebherr portal is the easy way for you to access Liebherr's digital service world.
Take advantage of extensive basic and additional services for your mobile and crawler cranes.

Avec notre portail MyLiebherr, accédez facilement à l'univers numérique du service de Liebherr.
Bénéficiez dès maintenant d'un service global et de prestations complémentaires pour vos grues mobiles et sur chenilles.



One portal, all services

MyLiebherr



Planning

Crane Finder



Operations

Performance



Planning

Crane Planner 2.0



Operations

Documents



Maintenance

Spare Parts Catalogue



Planning

LICCON Work Planner



Training

Digital Crane Operator



Maintenance

Parts Shop

Proposition 65



WARNING: This product can expose you to chemicals, including exhaust emissions, including lead and lead compounds, which are known to the State of California to cause cancer, birth defects or other reproductive harm.
For more information see: www.P65warnings.ca.gov/diesel

Änderungen vorbehalten · Subject to modification · Sous réserve de modifications · Con riserva di modifiche · Salvo modificaciones · Возможны изменения

Liebherr-Werk Ehingen GmbH · Postfach 1361 · 89582 Ehingen, Germany
+49 73 91 5 02-0 · www.liebherr.com

MyLiebherr



Printed in Germany (2)
lwe-td-259-03-us04-2022